



parkmere

educational & office furniture

Inspiring Solutions

2024/25



parkmere

Inspiring Solutions...



Sales helpline

024 7710 3777

Email

sales@parkmere.com

Web

www.parkmere.com



Head Office & Postal Address:

Parkmere, Santis House, Curriers Close, Charter Avenue
Industrial Estate, Coventry, CV4 8AW

contents



Special Educational Needs Pages 130-147



Phone Lockers Page 158

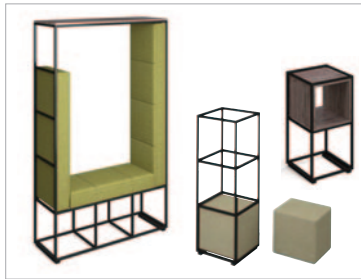

Modular Shelving Pages 344-345



Geneva Dining Chairs Page 193



Lunchbox Trolleys Page 82



Reception & Staffroom Seating Pages 230-231

Classroom Furniture	2-45
Classroom Storage	46-95
Early Years	96-129
SEN	130-147
Cloakrooms & Lockers	148-161
IT Suites	162-177
Dining Furniture	178-201
Libraries & Learning Zones	202-219
Seating	220-291
Receptions	292-305
Office Furniture	306-373
Presentation & Display	374-403
Acoustic Surfaces	404-409
Outdoor Furniture	410-421
Design & Refurbishment	422-443
Index	444-448

Meet some of the new products for 2024



We want to help you get the right products and the best deals, so please look out for products with these highlights.



Calypso Heavy Duty Tables
See Page 8 for details
Available in 6 sizes

Flow Chair See Page 31
Available in 6 heights
& 16 colours

Are your classrooms inspiring places to learn in?
We provide the ideal furniture to maximize learning and space optimization.

Classroom Furniture

Flex Chair & Stax Tables	5	Forum Chair	29
Creative Cluster Tables	6-7	The Profile Chair	30
Calypso	8	Contour Chair	30
Contract Tables	9	Flow Chair	31
Premium Range	10-11	Mono Posture	32-33
Classroom Tables	12-19	Roma Chair	33
Craft Tables	20	Chevron Chair & Stool	34
Work Benches	21	Positive Posture	35
Height Adjustable Desks	22	Ergo Chair	35
Wooden Locker Desks	23	Pennine Posture	36
Teacher's Desks	24-25	Folding Chairs & Trolleys	37
Poly Chairs	26-31	Stools & High Chairs	38-41
The Poly Chair	26	Active Balance Stool	42
Standfast Chair	27	Upholstered Stools	42
Chiltern Chair	27	Study Booths	43
Classic Chair	28	Exam Desks & Chairs	44-45
Atlas Chair	29		

Classroom Furniture

Ordering school furniture can be a daunting task, especially when spending so much of your school budget. If you are kitting out a new classroom or replacing a number of tables and chairs then simply selecting from a catalogue may not be the best option.

We can advise on the best table and chair heights, surfaces and edge options and the best classroom layouts for your needs. We have years of experience and will take all your needs into account - your budget, the age of the pupils, and the type of uses and environment that the furniture will be used in. Whether it is DT benches and stools, IT

seating, or standard classroom furniture you require, we will be happy to advise on health and safety considerations, British Standards, lighting and ergonomics.

There is no obligation to buy from us, but we would welcome the opportunity to provide you with a quote and to prepare layout drawings for you to consider.

We have the expertise to protect you from potentially costly mistakes, so please call us today to discuss your requirements.

Choosing Your Tables

3 Table Styles

Crushbent frame - the best option if the tables need to be stacked frequently, the tables can be slide stacked easily.



Fully welded frame - the most popular choice, strong and durable, the tables will stack in a spiral fashion.



Premium frame - Round leg frame gives an extremely strong and modern, attractive look to the classroom, can be spiral stacked.



3 Edge Styles

MDF edge - Lacquered natural wood edge gives a low cost tamperproof solution.

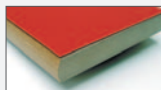

PVC edge - Introduce colour by having a matching or contrasting edge in a wide range of colours, impact resistant.

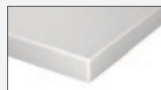

PU (polyurethane) edge - The ultimate choice, spray applied polyurethane gives a seamless, water resistant, textured durable edge to the table.



3 Top Styles

Standard Laminate



10 Colours

Premium Laminate



9 Colours

Dry Wipe Laminate



Accepts drywipe pens

See page 11

Deliveries for the start of the Autumn term

- **Order in May to avoid delay!**
- Please could you help us by ordering classroom furniture required for the start of the Autumn term as soon as possible, ideally by May or early June.
- Please advise us of your school opening times during the summer holiday.
- Please include a site contact & phone number
- Please ensure all details are included on your order to avoid delays in starting production
- Please check our order confirmation carefully, as classroom furniture is made to order
- Please do not dispose of your old furniture until the new arrives!

Table & Chair Heights

Choosing Tables and Chairs Recommended BS EN1729 heights

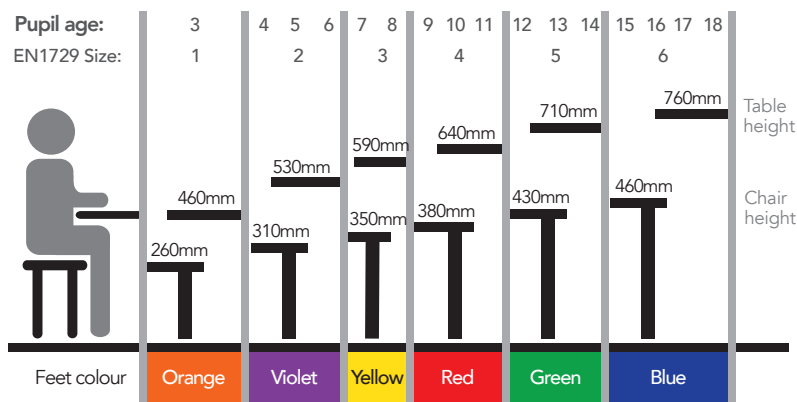

Not sure? Please ask for a sample chair or for a consultant to call & check your heights.

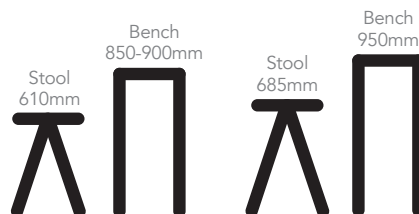

Flex Chair

- Flex is a mobile and flexible solution, allowing you to shift between various seating arrangements and learning activities easily.
- The large work surface is adjustable to its user's body and seating posture
- Large seat shell with lumbar support and flexible body
- Work surface contains silver ions to make it 99.9% Antimicrobial
- Carriage charge will apply on orders of less than 10 chairs



X Base



Star Base



Lecture mode



Group work mode



Discussion mode

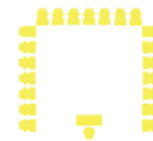

Y100720 - X base with work surface	POA
Y100721 - X base without work surface	POA
Y100722 - Star Base with Work surface	POA
Y100723 - Star base without work surface	POA

Shell Colours



Lava Spice June Avocado Navy Starlight Stone Cosmos

Stax Tables - use indoors or out

- Stacks 15 high within a 2 metre space
- 600 x 600 table, overall width 768mm
- 6kg weight makes them easy to move
- Tested to over 100kg weight load
- Pen groove colour inserts to match the chevron chairs
- Connector available to link the tables together
- Optional tray runners and trays - see pages 48 and 50 for tray colours
- Made from 100% recyclable material
- Transport dolly available



	Height	30+
Y100702	460mm	£53.60
Y100703	530mm	£53.60
Y100704	590mm	£53.60
Y100705	640mm	£53.60
Y100706	710mm	£53.60
Y100707	760mm	£53.60
Y100708	Linking attachment	£14.90
Y100709	Pen Groove Insert	£1.40
Y100710	Tray Runners for A4 Tray (not included)	POA
Y100711	Tray Runners for A3 Tray (not included)	POA



Table Colours



Cool Grey Night Grey

Pen Groove Colours (optional)



Black Blue Night Grey Red Orange Yellow Green Purple Sky Blue

Page Link - see page
 Matching Chevron Chairs
 34

Phone
For Bulk
Prices10 Year
Warranty

A

Segment Table (4 Tables create a 1750mm
Diameter layout - sold individually)

B



PU Edge colours:



Lt Grey Blue Charcoal Red Green

Frame colours



Light Grey Black Metallic Charcoal Silver Grey White Silver

Frame colours: textured silver grey, light grey, metallic charcoal or black. Silver grey will be supplied unless otherwise stated

Top Colours Standard



Red Green Blue Yellow Beech Maple Oak Slate Grey Lt Grey Ailsa Speckle White

Top Colours Premium: +10%



Lilac Tangy Green Orange Flame Purple Canary Soft Blue Soft Lime



Creative Cluster Tables

A. Segment tables

- Truly unique shape offers endless creativity
- Can be used individually as an ergonomic workstation
- Size: 1220mm x 800mm
- 10 Year guarantee
- 25mm top in either premium or standard laminates
- 710mm high as standard, other heights available on request
- Orders of less than 3 tables may carry a carriage charge

YCCTL158

£177.80



B. Diamond tables

New stylish Diamond Tables for classroom flexibility

- Extremely versatile with various shape combinations
- 3 together create a hexagonal shape of 1730mm diameter
- Each individual table is 1440mm x 866mm
- 25mm top in either premium or standard laminates
- 10 year guarantee
- 710mm high as standard other heights are available on request
- Orders of less than 3 tables may carry a carriage charge

Y15601

£261.40

Drywipe
See page 11

Creative Cluster Tables

Phone For Bulk Prices
5 Year Warranty

A. Clover table



- Flexible and dynamic classroom solution
- Ideal for breakout areas
- 18mm top in either premium or standard laminates
- Size: 940 x 890 x H710mm
- 5 Year guarantee
- Other heights available on request
- Castors available POA
- Orders of less than 3 tables may carry a carriage charge

YCCTC126 £157.10



Colour Options See page 6 for colour options



A

B. Pie table



- Mobile, individual workstation
- Triangular shape offers ultimate flexibility
- 5 year guarantee
- Table size: 755 x 660 x h710mm
- Other heights are available on request
- Orders of less than 3 tables may carry a carriage charge

YCCP76 Table £127.50
YCCP76C Mobile Table (1 Castor) £172.50

Colour Options See page 6 for colour options

Bespoke sizes available. Please ask for details.



6 Pie Tables Form 1635mm Diameter Circle

5 Year Warranty

B

C. Triangular table

- Mobile, individual workstation
- Triangular shape offers ultimate flexibility
- 5 year guarantee
- Table size: 1200 x 830 x h710mm
- Other heights are available on request
- Orders of less than 3 tables may carry a carriage charge

Y100313 Table £125.70
Y100329 Mobile Table (1 Castor) £159.60



New Product

C



These tables have slimline 32mm legs allowing more spacing for chairs.
Note: premium colours incur a 10% extra charge on this range.



5 Year
Warranty



Square

Trapezoidal

Arc



Semi Circular

Rectangle

Circular

PU Edge colours:



Lt Grey Blue Charcoal Red Green

Frame colours



Light Grey Black Metallic Charcoal Silver Grey White Silver

Top Colours Standard



Red Green Blue Yellow Beech Maple Oak Slate Grey Lt Grey Ailsa Speckle White

Top Colours Premium: +10%



Lilac Tangy Green Orange Flame Purple Canary Soft Blue Soft Lime Dry Wipe

Calypso Heavy Duty Furniture

Some educational environments demand furniture that will withstand greater wear and tear, these products are manufactured to last and last together with eye-catching style

Heavy duty tables

- 32mm welded tubular frame
- 18mm thick top with a balancing laminate and PU textured edge
- Tamperproof screws
- Choice of laminate colours and Trespa Tops (POA)
- Heavy duty castors can be fitted on 2 legs for mobility at additional cost
- 710mm height as standard, other heights available to order
- Orders of less than 5 tables may carry a delivery charge

Textured PU edge, standard laminate

Y16435	1200 x 600mm Rectangular	£122.80
Y100314	1500 x 750mm Rectangular	£203.30
Y16438	600 x 600mm Square	£104.90
Y16441	1200mm Trapezoidal	£128.80
Y16444	1200mm Semi Circular	£128.80
Y16447	1200mm Circular	£239.00
Y15602A	1490 x 600mm Arc	£282.70
Y16449	Set of Heavy Duty Castors (2)	£61.60

Premium laminates - above price plus 10%



Quantity
rates
available

Contract Classroom Tables



- Excellent range of contract tables in 5 heights
- Choice fully welded (Spiral stacking) or Crushbend (Slide stacking)
- 18mm tops with MDF edge
- Min order 10 tables on this range
- 5 year warranty)

Crushbend tables for ease of stacking

			10+
100315	1200x600x	530h crushbend frame	£69.90
100316	1200x600x	590h crushbend frame	£69.90
100317	1200x600x	640 h crushbend frame	£69.90
100318	1200x600x	710h crushbend frame	£69.90
100319	1200x600x	760h crushbend frame	£69.90



Fully welded tables for strength and stability

			10+
100320	1200x600x	530h fully welded frame	£69.90
100321	1200x600x	590h fully welded frame	£69.90
100322	1200x600x	640h fully welded frame	£69.90
100323	1200x600x	710h fully welded frame	£69.90
100324	1200x600x	760h fully welded frame	£69.90



Top Colours



Beech Grey

Frame Colours



Light Grey Dark Grey Black Silver

Premium primary range



- Modern design and bright colours, ideal for nursery and primary classrooms
- Highest quality fully welded tables with stylish, chunky 32mm tubular legs
- Standard 18mm tops in MDF Bullnose edge with a hard wearing laminate - polished and laquered
- Exceptional strength and style vastly superior to bolt-on and screw on leg systems
- Top choice for Early Years classrooms
- Orders of less than 3 tables may carry a delivery charge
- Primary colours will be supplied with a matching frame unless otherwise stated
- Also available in senior heights



Fully
EN1729
Compliant

5 Year
Warranty

Rectangular

		1-5	6+
Y15773	1100 x 550 x H460mm	£115.00	POA
Y15774P	1100 x 550 x H530mm	£115.00	POA
Y15775	1100 x 550 x H590mm	£115.00	POA
Y15788A	1100 x 550 x H640mm	£115.00	POA

Trapezoidal

		1-5	6+
Y15776P	1100 x 550 x H460mm	£115.00	POA
Y15777	1100 x 550 x H530mm	£115.00	POA
Y15778P	1100 x 550 x H590mm	£115.00	POA
Y100120	1100 x 550 x H640mm	£115.00	POA

Circular

		1-5	6+
Y15779	1100 Diameter x H460mm	£202.70	POA
Y15780P	1100 Diameter x H530mm	£202.70	POA
Y15781	1100 Diameter x H590mm	£202.70	POA
Y100121	1100 Diameter x H640mm	£202.70	POA

Semi Circular

		1-5	6+
Y100173	1100 Semi Circle x H460mm	£115.00	POA
Y100174	1100 Semi Circle x H530mm	£115.00	POA
Y100175	1100 Semi Circle x H590mm	£115.00	POA
Y100176	1100 Semi Circle x H640mm	£115.00	POA
Y16724	1200 Semi Circle x H460mm	£115.00	POA
Y16725	1200 Semi Circle x H530mm	£115.00	POA
Y16726	1200 Semi Circle x H590mm	£115.00	POA
Y15794A	1200 Semi Circle x H640mm	£115.00	POA

- Textured PU edge is available at additional cost

Frame colours



Light Grey Black Metallic Charcoal Silver Grey Red Blue Green Yellow

Top Colours Standard



Red Green Blue Yellow Beech Maple Oak Slate Grey Lt Grey Ailsa Speckle White

Top Colours Premium: +10%



Lilac Tanga Green Orange Flame Purple Canary Soft Blue Soft Lime Gloss White



Fully welded leg frames
- not screwed or bolted



Quantity
rates
available

Page Link - see pages

Adjustable
Tables

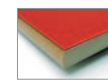

MDF Bullnose Edge



PU Edge (extra cost)

Premium senior range

- Highest quality fully welded tables with stylish, chunky 32mm tubular legs
- Standard 18mm tops in MDF Bullnose edge with a hard wearing laminate - polished and laquered
- Also available with Duraform spray PU edge - POA
- Also available in 16mm Trespa top - which is a solid grade material with a black core and crystal matt surface texture, with smooth and sealed edges. It is particularly suitable for laboratory and food preparation areas. (POA)
- Exceptional strength and style vastly superior to bolt-on and screw on leg systems
- Orders of less than 3 tables may carry a delivery charge
- Colours as shown on page 10
- Also available in primary heights

**5 Year
Warranty**
Square

		1-5	6+
Y15783	600 x 600 x H710mm	£91.30	POA
Y15784A	600 x 600 x H760mm	£91.30	POA

Rectangular

Y15789	1200 x 600 x H710mm	£115.00	POA
Y15790A	1200 x 600 x H760mm	£115.00	POA

Semi Circle

Y15792A	1200 Semi Circle H710mm	£115.00	POA
Y15793	1200 Semi Circle H760mm	£115.00	POA

 See page 10 for
colour options

 Fully welded leg frames
- not screwed or bolted
Whiteboard drywipe tables

Drywipe whiteboard tops are available on all sizes of tables - please contact us for details.

Whiteboard tops (additional cost)

Y100102	£13.90
---------	--------

 Quantity
rates
available

Best
Seller5 Year
Warranty

Classroom Tables - Fully Welded

- These welded frame tables are proven in the education market and have passed FIRA tests for severe educational use
- Precision laser cut frames and non-marking feet
- The welded frame means the tables can only be spiral stacked 4 to 5 high, as opposed to crushbent tables that can be slide stacked. However, the welded frames tend to be stronger
- This fast selling, popular product has a hard wearing laminate top with MDF core
- Choice of rounded MDF edge or square PVC edge
- Orders of less than 5 tables may incur a carriage charge

Fully
EN1729
CompliantExpress
Delivery on
Items
Marked**Outside
summer period

A. 1200 x 600mm rectangular

- Welded Frame

Rounded MDF Edge

		1-29	30+
Y15790	H460mm	£81.30	POA
Y15794	H530mm	£81.30	POA
Y15798	H590mm	£81.30	POA
Y15802W*	H640mm	£81.30	POA
Y15806*	H710mm	£81.30	POA
Y15810*	H760mm	£81.30	POA

Square PVC Edge

		1-29	30+
Y15792	H460mm	£86.40	POA
Y15796	H530mm	£86.40	POA
Y15800	H590mm	£86.40	POA
Y15804	H640mm	£86.40	POA
Y15808	H710mm	£86.40	POA
Y15812	H760mm	£86.40	POA

B. 1100 x 550mm rectangular

- Welded Frame

Rounded MDF Edge

		1-29	30+
Y15822	H460mm	£81.30	POA
Y15826	H530mm	£81.30	POA
Y15830	H590mm	£81.30	POA
Y15834	H640mm	£81.30	POA
Y15838	H710mm	£81.30	POA
Y15842	H760mm	£81.30	POA

Square PVC Edge

		1-29	30+
Y15824	H460mm	£86.40	POA
Y15828	H530mm	£86.40	POA
Y15832	H590mm	£86.40	POA
Y15836	H640mm	£86.40	POA
Y15840	H710mm	£86.40	POA
Y15844	H760mm	£86.40	POA

C. 1100 x 550mm trapezoidal

- Welded Frame
- Also available in 1200 x 600mm POA

Rounded MDF Edge

		1-29	30+
Y15846	H460mm	£96.30	POA
Y15850	H530mm	£96.30	POA
Y15854	H590mm	£96.30	POA
Y15858	H640mm	£96.30	POA
Y15862	H710mm	£96.30	POA
Y15866	H760mm	£96.30	POA

Square PVC Edge

		1-29	30+
Y15848	H460mm	£102.20	POA
Y15852	H530mm	£102.20	POA
Y15856	H590mm	£102.20	POA
Y15860	H640mm	£102.20	POA
Y15864	H710mm	£102.20	POA
Y15868	H760mm	£102.20	POA

Also available in 1200 x 600mm POA

Delivery

All classroom tables and chairs are delivered fully assembled.

Delivery approximately 4 weeks although this will extend over the summer ordering period.

We recommend you do not dispose of your old furniture until you have taken delivery of your new.

Quantity
rates
available

Classroom Tables



A. 600 x 600mm square

- Welded Frame
- Also available in 550 x 550mm POA

Rounded MDF Edge

		1-29	30+
Y15870	H460mm	£69.60	POA
Y15874	H530mm	£69.60	POA
Y15878	H590mm	£69.60	POA
Y15882	H640mm	£69.60	POA
Y15886*	H710mm	£69.60	POA
Y15890*	H760mm	£69.60	POA

Square PVC Edge

		1-29	30+
Y15872	H460mm	£75.10	POA
Y15876	H530mm	£75.10	POA
Y15880	H590mm	£75.10	POA
Y15884	H640mm	£75.10	POA
Y15888	H710mm	£75.10	POA
Y15892	H760mm	£75.10	POA

B. 1000mm diameter circular

- Welded Frame
- Also available in 750, 800 and 1100mm diameters POA

Rounded MDF Edge

		1-29	30+
Y15894	H460mm	£136.40	POA
Y15898	H530mm	£136.40	POA
Y15902	H590mm	£136.40	POA
Y15906	H640mm	£136.40	POA
Y15910	H710mm	£136.40	POA
Y15914	H760mm	£136.40	POA

Square PVC Edge

		1-29	30+
Y15920	H460mm	£118.10	POA
Y15924	H530mm	£118.10	POA
Y15928	H590mm	£118.10	POA
Y15932	H640mm	£118.10	POA
Y15936	H710mm	£118.10	POA
Y15940	H760mm	£118.10	POA

C. 1200 x 600mm diameter semi-circular

- Welded Frame

Rounded MDF Edge

		1-29	30+
Y15918	H460mm	£110.60	POA
Y15922	H530mm	£110.60	POA
Y15926	H590mm	£110.60	POA
Y15930	H640mm	£110.60	POA
Y15934	H710mm	£110.60	POA
Y15938	H760mm	£110.60	POA

Square PVC Edge

		1-29	30+
Y15920	H460mm	£118.10	POA
Y15924	H530mm	£118.10	POA
Y15928	H590mm	£118.10	POA
Y15932	H640mm	£118.10	POA
Y15936	H710mm	£118.10	POA
Y15940	H760mm	£118.10	POA

D. 1100 x 550mm diameter semi-circular

- Welded Frame

Rounded MDF Edge

		1-24	25+
Y15942	H460mm	£110.60	POA
Y15946	H530mm	£110.60	POA
Y15950	H590mm	£110.60	POA
Y15954	H640mm	£110.60	POA
Y15958	H710mm	£110.60	POA
Y15962	H760mm	£110.60	POA

Square PVC Edge

		1-24	25+
Y15944	H460mm	£118.10	POA
Y15948	H530mm	£118.10	POA
Y15952	H590mm	£118.10	POA
Y15956	H640mm	£118.10	POA
Y15960	H710mm	£118.10	POA
Y15964	H760mm	£118.10	POA

Top Colours Standard



* Available on express delivery outside summer holiday period

PVC Edge Colours



Edge Options



Frame colours

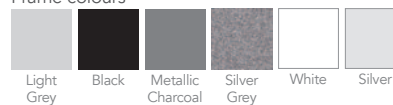

A



B



C



D

Express Delivery on Items Marked*

*Outside summer period

Quantity rates available

Best
Seller

Classroom Tables - Crushbent Frame

- The following range of crushbent framed tables is one of the largest in the UK
- All our products have been proved suitable for severe educational use
- Precision laser cut frames and non-marking feet
- This fast selling table is very popular as it can be easily stacked due to the frame design
- The top has a MDF core with a hard wearing laminate finish
- Choice of rounded MDF or square PVC edge
- Orders of less than 5 tables may incur a carriage charge

A

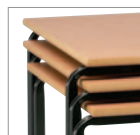

MDF edge

A. 1200 x 600mm rectangular

- Crushbent frame for easier stacking

Rounded MDF Edge		1-29	30+
Y15686	H460mm	£81.30	POA
Y15690	H530mm	£81.30	POA
Y15694	H590mm	£81.30	POA
Y15698	H640mm	£81.30	POA
Y15702	H710mm	£81.30	POA
Y15706	H760mm	£81.30	POA

Square PVC Edge		1-29	30+
Y15688	H460mm	£86.40	POA
Y15692	H530mm	£86.40	POA
Y15696	H590mm	£86.40	POA
Y15700	H640mm	£86.40	POA
Y15704	H710mm	£86.40	POA
Y15708	H760mm	£86.40	POA

5 Year
WarrantyOn All These
ProductsExpress
Delivery on
Items
Marked**Outside
summer period

B

Quantity
rates
availableSlide
Stacking

B. 1100 x 550mm rectangular

- Crushbent for easier stacking

Rounded MDF Edge		1-29	30+
Y15718	H460mm	£81.30	POA
Y15722	H530mm	£81.30	POA
Y15726	H590mm	£81.30	POA
Y15730*	H640mm	£81.30	POA
Y15734*	H710mm	£81.30	POA
Y15738T*	H760mm	£81.30	POA

Square PVC Edge		1-29	30+
Y15720	H460mm	£86.40	POA
Y15724	H530mm	£86.40	POA
Y15728T	H590mm	£86.40	POA
Y15732	H640mm	£86.40	POA
Y15736	H710mm	£86.40	POA
Y15740	H760mm	£86.40	POA

Classroom Tables - Crushbent Frame



A. 1100 x 550mm trapezoidal

- Crushbent for easier stacking

Rounded MDF Edge		1-29	30+
Y15742	H460mm	£96.30	POA
Y15746	H530mm	£96.30	POA
Y15750	H590mm	£96.30	POA
Y15754	H640mm	£96.30	POA
Y15758	H710mm	£96.30	POA
Y15762	H760mm	£96.30	POA

Square PVC Edge		1-29	30+
Y15744	H460mm	£102.20	POA
Y15748	H530mm	£102.20	POA
Y15752	H590mm	£102.20	POA
Y15756	H640mm	£102.20	POA
Y15760	H710mm	£102.20	POA
Y15764	H760mm	£102.20	POA

Also available in 1200 x 600mm POA

B. 600 x 600mm square

- Crushbent for easier stacking

Rounded MDF Edge		1-29	30+
Y15766	H460mm	£69.60	POA
Y15770	H530mm	£69.60	POA
Y15774	H590mm	£69.60	POA
Y15778	H640mm	£69.60	POA
Y15782*	H710mm	£69.60	POA
Y15786*	H760mm	£69.60	POA

Square PVC Edge		1-29	30+
Y15768	H460mm	£75.10	POA
Y15772	H530mm	£75.10	POA
Y15776	H590mm	£75.10	POA
Y15780	H640mm	£75.10	POA
Y15784	H710mm	£75.10	POA
Y15788	H760mm	£75.10	POA



A

Fully EN1729 Compliant

Express Delivery on Items Marked*

*Outside summer period

Gloss White 'Dry Wipe' option at extra cost on standard tables
Order code: Y100102 £12.95



Colour coded frames available - please ask for details



B

Delivery

All classroom tables and chairs are delivered fully assembled.
Delivery approximately 4 weeks although this will extend over the summer ordering period.
We recommend you do not dispose of your old furniture until you have taken delivery of your new.

Top Colours Standard

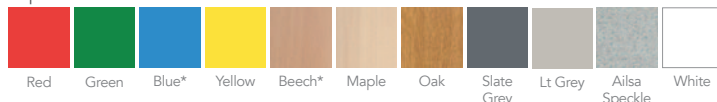

* Available on express delivery outside summer holiday period

PVC Edge Colours



Edge Options



Frame colours

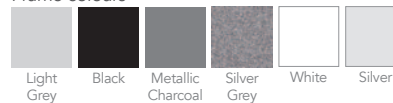

Quantity rates available

5 Year
WarrantyOn All These
ProductsExpress
Delivery on
Items
Marked**Outside
summer periodFully
EN1729
Compliant**Delivery**

All classroom tables and chairs are delivered fully assembled. Delivery approximately 4 weeks although this will extend over the summer ordering period. We recommend you do not dispose of your old furniture until you have taken delivery of your new.

A

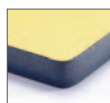

Spray PU Edge

B



C



Also available in
1200 x 600mm POA

D

Quantity
rates
available**PU Edged Tables**

- Impact Resistant - Waterproof Edge Guarantee
- This new technology in table manufacturing is extremely popular as the textured coloured edging is moulded onto the edge of the table, meaning that it cannot be prised or picked away
- Precision laser cut frames and non-marking feet
- Give your classroom an unfading, long lasting, colourful feel with these bright, cheerful and popular classroom tables
- Available with crushbent (stacking) or fully welded frames
- Orders of less than 5 tables may incur a carriage charge

A. 1200 x 600mm rectangular

- Crushbent frame

PU Edged		1-29	30+
Y15496	H460mm	£93.70	POA
Y15498	H530mm	£93.70	POA
Y15500	H590mm	£93.70	POA
Y15502*	H640mm	£93.70	POA
Y15504*	H710mm	£93.70	POA
Y15506*	H760mm	£93.70	POA

B. 1100 x 550mm rectangular

- Crushbent frame

PU Edged		1-29	30+
Y15507	H460mm	£93.70	POA
Y15508	H530mm	£93.70	POA
Y15510	H590mm	£93.70	POA
Y15512*	H640mm	£93.70	POA
Y15514*	H710mm	£93.70	POA
Y15516*	H760mm	£93.70	POA

C. 1100 x 550mm trapezoidal

- Crushbent frame

PU Edged		1-29	30+
Y15530	H460mm	£109.90	POA
Y15532	H530mm	£109.90	POA
Y15534	H590mm	£109.90	POA
Y15536	H640mm	£109.90	POA
Y15538	H710mm	£109.90	POA
Y15540	H760mm	£109.90	POA

D. 600 x 600mm square

- Crushbent frame

PU Edged		1-29	30+
Y15518	H460mm	£82.30	POA
Y15520	H530mm	£82.30	POA
Y15522	H590mm	£82.30	POA
Y15524	H640mm	£82.30	POA
Y15526*	H710mm	£82.30	POA
Y15528*	H760mm	£82.30	POA

A. 1200 x 600mm rectangular

- Welded frame

PU Edged		1-29	30+
Y15554	H460mm	£93.70	POA
Y15556	H530mm	£93.70	POA
Y15558	H590mm	£93.70	POA
Y15560*	H640mm	£93.70	POA
Y15562*	H710mm	£93.70	POA
Y15564*	H760mm	£93.70	POA



5 Year Warranty

On All These Products

Express Delivery on Items Marked*

*Outside summer period

Gloss White 'Dry Wipe' option at extra cost on standard tables

Order code:
Y100102 £12.95

B. 1100 x 550mm rectangular

- Welded frame

PU Edged		1-29	30+
Y15566	H460mm	£93.70	POA
Y15568	H530mm	£93.70	POA
Y15570	H590mm	£93.70	POA
Y15572*	H640mm	£93.70	POA
Y15574*	H710mm	£93.70	POA
Y15576*	H760mm	£93.70	POA

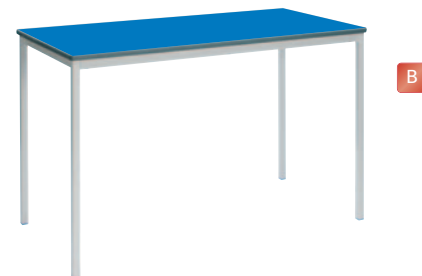

C. 600 x 600mm square

- Welded frame

PU Edged		1-29	30+
Y15578	H460mm	£82.30	POA
Y15580	H530mm	£82.30	POA
Y15582	H590mm	£82.30	POA
Y15584	H640mm	£82.30	POA
Y15586*	H710mm	£82.30	POA
Y15588*	H760mm	£82.30	POA



D. 1100 x 550mm trapezoidal

- Welded frame

PU Edged		1-29	30+
Y15590	H460mm	£109.90	POA
Y15592	H530mm	£109.90	POA
Y15594	H590mm	£109.90	POA
Y15596	H640mm	£109.90	POA
Y15598	H710mm	£109.90	POA
Y15600	H760mm	£109.90	POA



Also available in 1200 x 600mm POA

E. 1000mm diameter circular

- Welded frame

PU Edged		1-29	30+
Y15602	H460mm	£150.20	POA
Y15604A	H530mm	£150.20	POA
Y15606A	H590mm	£150.20	POA
Y15608A	H640mm	£150.20	POA
Y15610A	H710mm	£150.20	POA
Y15612	H760mm	£150.20	POA



Frame colours



Frame colours: textured silver grey, light grey, metallic charcoal or black. Silver grey will be supplied unless otherwise stated

Top Colours Standard

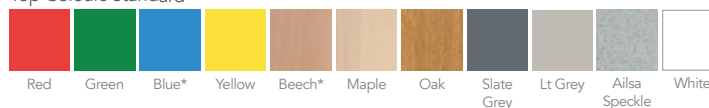

* Available on express delivery outside summer holiday period



PU Edge colours:





5 Year
Warranty

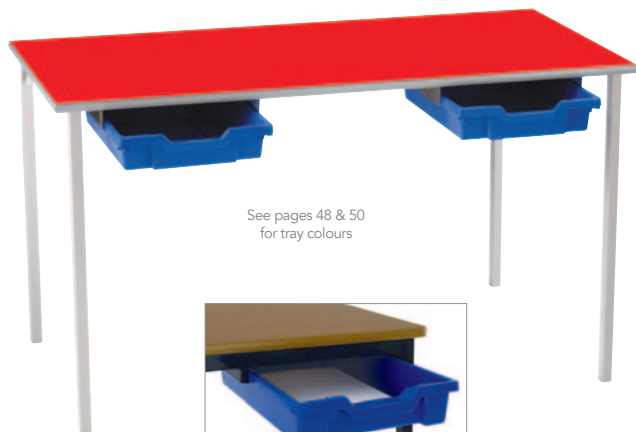

See pages 48 & 50
for tray colours



Tray runner detail

Edge Options

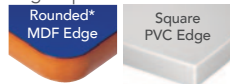

PVC Edge Colours



Frame colours



Top Colours Standard

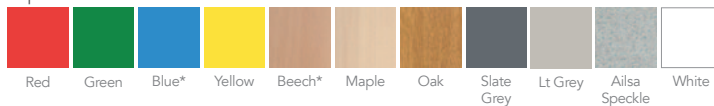

Tray Tables



- Provide some individual storage for the students with these standard classroom tables with special tray packs fitted
- The tables will take all standard trays and some very attractive colour schemes can be worked in the classrooms through use of the trays and table tops
- Please check that pupils will have sufficient leg room under tray tables; you may wish to move up a size
- Orders of less than 5 tables may incur a carriage charge

Quantity
rates
available

A. 1200 x 600mm rectangular

- Welded frame tables

MDF Edge		1-29	30+
Y15614A	H460mm	£126.60	POA
Y15618A	H530mm	£126.60	POA
Y15622A	H590mm	£126.60	POA
Y15626A	H640mm	£126.60	POA
Y15630A	H710mm	£126.60	POA
Y15634A	H760mm	£126.60	POA

Square PVC Edge		1-29	30+
Y15616	H460mm	£133.50	POA
Y15620A	H530mm	£133.50	POA
Y15624A	H590mm	£133.50	POA
Y15628A	H640mm	£133.50	POA
Y15632A	H710mm	£133.50	POA
Y15636A	H760mm	£133.50	POA

Tray tables can also be supplied with a Polyurethane edge instead of PVC- ring for details

5 Year Warranty

A. 1100 x 550mm rectangular

- Welded frame tables

MDF Edge		1-29	30+
Y15638A	H460mm	£126.30	POA
Y15642	H530mm	£126.30	POA
Y15646	H590mm	£126.30	POA
Y15650	H640mm	£126.30	POA
Y15654B	H710mm	£126.30	POA
Y15658A	H760mm	£126.30	POA

Square PVC Edge		1-29	30+
Y15640	H460mm	£133.50	POA
Y15644	H530mm	£133.50	POA
Y15648	H590mm	£133.50	POA
Y15652A	H640mm	£133.50	POA
Y15656A	H710mm	£133.50	POA
Y15660	H760mm	£133.50	POA



B. 600 x 600mm square

- Welded frame tables • Single tray

MDF Edge		1-29	30+
Y15662	H460mm	£88.10	POA
Y15666	H530mm	£88.10	POA
Y15670	H590mm	£88.10	POA
Y15674	H640mm	£88.10	POA
Y15678	H710mm	£88.10	POA
Y15682	H760mm	£88.10	POA

Square PVC Edge		1-29	30+
Y15664	H460mm	£93.80	POA
Y15668	H530mm	£93.80	POA
Y15672	H590mm	£93.80	POA
Y15676	H640mm	£93.80	POA
Y15680	H710mm	£93.80	POA
Y15684	H760mm	£93.80	POA



Tray tables can also be supplied with a Polyurethane edge instead of PVC- ring for details

Please specify:

1. frame colour
2. top colour
3. edge colour (if PVC)
4. tray colour (see pages 48 and 50, stock colours only)

Top Colours Standard

* Available on express delivery outside summer holiday period

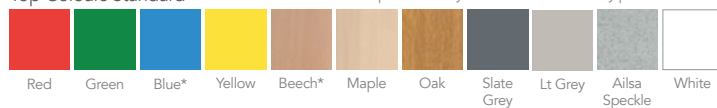

Frame colours

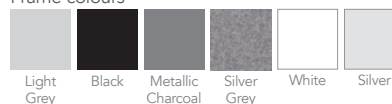

PVC Edge Colours



Edge Options

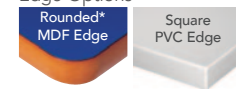

Quantity rates available



Craft Tables

A. Project table

- Sturdy tables for all types of projects
- Light grey laminated tops for durability
- All 800mm high for ease of use
- Frame colours: Grey, Apple Green, Cool Blue, Cyan, Lime, Red & Tangerine

Y15986	W1200 x D1200mm	£517.00
Y15988	W1800 x D1200mm	£669.70
Y15990	W2400 x D1200mm	£799.90

B. Heavy duty craft tables

- Extremely strong H frame table, square heavy duty frame
- Laminate or Trespa tops available
- Heights available are 760, 800, 850, 900, 1000mm
- MDF edge, PU also available POA

Laminate Top

Y15604	1200mm x 600mm	£174.10
Y15605	1200mm x 750mm	£190.90
Y15606	1500mm x 750mm	£287.40

Trespa Top

Y15607	1200mm x 600mm	£348.50
Y15608	1200mm x 750mm	£507.10
Y15609	1500mm x 750mm	£541.30

C. Premium 'H' frame craft table

- Extremely strong H frame table, round heavy duty 45mm frame
- Laminate or Trespa tops available
- Heights available are 760, 800, 850, 900, 1000mm
- MDF edge, PU also available POA

Laminate top

YPREM126LAM	1200mm x 600mm	£248.40
YPREM127LAM	1200mm x 750mm	£267.40
YPREM157LAM	1500mm x 750mm	£315.80

Trespa top

YPREM126TRES	1200mm x 600mm	£482.30
YPREM127TRES	1200mm x 750mm	£651.60
YPREM157TRES	1500mm x 750mm	£699.90



Requires self assembly



A

Express Delivery

5 Year Warranty

Special Sizes Available

B

Quantity rates available

C

10 Year Warranty

Please specify required height

Other colours available. For critical colour matching please ask for a sample

Top Colours - Laminate

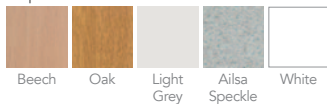

Frame colours

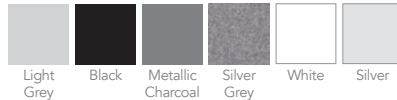

Trespa Speckled Top Colours

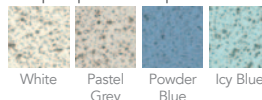

Page Link - see pages

For stools...

38-41



Maker Space Benches



A. Heavy duty steel frame workbench suitable for woodwork and metalwork

- 1200 x 1200mm choice of 810 or 860mm height
- Available with or without cupboards
- Choice of tops (phenolic available for metalworking - POA)
- Choice of frame colours
- Choice of flip over tool well (as illustrated) or solid beech flush tops
- Orders of less than 5 benches may incur a carriage charge

Solid Beech Top

155011	Workbench with Cupboard	POA
155012	Workbench without Cupboard	POA

MDF Top with Solid Beech Edgings

155013	Workbench with Cupboard	POA
155014	Workbench without Cupboard	POA

Vice for Benches

155015	175mm Plain Screw Woodwork Vice	POA
--------	---------------------------------	-----

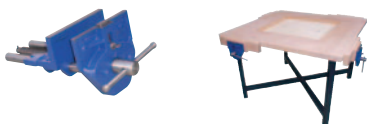

Frame Colours



Red Green Blue Yellow Black Anthracite Grey Light Grey

B. Multipurpose technology bench

- 1200 x 1200 x 860mm height (other heights available)
- Choice of frame colours
- Choice of tops
- Orders of less than 5 benches may incur a carriage charge

155018	Bench with MDF Top	POA
155019	Bench with Zinctec Metal Top	POA
155020	Heavy Duty Castors for Bench set of 4	POA



Quantity rates available

Bespoke Work Benches And Tables Available- Please Ask For Details
Quantity Discounts Available



Can be accessed from either side



Portholes can be added on request for additional cost



Removable Handle - Top or Side Operated



A full range of other sizes are available

Access height adjustable table



- Modern silver frame, strong construction
- Infinitely adjustable by handle between 512 and 805mm
- Suitable for wheelchair use
- MDF or PU edge (POA)
- Available with Trespa tops for science or food tech use - poa

1200 x 600mm Double Desk

Y15802 Access Desk - MDF Edge **£451.10**

700 x 600mm Single Desk

Y15803 Access Desk - MDF Edge **£401.40**

Heavy Duty Top 25mm

Y16727 Additional Cost **£23.40**

Quantity rates available

Page Link - see page

For more height adjustable tables

127



Top Colours Standard



Red Green Blue Yellow Beech Maple Oak Lt Grey Ailsa Speckle White

PU Edge colours. Additional cost



Lt Grey Blue Charcoal Red Green

Edge Options

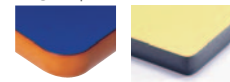

MDF Edge

PU Edge (addnl cost POA)

Straight Top Locker Desks



- These traditional desks are still popular throughout education and with good reason as they provide a sturdy, quality, long-lasting solution
- The desk frame is solid beech with mortice and tenon joints, glued and screwed for extra strength
- The desk lid is a beech melamine MDF top providing a matching finish
- The straight top locker desks have a pen groove on the back edge and are available as single or double desks
- The width between the legs is suitable for most chair types, internal width is shown below
- Orders of less than 6 tables may carry a delivery charge



A. Double locker desks

	h x w x d mm	Internal width	6-19	20+
Y16406	650 x 1100 x 456	1004mm	£254.60	POA
Y16408	700 x 1100 x 456	1004mm	£254.60	POA
Y16410	750 x 1100 x 456	1004mm	£254.60	POA

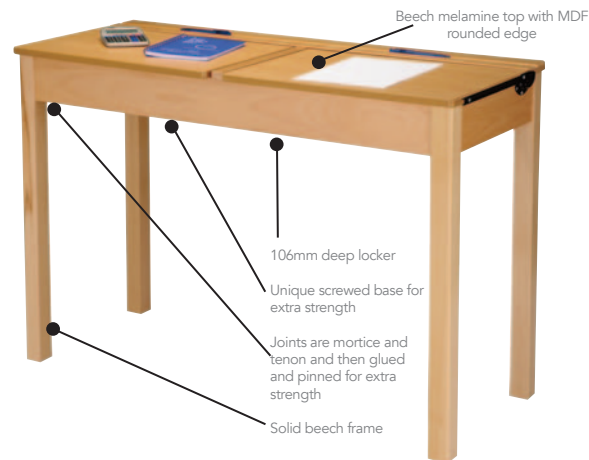

A

Did you know?

- Beech melamine MDF tops increase the lifespan by three times compared to solid beech tops
- Coloured tops are also available to order. Please call for details

B. Single locker desks

	Internal h x w x d mm	width	6-19	20+
Y16400	650 x 600 x 456	500mm	£164.40	POA
Y16402	700 x 600 x 456	500mm	£164.40	POA
Y16404	750 x 600 x 456	500mm	£164.40	POA



B

Also available...
...sloping top and stepped locker desks.
Please ask for details

Quantity rates available

Express
Delivery7 Year
Warranty

A

New Lower
Cost RangeExpress
Delivery5 Year
Warranty

B



Frame Options



Graphite Silver

Wood Finish Options



Beech Oak White

C

Quantity
rates
availablePlease specify:
1. frame colour
2. top colour
3. edge colour (if PVC or PU)

Top Colours Standard



Red Green Blue* Yellow Beech* Maple Oak Light Grey* Ailsa Speckle White Lilac Orange Flame* Purple Soft Lime Tanga Green

Frame colours



Black Metallic Charcoal Silver Grey*



Teacher's Desks

A. Single pedestal desk

- This popular range of teacher's desks is available in a choice of wood finishes
- Drawers are mounted with metal runners and are fully lockable
- 3 drawer as standard, a 2 drawer pedestal including a filing drawer is also available at the same cost. Pedestals can be fitted on either side, please specify
- 5 year guarantee
- Quantity discounts available

Y100325	1200 x 800 x 725mm High	£295.00
Y100326	1600 x 800 x 725mm High	£335.00

Please specify melamine wood finish as shown below

Page Link - see page

For
teacher's
chairs

B. Double pedestal desk

- The double pedestal desk is a long-standing favourite with teachers
- Drawers are mounted with metal runners and are lockable
- 5 year guarantee
- Quantity discounts available

Y100327	1600 x 800 x 725mm High	£478.00
---------	-------------------------	---------

Please specify melamine wood finish as shown below

Page Link - see page

For
teacher's
cupboards

C. Teacher's desk

- Teacher's desk to match student desks on pages 6-15
- MDF edge (PVC and PU edges available at extra cost)
- Fully welded frame, delivered assembled
- 720mm high as standard, also available in 710 and 760mm

Y100201	2 Drawer Teacher's Desk	£397.30
Y100202	3 Drawer Teacher's Desk	£458.80

Please specify melamine wood finish as shown below

Teacher's Desks



A. Alpine panel leg teacher's desk

- 25mm thick MFC top with 3mm abs edging
- Choice of 9 colours
- Locking drawers
- Complete with 2 cable ports
- Cantilever legs also available
- 5 year warranty
- Matches Alpine furniture on page 308

W x D x H mm

Y100100	Single Pedestal Desk	1200 x 800 x 725	£469.10
Y100101	Double Pedestal Desk	1600 x 800 x 725	£713.30



Express Delivery

5 Year Warranty

A

Alpine Tables MFC Finishes

Group 1 Colours

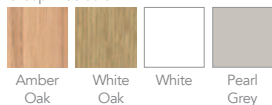

Group 2 Colours +10%

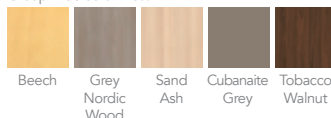

Wood & colour finishes may not be representative of actual colours - please ask for a sample

B. Comet teacher desk and mobile pedestal

- W1600 x D800 x H730mm twin cantilever desk
- Flatpack for easy self-assembly
- 2 drawer mobile pedestal (595mm high)
- Lockable and supplied with 2 keys
- 5 year guarantee

Y100235	£329.00
---------	---------

Wood Finish Options

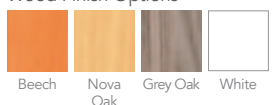

Frame Colours

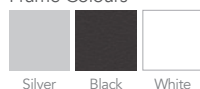

5 Year Warranty

B

Page Link - see page
For teacher's cabinets → 403



Page Link - see page
More teachers' desks... → 308-309

C. Wilmington compact desk

- Compact teacher's desk with lockable 3 drawer pedestal
- 1200 x 600mm
- 12 finishes are available
- Complete with 2 cable ports
- 5 year warranty

Y100103	Wilmington Compact Desk	£435.60
---------	-------------------------	---------

Wood Finish Options



5 Year Warranty

C

Quantity rates available

Best Seller

Express Delivery

5 Year Warranty

Try before you buy!
Sample chairs available

Options for all Poly Chairs

Wire Link
Y16339 POAWriting Tablet
Y16340 POA
(460mm high only)Upholstered Seat Pad
Y16344 POAUpholstered Seat & Back
Y16346 **£19.70**

5 Year Warranty



Quantity rates available

Top colours



Hi Red Hi Green Hi Blue Yellow Charcoal Blue

For critical colour matching please ask for a sample

Frame colours



Black Dark Grey Light Grey Smooth Silver Textured Black Textured Dk Grey

Poly Chairs

A. The poly chair



- The traditional poly chair has been proven through years of use in schools and colleges
- Complies to new EN1729 height requirements
- Meets BS4875 level 5 for strength and stability
- Stacks 20 high

	Seat Height	Overall Width	1-29	30+
Y15420	260mm	365mm	£22.70	POA
Y15424	310mm	395mm	£23.30	POA
Y15428	350mm	445mm	£23.90	POA
Y15432	380mm	465mm	£24.80	POA
Y15436	430mm	475mm	£25.80	POA
Y15440	460mm	495mm	£26.70	POA

Orders of less than 10 chairs may carry a carriage charge

B. Poly skid base chairs



- The same structure as the poly chair shown above, these chairs stack as well as the four legged chair and are extremely popular in classrooms due to the extra stability
- Often specified by local Councils and in Design and Build projects
- Primary sizes available
- Many of the options above can also be used on this chair
- Chair width is 600mm, wider than a 4 leg chair, please ensure that you have room between table legs

	Seat Height	Overall Width	5-29	30+
Y15444	430mm	600mm	£29.70	POA
Y15448	460mm	600mm	£30.50	POA

Orders of less than 10 chairs may carry a carriage charge

A. Standfast poly chair



- Comfortable and durable traditional poly chair
- Space saving design-narrower than most poly chairs
- Ideal for school hall use where space must be maximised
- Stackable 8 high
- Options- seat and back pads, writing tablets, skid frames version, IT version, please contact us for details
- 10 year warranty, complies with EN1729
- Orders of less than 10 chairs may incur a carriage charge

Code	Seat height	Overall width	1-29	30+
Y100150	260	365	£18.70	POA
Y100152	310	365	£19.20	POA
Y100154	350	365	£19.90	POA
Y100156	380	400	£20.90	POA
Y100158	430	450	£23.30	POA
Y100160	460	450	£23.30	POA

Shell colours



Frame



Please ask for details of other options - Skid Base, Tablet, Upholstered and linking options.



10 Year Warranty

Narrow Width

A

B. Chiltern chair



The Chiltern range represents excellent value for money, a strong classroom chair at a very reasonable price.

- High quality powder coated steel frame
- Stacks 10 high
- 6 year warranty
- Meets EN1729 part 2
- Orders of less than 10 chairs may carry a carriage charge

	Seat Height	Overall Width	1-29	30+
Y100104	260mm	425mm	£18.70	POA
Y100105	310mm	425mm	£19.60	POA
Y100106	350mm	425mm	£20.30	POA
Y100107	380mm	518mm	£21.60	POA
Y100108	430mm	518mm	£25.70	POA
Y100109	460mm	518mm	£25.90	POA
Y100232†	Extra cost for Anti-microbial protection		£2.70	POA

Recycled, Black and Blue in 430mm, Black only on 460mm

	Seat Height	Overall Width	1-29	30+
Y100308	430mm	518mm	£21.70	POA
Y100309	460mm	518mm	£21.70	POA

Shell colours

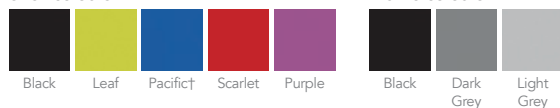

Frame colours



Antimicrobial

24 Hour Protection

†Available on Blue Only



Phone For Bulk Prices

6 Year Warranty

B

10 Year
WarrantyExpress
Delivery
(Blue Only)

Classic Poly Chair

A. Classic poly chair

The original school polypropylene chair design, still one of the most popular.

Tested to EN1729 for strength and stability in addition to general dimensions and seat heights.

- Stacks 6 high
- 10 year warranty

Options available (at extra cost):

- Flame retardancy
- Chair linking (430mm height only)
- Seat upholstery
- Back upholstery
- Writing tablets (chairs with writing tablets will only stack 2 high). Only available on 460mm, 430mm & 380mm high
- Orders of less than 10 chairs may carry a carriage charge

	Seat Height	Overall Width	1-29	30+
Y16701	320mm	350mm	£20.60	POA
Y16702	350mm	360mm	£23.50	POA
Y16703	380mm	400mm	£24.90	POA
Y16704	430mm	470mm	£24.90	POA
Y16705	460mm	470mm	£25.50	POA



A

Optional Linking
MechanismOptional Writing
Tablet

Frame Colours



Black Grey Silver

Shell Colours



Red Orange Yellow Lime Green Jade Emerald



Blue Sapphire Brown Charcoal Black Purple

For critical colour
matching please
ask for a sample

B

Quantity
rates
available



B. Chair trolley

- Fits most chairs
- Nylon covered wheels



Y16389A	Chair Trolley	£88.00
---------	---------------	--------

A. Forum chair



- Ergonomically designed for correct posture
- Fully Compliant to BS EN1729
- Smooth lines give a clean shape which is both comfortable and supportive
- Extra strong under carriage with no separate under-frame
- Outstanding 15 Year Guarantee
- Available in heights for all age ranges
- Can be stacked up to 10 high
- Silver grey frame colour as standard
- Orders of less than 6 chairs may incur a carriage charge

Tamper Free Design

Fully EN1729 Compliant

15 Year Warranty

Express Delivery

Quantity rates available

Express Delivery on all products except upholstery

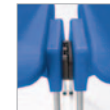

Stacks 10 high

Upholstered version available

Linking Option POA

	Seat Height	Overall Width	6-29	30+
Y15617	260mm	370mm	£25.60	POA*
Y15618	310mm	370mm	£26.60	POA*
Y15619	350mm	426mm	£32.60	POA*
Y15620	380mm	426mm	£33.30	POA*
Y15621	430mm	474mm	£42.50	POA*
Y15622	460mm	474mm	£43.20	POA*
Y15624	Linking Device**		£7.40	POA*
Y15625	Upholstered Factory** Fitted Seat Pad			POA

* Please ring for best prices

** Only available on 430 & 460mm high chairs

Shell options

For critical colour matching please ask for a sample



Fabric options for seat pad

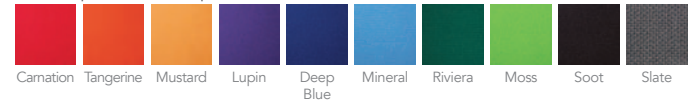

B. Atlas skid base chair



- An extremely strong yet compact chair
- Ideal for use in school halls or where space is limited
- Linking attachment available
- Orders of less than 10 chairs may incur a carriage charge

Code	Seat Height	Overall Width	4-29	30+
Y16500	260mm	370mm	£31.90	POA
Y16501	310mm	370mm	£32.60	POA
Y16502	350mm	410mm	£33.40	POA
Y16503	380mm	460mm	£33.90	POA
Y16504	430mm	460mm	£34.10	POA
Y16505	460mm	460mm	£34.90	POA
Y16506	Dolly & Handle for Atlas Skid Base Chair		£303.00	POA
Y16507	Linking Attachment			POA



10 Year Warranty

Stacks up to 25 high using dolly

For critical colour matching please ask for a sample



Frame Options



* Colours depicted are only a guide. For an exact swatch sample or alternative colour please call us to discuss your requirements.
* Black seat shell only available in sizes 380, 430 & 460mm.

6 Year
Warranty

Strong Riveted Fixings



A. The Profile chair

- Modern contoured style
- Complies with EN1729 Parts 1 & 2
- Can be stacked 8 high with great stability
- Orders of less than 10 chairs may carry a carriage charge



Code	Details	Seat Height	Width	4-29	30+
Y100186	4 Legged Chair	430	480	£47.70	POA
Y100187	4 Legged Chair	460	480	£48.30	POA
Y100188	Skid Base Chair	430	530	£54.50	POA
Y100189	Skid Base Chair	460	530	£57.40	POA
Y100190	Cantilever Chair	430	530	£67.90	POA
Y100191	Cantilever Chair	460	530	£68.60	POA
Y100192	Optional Seat Pad			£26.60	POA

Page Link - see page

For the
IT Swivel
version...

166

Quantity
rates
available

Mobile chairs - please ask for details

B. The contour poly chair

- Modern contoured style
- Complies with EN1729 Parts 1 & 2
- Can be stacked 8 high with great stability
- Orders of less than 10 chairs may carry a carriage charge



Code	Seat Height	Overall Width	1-29	30+
Y16720	350mm	440mm	£35.10	POA
Y16721	380mm	440mm	£35.80	POA
Y16722	430mm	500mm	£36.50	POA
Y16723	460mm	500mm	£36.90	POA

6 Year
Warranty

Shell colours:



Flame (FL) Lime (LM) Mulberry (MB) Ocean (ON) Onyx (OX) Red (RD) Sky (SK) Slate (ST) White (WH) Yellow (YW)

Frame colours



Black Charcoal Chrome Silver Dark Grey Light Grey Textured Silver

Flow classroom chair



- Modern design
- Ergonomic style
- Angled legs to discourage tilting
- Waterfall seat front
- Light grey frame
- Stacks 6 high
- Chair linking available POA
- Orders of less than 10 chairs may carry a carriage charge

	Seat Height	Overall Width	1-29	30+
Y16540	260mm	360mm	£41.80	POA
Y16541	310mm	370mm	£42.40	POA
Y16542	350mm	410mm	£44.30	POA
Y16543	380mm	410mm	£44.90	POA
Y16544†	430mm	460mm	£46.20	POA
Y16545†	460mm	460mm	£47.50	POA
Y100123	Skid Base	460mm	£50.70	POA

“This chair clearly considers all ergonomic factors for a modern classroom chair. In addition, the chair’s aesthetics are design led whilst maintaining exceptional value for money. FIRA have recommended that the chair is put forward for the schools certification scheme - for products going beyond the standard BS EN1729.”

- Levent Caglar, Senior Ergonomist & Head of Ergonomics Unit, FIRA.



15 Year Warranty

Express Delivery



Quantity rates available

Meet the family



Skid Base



High (see page 41)



Swivel (see page 166)

5 Year Warranty On Swivel Chair

For critical colour matching please ask for a sample

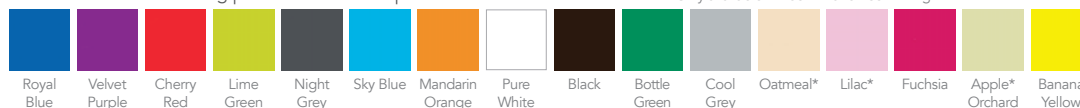

* Only available in 430mm and 460mm high

Frame colours



Mono Posture Chair

- The UK's most popular classroom chair.
- Ergonomically designed to promote good posture and provide exceptional comfort.
- FIRA certified meeting BS EN1729 Parts 1 & 2 for dimensions, strength and stability.
- Black chairs -100% recycled.
- All other colours - 50% recycled.



	Approx. Seat Height	Size	Overall Width	1-29	30+
Y16514	260mm	1	360mm	£22.90	POA
Y16515	310mm	2	360mm	£23.65	POA
Y16516	350mm	3	430mm	£24.50	POA
Y16517	380mm	4	430mm	£25.20	POA
Y16518	430mm	5	480mm	£28.30	POA
Y16519	460mm	6	480mm	£29.95	POA
Y16520	Seat Pad				POA
Y16521	Linking Device (430 & 460mm Heights)				£12.90

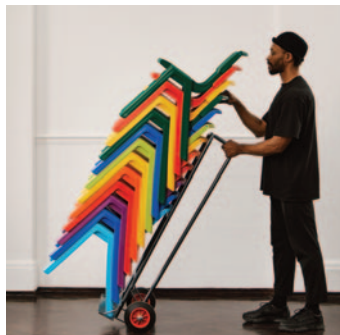

Poly colour options

Rose Blossom

Grape Crush

Poppy Red

Purple Haze

Light Sand

Tangerine Fizz

Sun Yellow

Misty Brown

Hazy Jade

Lime Zest

Forest Green

Moss Green

Powder Blue

Aqua Blue

Ink Blue

Nordic Blue

Ash Grey

Iron Grey

Slate Grey

Jet Black

Available sizes

One-piece / Stool

One-piece / High chair

Task chair

Task stool

1 2-4 5-6

All

All

All

All

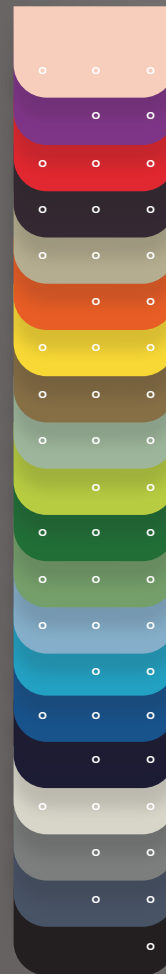

Posture Chairs



A. Mono posture IT chair

- Perfect ergonomics with unique waterfall seat edge and lower back lumbar design
- Flame retardant to CRIB 5, compliant to BS5852 2006
- Available in 15 colours
- Size: H395-485 x W415 x D450 x overall H760-850mm
- 5 year warranty
- Orders of less than 10 chairs may carry a carriage charge

		1-29	30+
Y32011	Mono Posture with Glides	£85.80	POA
Y32011C	Mono Posture with Castors	£85.80	POA



Glides Castors



5 Year Warranty

* Colours available as Mono Posture chair opposite

Page Link - see pages
For more IT chairs 166-173



Quantity rates available

B. Roma chair

Roma is a contemporary and comfortable stacking chair. Stacking up to 38 chairs on a dolly, Roma really comes into its own when seating is required on a large scale. They are a popular choice for halls, meeting areas and classrooms.

- 15 year warranty
- Orders of less than 10 chairs may carry a carriage charge

		1-29	30+
Y16716	Roma Chair	£99.90	POA
Y16728	Transport Dolly	£283.80	POA
Y100310	Optional Linking Plastic Glides	£9.90	POA

Express Delivery

*Express delivery on indicated colours 10-15 days

15 Year Warranty



Linking Plastic Glides



Upholstered seat pad



Removable left or right handed tablet arm

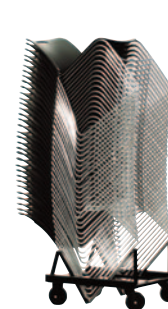

Stacks up to 38 high



21 Year
Warranty

A



Stacks 21 High

B

Ideal dining and hall chair
- 30 fit on a trolleyQuantity
rates
available10 Year
WarrantyNew
Product

C



Posture Chairs

A. Chevron chair



- One Piece Polypropylene Chair
- Streamline Design for exceptional ergonomics, comfort and a modern look
- Stronger and Lightweight - glass filled polypropylene ensures greater strength and durability, yet lighter weight
- Space Saving Stack-ability - the chair stacks easily for efficient storage, up to 21 chairs within a 2 metre height
- Slim line curved legs for pleasing aesthetics
- Sustainable Materials - uses less materials than any other chair in its class. Made from fully recyclable materials
- Stacks 21 high
- 11 Colours available
- Orders of less than 30 chairs may carry a carriage charge

	Seat Height	Overall Width	1-29	30+
Y100142	260mm	400mm	£18.90	POA
Y100143	310mm	400mm	£19.70	POA
Y100144	350mm	460mm	£21.60	POA
Y100145	380mm	460mm	£24.20	POA
Y16717	430mm	500mm	£28.20	POA
Y16718	460mm	500mm	£29.50	POA
Y100116	Linking Device		£6.60	POA

B. Trolley to take 30 chevron chairs

- Supplied flat packed for easy assembly
- Complete with ratchet strap
- Suitable for chair heights 350, 380, 430 and 460mm

Y100118	each	£159.00
---------	------	---------

C. Chevron stool & high stool



- 100% Recyclable one piece high chair
- Optional bag hook available
- Stool stacks 16 high within 2 meters
- High chair stacks 12 high within 2 meters
- Anti-tilt frame
- Easy to clean
- Weight limit 125kg (275lbs)
- EN1729 compliant parts 1 and 2 (pending)
- Stocked in Night Grey, other colours made to order

Chevron stool

	Seat Height	Overall Width	1-29	30+
Y 100332	610mm	495	£55.60	POA
Y 100331	685mm	495	£57.00	POA

Chevron high chair

Y100334	610mm	495	£50.70	POA
Y100333	685mm	495	£59.90	POA

For critical colour matching please ask for a sample

Royal
Blue

Sky Blue

Lime
GreenBanana
YellowMandarin
OrangeCherry
RedVelvet
PurpleDark
GreyBottle
GreenPure
WhiteBlack
460 Only

Posture Chairs

A. Positive Posture chairs

Best Seller
20 Year Warranty

- The Titan chair is the first one-piece polypropylene chair that has attained EN1729 certification
- The benefit of one-piece polypropylene chairs is well documented in terms of their longevity (20 year guarantee), comfort and safety in the classroom
- With no screws or rivets, no sharp edges and no metal work to rust, the Posture chair offers all the benefits of a one-piece chair with the added EN1729 certification
- The Titan chair complies fully with EN1729 height regulations, but is also one of the few chairs that meets its posture and sitting position requirements
- Can be stacked 15 high & offers excellent value for money
- Orders of less than 30 chairs may carry a carriage charge

	Seat Height	Width	5-29	30+
Y15400	310mm	360mm	£22.20	POA
Y15402	350mm	430mm	£23.10	POA
Y15404	380mm	430mm	£23.70	POA
Y15406	430mm	480mm	£28.10	POA
Y15408	460mm	480mm	£29.95	POA
Y15409	Linking Attachment		each	£2.95

†Sizes 310, 350 and 380 are not available in Burgundy, Grey, Black or Midnight Blue



- Hand hold
- Integral lumbar support
- Flat seat and waterfall front removes pressure points
- Leg rake to prevent tilting

A

For critical colour matching please ask for a sample

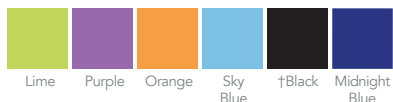

Linking clip

Stackable 15 high



Orders for less than 10 chairs may carry a carriage charge

B. Ergo chair



25 Year Warranty

- Latest ergonomic design
- Heavy duty - tested for 158kg user weight
- Fully recyclable
- Unique top edge gives a hand grip for safe lifting
- Advanced pelvic and lower spine support
- Stacks efficiently - 10 chairs take only 1500mm

	Seat Height	1-29	30+
Y100225	430	£25.80	POA
Y100226	460	£26.60	POA

For critical colour matching please ask for a sample

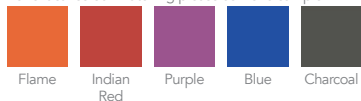

Quantity rates available

B

10 Year
WarrantyPrices
Held for
2024Prices
Held for
2024Quantity
rates
availableFor seat dimensions
see pages 284-287

A. Pennine posture chair

- Innovative design for perfect postural support
- Pelvic support back relieves pressure
- 10 year warranty
- Orders of less than 10 chairs may carry a carriage charge

	Seat Height	Overall Width	1-29	30+
Y100110	260mm	360mm	£27.20	POA
Y100111	310mm	360mm	£27.90	POA
Y100112	350mm	410mm	£29.90	POA
Y100113	380mm	410mm	£30.50	POA
Y100114	430mm	470mm	£34.10	POA
Y100115	460mm	470mm	£34.70	POA

Frame colours



Black Dark Grey Light Grey

Shell colours



Leaf Mocha Pacific Scarlet Purple Ivory Slate Ebony

Page Link - see pages

For
Upholstered
Chairs

270



B. Pennine plus chair

- Ideal for secondary and further education
- Robust, stylish chair with rounded back
- Pelvic support back relieves pressure
- Orders of less than 10 chairs may carry a carriage charge

Code	Seat Height	Overall Width	1-29	30+
Y100184	430	470	£34.10	POA
Y100185	460	470	£34.70	POA

Frame colours



Black Dark Grey Light Grey Ivory

Shell colours



Flame Indian Red Lavender Olive Peat Sand Sea Mist Sunshine Terracotta

A. Folding event chairs - linking

- Integral linking feature, complies with fire regulations for performances, a much stronger solution than plastic linking clips
- These light weight folding chairs are extremely durable with a metal frame and the curved, supportive back provides additional comfort
- These chairs quickly fold and can be stored on the standard storage trolleys
- Weighs only 3.5kg
- Designed for occasional use, weight limit 100kg
- 12 months warranty
- Packed in 8's

Phone For Bulk Prices
Best Seller

A

Integral Linking



		8-96	97+
Y15483	Blue Linking Chair	£16.90	POA
Y15484	Burgundy Linking Chair	£16.90	POA
Y15485	Grey Linking Chair	£16.90	POA

B. Standard exam chairs

- Lightweight, folding exam chairs
- Tough, compact, versatile, suitable for indoor and outdoor event use
- The chairs fold flat in seconds and can be stored on trolleys with up to 60 chairs
- Fire retardant chairs (POA) and linking clips available
- Weight limit 100kg, designed for occasional use
- 1 year warranty
- Packed in 8's

Express Delivery
Best Seller

B



		8-48	49+
Y16523	Blue Exam Chair	£16.30	POA
Y16524	Burgundy Exam Chair	£16.30	POA
Y16525	Grey Exam Chair	£16.30	POA

Chair Trolleys



C. 40 chair flat trolley

- Suitable for most types of folding chairs
- 40 chair storage trolley with heavy duty castors
- L1780 x W780 x H1340mm
- Will fit through a standard doorway
- 5m ratchet strap included
- Requires simple self assembly

C



Y1548640	£149.90
----------	---------

D. 60 chair trolley

- 60 chair trolley with heavy duty castors and black frame
- L1750mm x W790mm x H1100mm (fully loaded)
- Will fit through normal doorway
- Requires simple self assembly

D



Larger trolleys also available - please enquire

Y16527	£307.90
--------	---------

A

Express
DeliveryRing for
details

A. Graduate cantilever stool

- Waterfall seat front
- Scuff resistant & anti-tilt feet buffers
- Complies to EN1729
- 50 x 30mm oval frame
- Stacking 6 high
- Anthracite fully welded grey frame
- Height 610mm
- 1 year warranty

		1-29	30+
Y100195	Natural Wood Seat	£47.20	POA

Page Link - see page

Craft
tables

20

10 Year
Warranty

B



B. Olympic stool



- New innovative design
- Aerated, angled seat
- Heavy Duty frame with stable design
- Long lasting Duragrip feet
- Choose from 8 bright, modern seat colours and 3 frame colours
- Complies with EN1729
- 10 year warranty
- Please contact us for advice if these stools are to be used on abrasive safety flooring

	Seat Height	1-29	30+
Y19100	430mm	£42.90	POA
Y19101	525mm	£42.90	POA
Y19102	610mm	£42.90	POA
Y19103	685mm	£42.90	POA
Y19104	760mm	£42.90	POA
Y155027	Tilting Steel Feet Set of 4	£6.30	POA
Y100330	Optional Bag Hook	£6.40	POA

Frame Colours



Black Grey Silver

Shell Colours

For critical colour matching please ask for a sample



Red Orange Green Blue Pink Charcoal Black Purple

A. Solid beech stools

- These traditional stools are still extremely popular, especially in laboratories and art rooms
- Manufactured from solid beech, these stools will provide a solution that will last for many years
- Choose from 4 heights
- Orders of under 8 stools may incur a carriage charge

	Seat Height	5-29	30+
Y15000	510mm	£72.90	POA
Y15002	560mm	£72.90	POA
Y15004	610mm	£72.90	POA
Y15006	685mm	£72.90	POA

Fully EN1729 Compliant



Express Delivery
5 Year Warranty
On All These Products

A

B. Student lipped stool



- This stool is without a doubt the UK's best selling and most popular stool
- These stools are specified for major projects countrywide because of their unique seat shape and integral lumbar support
- The stools have a robust frame, unique lumbar support and a well positioned footrest
- The stools come in 10 shell colours with an option for steel feet and have a 5 year guarantee
- Please contact us for advice if these stools are to be used on abrasive safety flooring as steel feet may be necessary

	Seat Height	5-29	30+
Y15007A	395mm	£41.30	POA
Y15008	445mm	£41.30	POA
Y15010	560mm	£41.30	POA
Y15012*	610mm	£41.30	POA
Y15014*	685mm	£41.30	POA
Y15016	Steel Feet - Set of 4	£5.00	POA



B

C. Skid base stool

- Extremely strong and stable
- Same popular seat design
- Plastic glides essential for abrasive floors

	Seat Height	5-29	30+
Y16729	395mm	£47.80	POA
Y16730	445mm	£47.80	POA
Y16731	560mm	£47.80	POA
Y15015A*	610mm	£47.80	POA
Y15017A*	685mm	£47.80	POA
Y100301	Plastic Glides	£3.20	POA

Phone For Bulk Prices
Express Delivery on Items Marked*
Best Seller



C

Seat Colours for Stools For critical colour matching please ask for a sample

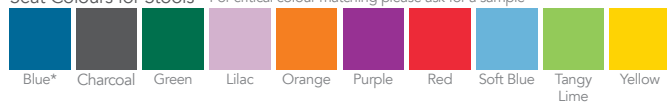

Frame colours

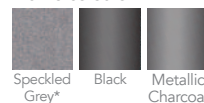

Phone
For Bulk
Prices

A

FIRE
RETARDANT
Option In Blue
& Charcoal



Rectangular Stools



- This highly popular stool has a 19mm sturdy tubular frame with a poly seat. Available in 4 heights
- Black, grey, charcoal or silver frame. Black will be supplied unless otherwise indicated
- Steel feet necessary for use on abrasive safety flooring
- Fire retardant option (blue and charcoal)
- Please contact us for advice if these stools are to be used on abrasive safety flooring
- Orders of less than 6 stools may incur a carriage charge

	Seat Height	5-29	30+
Y16712	430mm	£29.90	POA*
Y16713	525mm	£29.90	POA*
Y16714	610mm	£29.90	POA*
Y16715	685mm	£29.90	POA*
Y100227	Extra cost for Fire Retardancy	£2.25	POA*
Y155027	Tilting steel feet set of 4	£6.30	POA*

*Please ring for best price

Page Link - see page

Craft
tables

20



Shell Colours For critical colour matching please ask for a sample

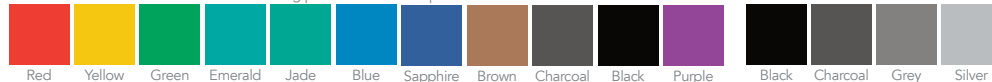

Frame Colours

10 Year
Warranty

B



B. Pennine posture stool & high chair



- Ergonomic design promotes good posture
- EN1729 compliant
- Optional saddle feet for use on abrasive floors

Stool

	Stool Height	1-29	30+
Y100179	430mm	£39.90	POA
Y100180	525mm	£39.90	POA
Y100181	610mm	£39.90	POA
Y100182	685mm	£39.90	POA
Y155026	Optional Saddle Feet Set	£8.30	n/a

High Chair

	Stool Height	1-29	30+
Y100217	525mm	£42.95	POA
Y100218	610mm	£42.95	POA
Y100219	685mm	£42.95	POA

Please contact us for advice if the stools are to be used on abrasive safety flooring

Shell colours



Frame colours

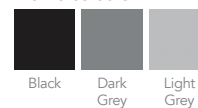

A. Mono stools & high chairs - steel frame

- Available in 3 heights
- Integrated bag hook
- Ergonomically designed to promote good posture and provide exceptional comfort
- Certified to FIRA to meet BS EN1729 Parts 1 & 2 for dimensions, strength and stability
- 5 year warranty on frames, 20 years on shell
- Orders of less than 10 chairs may carry a carriage charge
- Replaceable plastic feet (POA) on steel frame chair

		Seat Height mm	1-29	30+
Y100127	Stool	560	£60.30	POA
Y100128	Stool	610	£60.90	POA
Y100129	Stool	685	£63.10	POA

Y100130	High Chair	560	£73.70	POA
Y100131	High Chair	610	£74.00	POA
Y100132	High Chair	685	£78.15	POA

Frame colours (shell colours as below)



Black Dark Grey Light Grey

B. Mono one piece poly (Available Summer 2024)

- Details as above

		Seat Height mm	1-29	30+
100335	Stool	560	£60.30	POA
100336	Stool	610	£60.90	POA
100337	Stool	685	£63.10	POA

100338	High chair	560	£73.70	POA
100339	High chair	610	£74.00	POA
100340	High chair	685	£78.15	POA



C. Flow high chair

- Heavy duty construction
- 125kg weight limit
- Orders of less than 6 stools may incur a carriage charge



		Seat Height	1-29	30+
Y100125	4 Leg	610mm	£73.70	POA
Y100126	4 Leg	660mm	£73.70	POA
Y100133	Skid Frame	610mm	£88.20	POA
Y100134	Skid Frame	685mm	£88.20	POA

For critical colour matching please ask for a sample

* Only available in 430mm and 460mm high

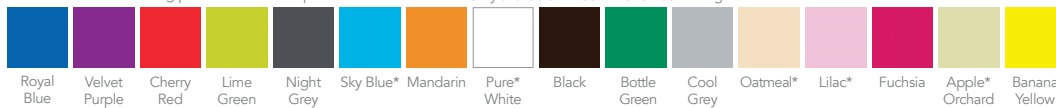

5 Year Warranty

A

Page Link - see page
Postura Task Chairs
168

B

C



20 Year
Warranty

Multipurpose Seating

A. Active balance stool

- Supports movement to assist cognitive development
- Non-slip weighted base
- Lightweight and robust
- Overall width 300mm
- 20 year warranty

	Height mm		1-29	30+
Y100228	300	Stool	£55.90	POA
Y100229	350	Stool	£58.60	POA
Y100230	400	Stool	£61.10	POA
Y100231	450	Stool	£70.50	POA
Y100341	500	Stool	£77.90	POA

Colour Options



Rose Blossom Hazy Jade Ash grey Powder Blue

Quantity
rates
available

B. Upholstered stools

- Multi-purpose upholstered stool
- Supplied with or without castors
- Ideal for libraries, break-out spaces, intervention rooms

	Height mm	Diameter	1-29	30+
Y100312	450mm	400mm	£179.00	POA

Colour Options

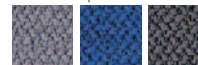

Forecast Perennial Present

Other colours available to order



Study booths/ASD desks

- Simple, cost-effective way to give privacy for the pupil who needs to concentrate
- Desktops are 800mm wide x 600mm deep with the side panels 1200mm high
- 18mm thick panels with ABS edging
- Heavy duty and special sized versions available



Pinboards and CPU holder are optional extras



Triple Single Sided



Double Single Sided



Single Sided



A. Single sided

- W836 x D645 x H1200mm

Y100207

POA



B. Double sided

- W1654 x D645 x H1200mm

Y100208

POA



C. Triple single sided

- W2472 x D645 x H1200mm

Y100209

POA



D. Single sided add-on booth

- W818 x D645 x H1200mm

Y100210

POA



E. Double sided

- W836 x D1268 x H1200mm

Y100211

POA



F. Double double sided

- W1654 x D1268 x H1200mm

Y100212

POA



G. Triple double sided

- W2472 x D1268 x H1200mm

Y100213

POA



H. Double sided add-on booth

- W818 x D1268 x H1200mm

Y100214

POA

I. CPU holder

Y100215

POA

J. Pinboard

Y100216

POA

Standard Colours

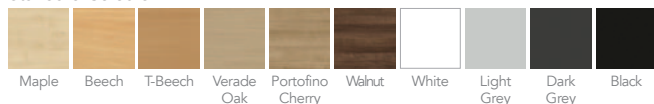

Optional Colours (at extra cost)

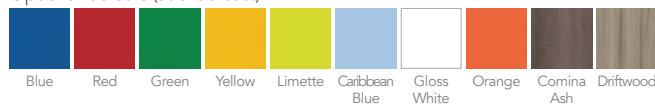

Quantity rates available

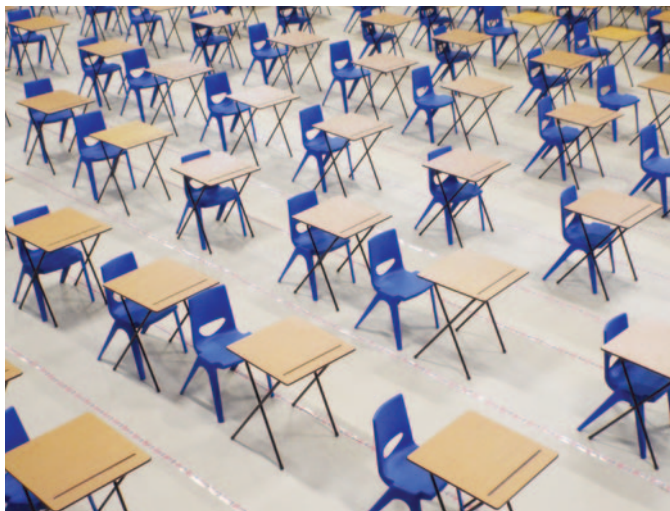
Express
DeliveryBest
Seller

Exam Desks & Trolleys

A. Exam package 1

- Great value package with 25 exam desks and a trolley
- Trolley holds 25 desks upright

		1	2+
Y15476	Package	£791.60	POA

B. Exam package 2

- Great value package with 40 exam desks and a trolley
- Trolley holds 40 desks flat

		1	2+
Y100183	Package	£1155.85	POA

**EXAM DESK HIRE AVAILABLE
PLEASE ASK FOR DETAILS**

C. Folding exam desks

- These popular exam tables have been designed to ensure they last longer and are better quality than others on the market
- The clips for the folding frame are metal and the tables have an 15mm beech laminate top with a pencil groove
- These tables provide a strong and affordable solution for all types of examination and with fold flat frames and easy to handle storage trolleys, exam preparation has never been easier
- 730mm high. Please order in multiples of 2.
- Beech, grey available to order
- Also available with blue or grey polypropylene tops for a lighter option. Please ask for details
- Premium desk has a thicker desk top and a safety bar for easier and safer assembly



Holds 40 exam desks lying flat



		10-49	50+
Y15472	Standard Exam Desk 600 x 600mm	£25.80	POA
Y16554	Premium Exam Desk 600 x 600mm	£29.90	POA

D. Exam desk trolleys

- Hold either 25 exam desks upright for safe and easy storage or 40 exam desks lying flat

		1-2	3+
Y15474	Exam Desk Trolley Holds 25 Desks Upright	£234.00	POA
Y15475	Exam Desk Trolley Holds 40 Desks Flat	£234.00	POA

Exam Desks



A. Tamperproof folding exam desk

- Ailsa Formica top resists graffiti
- Seamless, PU, impact-resistant edging
- Size: 600 x 600 x H700mm
- Pen groove included
- Speckled grey as standard, other colours available

		1-29	30+
Y100117	Tamperproof Folding Desk	£63.80	POA

Phone
For Bulk
Prices

A

B. Stacking exam tables

- These popular exam tables have a strong, black 'zimmer' frame and are FIRA tested to the highest level available, proving they are suitable for severe educational use
- Beech laminate top with MDF edge
- With pen groove
- 700mm high



		10-29	30+
Y16719	Stacking Exam Desk 600 x 500mm	£56.40	POA

Express
Delivery

B



Education resources come in all shapes and sizes
Are you storing yours in the most efficient way that makes the best use of space?

Classroom Storage

Trays	48-51	Candy Colours	73-75
Best Selling Storage Units	52-53	Curved Bookcases	76
Tray Storage	52-55,59-71	Bag Storage	77
Bookcases & Cupboards	55-58	Colorstore	78
Cubby Hole Tub Storage	65	Art Storage	79-80
Tidistore	66-67	Storage Trolleys	81-83
Premium Storage	68-69	CalStor Storage	84-85
White Storage	70-71	Metal Storage	86-90
Storage Cubes	72	Fitted Storage	91-93
Classroom Steps	72	Classtore Modular	94-95

Classroom Storage

When it comes to updating classroom storage units, there are so many diverse requirements that it takes something beyond the average range to meet your needs. That's where we can help!

The following pages showcase our unique collection of storage products, from plastic tray storage units through to bespoke fitted systems. In most cases we trust you can find the ideal solution for your needs, but if not, or to discuss your requirements, please call our sales team. We have a wealth of experience and advice, available at absolutely no cost to you.





Scooped out base gives extra strength and stability.



The Classtor lid fits perfectly onto the top of the tray.

Classic Solid Colours



Classic Translucent & Tints

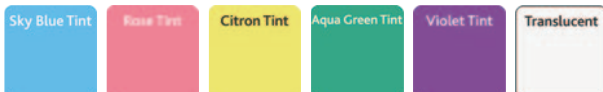

Classtor Features



Subtle rounding of corners creates a softer feel and touch.

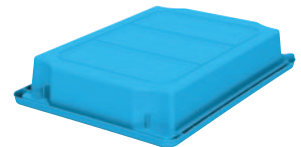

Re-enforced side rib for extra strength.



The Classtor range is available in four different sizes and over 20 industry standard colours. You can be sure that we have something to suit your requirements. Manufactured from 100% polypropylene, these trays are virtually indestructible, shatterproof and will stand up to the rigours of daily use in any learning environment.

This range will fit all standard school furniture shown in the catalogue.

Our trays are manufactured to last but at end of life they can easily be recycled.

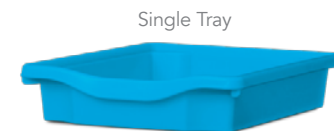
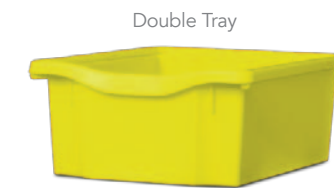
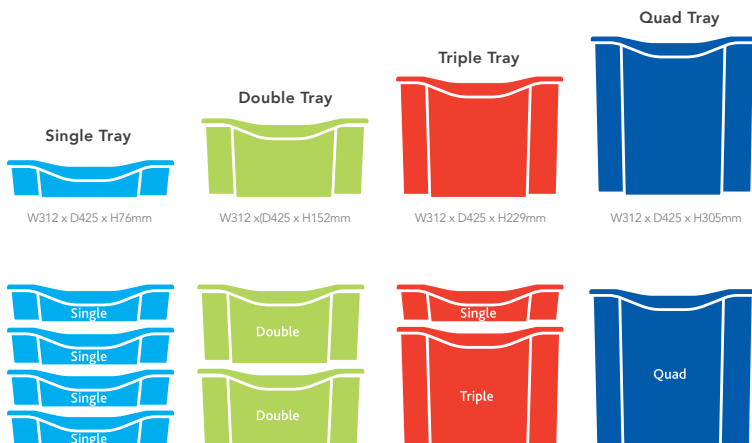

YMSTPK6	Single Tray W312 x D425 x H76mm (433 grams)	pk 6	POA
YMDTPK6	Double Tray W312 x D425 x H152mm (699 grams)	pk 6	POA
YMTTPK6	Triple Tray W312 x D425 x H229mm (878 grams)	pk 6	POA
YMQTPK6	Quad Tray W312 x D425 x H305mm (1048 grams)	pk 6	POA
YMTLPK6	Tray Lid In Classic Translucent one size fits all Classtor trays	pk 6	POA

Gratnell's tray range

- Trays are available in shallow, deep, extra deep and jumbo sizes
- Some colours are not available in all sizes, see below for availability



Lifetime guarantee



100% recyclable



Safe heavy educational use



Tray colours: Availability: S=Shallow, D=Deep, E=Extra Deep, J=Jumbo



Stock Colours

YSTRAY12	Shallow Tray	W312 x D427 x H75mm	pk 12	POA
YDTRAY6	Deep Tray	W312 x D427 x H150mm	pk 6	POA
YEDTRAY6	Extra Deep Tray	W312 x D427 x H225mm	pk 6	POA
YJTRAY6	Jumbo Tray	W312 x D427 x H300mm	pk 6	POA
YTLID6	Clear Tray Lid		pk 6	POA

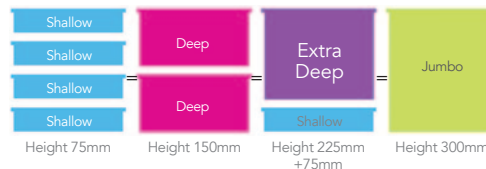

Gratnell's Antimicrobial Trays

For greater infection control the trays known for standing up to rigorous daily use are now available with a built-in Antimicrobial protection.

BioCote® antimicrobial protection is introduced to the trays during the manufacturing process to provide built-in protection against the effects of microbes. This means surfaces need no longer rely solely on continual wash-downs to guard against infection

These compact trays are from Gratnells medical range, widely used in the NHS, surgeries and clinics, as well as being fully compatible with Gratnells iconic school storage range found worldwide. Ideal for safe storage of medical, school or first aid equipment.

Antimicrobial Trays

YSTR12AM	Shallow Tray	W312 x D427 x H75mm	pk 12	POA
YDTR6AM	Deep Tray	W312 x D427 x H150mm	pk 6	POA
YEDTR6AM	Extra Deep Tray	W312 x D427 x H225mm	pk 6	POA
YJTR6AM	Jumbo Tray	W312 x D427 x H300mm	pk 6	POA
YTLID6AM	Clear Tray Lid		pk 6	POA

- 99.9% reduction in surface contamination after 2 hours
- Provides protection from a variety of bacteria, fungi, mould and Viruses including the H1N1 u virus
- Made in the UK and fully recyclable. Guaranteed for five years
- Choose green tint or translucent and shallow, deep, extra deep and jumbo sizes



Tray Storage Units Overview

Checklist for Choosing and Specifying Your Unit

1. How many trays do you need?
2. And of what depth? Note that within the price you can specify any mix of depths which will physically fit the unit.
1 x Deep tray = 2 x Shallow, 1 x Extra Deep = 3 x Shallow and 1 x Jumbo = 4 x Shallow.
3. Is there a preferred, uniform, top surface height? Look for the height icon h1, h2 etc which gives the height in mm.
4. How many bays wide for best fit into your workspaces? Units are available in 1, 2, 3 or even 4 columns of trays wide.
5. Carcass design - trays sliding on runners or sitting directly onto a shelf?
6. Castors or Fixed Plinth? Smaller units are fitted with castors as standard but some items can be specified with a static plinth at no extra cost. Note: heights quoted include height of castors.
7. Doors – locking doors can be fitted to most units as an optional extra.
8. Wood finish / Metal Frame Colours – Our standard MFC wood finishes are Beech (BE) or Maple (MP) but please ask for details of production order quantities and lead times for manufacturing in Grey, White, or other special finishes. Standard Metal Frame colour options are Silver, Powder Blue & Yellow. See page 86 for colour icons.
9. Select your mix of tray colours (and depths) from the extensive range available – see chart on page 50.
10. For fitted installations see Classtore Modular system on pages 94-95.



65mm Castors

Plinth

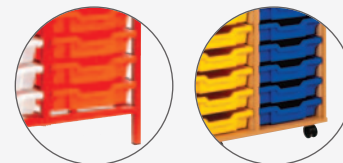

Best Selling Storage Units



- All units supplied complete with trays within the price. See pages 48-51 for colours and size options
- Choice of Beech or Maple finish. Ask our sales office for details on other finishes available
- Colour and size options: you can fill your unit with any combination of tray depth and colour which will fit into the space



h2
height
617mm



A. 6 tray unit

- W360 x D453 x H617mm

Y15116	Beech, Open Front	£122.00
Y15118	Beech with Locking Door	£183.00
Y203000	Maple, Open Front	£122.00
Y203002	Maple with Locking Door	£183.00

h2
height
617mm



B. 12 tray unit

- W700 x D453 x H617mm

Y15120	Beech, Open Front	£208.00
Y15122	Beech with Locking Door	£306.00
Y203004	Maple, Open Front	£208.00
Y203006	Maple with Locking Door	£306.00

h2
height
617mm

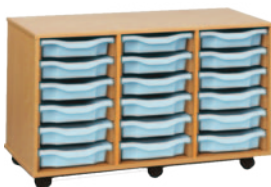

C. 18 tray unit

- W1030 x D453 x H617mm

Y15124	Beech, Open Front	£257.00
Y15126	Beech with Locking Door	£338.00
Y203008	Maple, Open Front	£257.00
Y203010	Maple with Locking Door	£338.00

h4
height
789mm



D. 24 tray unit

- W1030 x D453 x H789mm

Y15128	Beech, Open Front	£336.00
Y15130	Beech with Locking Door	£380.00
Y203012	Maple, Open Front	£336.00
Y203014	Maple with Locking Door	£380.00



Colours



Page Link - see pages

For
bookcases
& cupboards

55-57



Best Selling Storage Units



- All units supplied complete with trays within the price. See pages 48-51 for colours and size options
- Choice of Beech or Maple finish. Ask our sales office for details on other finishes available
- Colour and size options: you can fill your unit with any combination of tray depth and colour which will fit into the space



h5
height
961mm



A. 30 tray unit

- W1030 x D453 x H961mm

Y17005	Beech, Open Front	£448.00
Y17007	Beech with Locking Door	£521.00
Y203016	Maple, Open Front	£448.00
Y203018	Maple with Locking Door	£521.00

h3
height
703mm



B. 21 tray units

- W1030 x D453 x H703mm

Y15125	Beech, Open Front	£331.00
Y15127	Beech with Locking Door	£410.00
Y203020	Maple, Open Front	£331.00
Y203022	Maple with Locking Door	£410.00

h4
height
789mm



C. 8 & 16 tray units

- D453 x H789mm
- 8 tray unit width 360mm, 16 tray unit width 700mm

	No Doors		With Doors	
Beech 8 Tray Unit	Y15119	£158.00	Y15119WD	£195.00
Beech 16 Tray Unit	Y15123	£258.00	Y15123WD	£331.00
Maple 8 Tray Unit	Y203024	£158.00	Y203024WD	£195.00
Maple 16 Tray Unit	Y203026	£258.00	Y203026WD	£331.00

h4
height
789mm



h2
height
617mm

D. 6 & 8 tray shelving units

- W1030 x D453mm
- 6 tray height 617mm, 8 tray height 789mm
- 2 adjustable shelves

	No Doors		With Doors	
Beech 6 Tray	Y15129	£264.00	Y15129WD	£337.00
Beech 8 Tray	Y15131	£282.00	Y15131WD	£355.00
Maple 6 Tray s	Y203028	£264.00	Y203028WD	£337.00
Maple 8 Tray	Y203030	£282.00	Y203030WD	£355.00



Colours



Four Column Tray Units



- All units supplied complete with trays within the price. See pages 48-51 for colours and size options
- Choice of Beech or Maple finish. Ask our sales office for details on other finishes available
- Colour and size options: you can fill your unit with any combination of tray depth and colour which will fit into the space



h7
height
1477mm



A. 64 tray unit

- W1358 x D462 x H1477mm

Y15716	Beech Open Front	£786.00
Y203032	Maple Open Front	£786.00

h6
height
1133mm



B. 48 tray unit

- W1358 x D462 x H1133mm

Y15133	Beech Open Front	£632.00
Y15133D	Beech with Doors	£706.00
Y203034	Maple Open Front	£632.00
Y203034D	Maple with Doors	£706.00

h5
height
961mm



C. 40 tray unit

- W1358 x D462 x H961mm

Y15713	Beech Open Front	£548.00
Y203036	Maple Open Front	£548.00

h4
height
789mm



D. 32 tray unit

- W1358 x D462 x H789mm

Y15705	Beech Open Front	£461.00
Y15707	Beech, with Locking Doors	£535.00
Y203038	Maple Open Front	£461.00
Y203040	Maple, with Locking Doors	£535.00

h3
height
703mm



E. 28 tray unit

- W1358 x D462 x H703mm

Y15710	Beech Open Front	£420.00
Y15711	Beech, with Locking Doors	£493.00
Y203042	Maple Open Front	£420.00
Y203044	Maple, with Locking Doors	£493.00

h2
height
617mm



F. 24 tray unit

- W1358 x D462 x H617mm

Y15733	Beech Open Front	£385.00
Y15737	Beech, with Locking Doors	£458.00
Y203046	Maple Open Front	£385.00
Y203048	Maple, with Locking Doors	£458.00

h1
height
531mm



G. 20 tray unit

- W1358 x D462 x H531mm

Y15719	Beech Open Front	£352.00
Y15719D	Beech with Doors	£426.00
Y203050	Maple Open Front	£352.00
Y203050D	Maple with Doors	£426.00

Colours



Tray Storage Cupboards



- All cupboards supplied with trays included in the price. Specify any combination of sizes and colours which will fit into the tray compartment
- Choice of Beech or Maple finish. Ask our sales office for details on other finishes available



Colours



Maple Beech



A. 20 tray cupboard unit

- Tray storage with 20 single depth trays
- 1 fixed and 4 adjustable shelves
- W1030 x D485 x H1810mm

Y15175S	Beech with Locking Doors	£746.00
Y15176S	Maple, with Locking Doors	£746.00

Can also be supplied with different tray sizes



B. 21 tray cupboard unit

- Tray storage for 21 trays and 3 additional shelves
- W1030 x D477 x H1810mm

Y15172	Beech with Locking Doors	£624.00
Y203052	Maple with Locking Doors	£624.00



C. 24 tray cupboard unit

- Storage for 24 trays and 2 additional shelves
- Full or half doors available
- W1030 x D477 x H1468mm

Y15728	Beech, Locking Top Doors	£554.00
Y15738C	Beech, Locking Full Doors	£631.00
Y203054	Maple, Locking Top Doors	£554.00
Y203056	Maple, Locking Full Doors	£631.00



D. 48 tray cupboard unit

- W1030 x D477 x H1468mm

Y17081	Beech Open Front	£643.00
Y17083	Beech, with Locking Doors	£739.00
Y203058	Maple Open Front	£643.00
Y203060	Maple, with Locking Doors	£739.00



E. 60 tray cupboard unit

- W1030 x D477 x H1810mm

Y15178	Beech Open Front	£664.00
Y15176	Beech, with Locking Doors	£788.00
Y203062	Maple Open Front	£664.00
Y203064	Maple, with Locking Doors	£788.00

Open Bookcases



- This popular range of open bookcases has been specifically designed for severe classroom environments
- All now available in Beech, Maple or White finish
- Strong, 25mm bend-resistant shelves



Best Seller

Phone For Bulk Prices



A. Bookcase 750

- 2 adjustable shelves
- W900 x D320 x H750mm

Y15183	Beech	£174.00
Y200050	Maple	£174.00
Y200051	White	£215.00



B. Bookcase 1000

- 2 adjustable shelves
- W900 x D320 x H1000mm

Y15182	Beech	£189.00
Y200052	Maple	£189.00
Y200053	White	£235.00



C. Bookcase 1250

- 1 fixed and 2 adjustable shelves
- W900 x D320 x H1250mm

Y15193	Beech	£203.00
Y200054	Maple	£203.00
Y200055	White	£250.00



Bend-resistant 25mm shelves



D. Bookcase 1500

- 1 fixed and 2 adjustable shelves
- W900 x D320 x H1500mm

Y15731	Beech	£218.00
Y200056	Maple	£218.00
Y200057	White	£266.00



E. Bookcase 1800

- 1 fixed and 4 adjustable shelves
- W900 x D320 x H1800mm

Y15186	Beech	£233.00
Y200058	Maple	£233.00
Y200059	White	£288.00



All now available in White MFC finish



Page Link - see pages

For library units...

204-211



Lockable Storage Cupboards



- This popular range of storage cupboards has been specifically designed for severe classroom environments
- All now available in Beech, Maple or White finish
- Strong, 25mm bend-resistant shelves



Best Seller



A. Cupboard 750

- 2 adjustable shelves
- W1024 x D477 x H768mm

Y15181	Beech	£315.00
Y200070	Maple	£315.00
Y200071	White	£365.00



B. Cupboard 1000

- 1 fixed and 2 adjustable shelves
- W1024 x D477 x H1018mm

Y15180	Beech	£334.00
Y200072	Maple	£334.00
Y200073	White	£412.00



C. Cupboard 1250

- 1 fixed and 2 adjustable shelves
- W1024 x D477 x H1268mm

Y15191	Beech	£363.00
Y200074	Maple	£363.00
Y200075	White	£418.00



D. Cupboard 1500

- 1 fixed and 2 adjustable shelves
- W1024 x D477 x H1518mm

Y15730C	Beech	£393.00
Y200076	Maple	£393.00
Y200077	White	£432.00



Bend-resistant 25mm shelves

E. Cupboard 1800

- 1 fixed and 4 adjustable shelves
- W1024 x D477 x H1818mm

Y15184	Beech	£422.00
Y200078	Maple	£422.00
Y200079	White	£443.00



All now available in White MFC finish

Carcass colours



Coloured Edge Bookcases & Cupboards



- Popular range of open shelf or cupboard storage with the enhancement of colour edging trims
- Strong 25mm bend-resistant shelves
- Supplied in Beech



Bend-resistant
25mm shelves

A. High bookcase unit

- 1 fixed and 4 adjustable shelves
- Open Bookcases W900 x D320 x H1800mm

Y15223	Bookcase - Red Edge	£257.00
Y15227	Bookcase - Blue Edge	£257.00
Y15229	Bookcase - Green Edge	£257.00



B. Medium bookcase unit

- 1 fixed and 2 adjustable shelves
- Open Bookcases W900 x D320 x H1250mm

Y15212	Bookcase - Red Edge	£228.00
Y15214	Bookcase - Blue Edge	£228.00
Y15216	Bookcase - Green Edge	£228.00



C. Low bookcase unit

- 2 adjustable shelves
- Open Bookcases W900 x D320 x H750mm

Y15211	Bookcase - Red Edge	£199.00
Y15213	Bookcase - Blue Edge	£199.00
Y15215	Bookcase - Green Edge	£199.00



D. Low cupboard unit

- 2 adjustable shelves
- Cupboards with doors W1030 x D477 x H768mm

Y15201	Cupboard - Red Edge	£316.00
Y15203	Cupboard - Blue Edge	£316.00
Y15205	Cupboard - Green Edge	£316.00



E. Medium cupboard unit

- 1 fixed and 2 adjustable shelves
- Cupboards w/doors W1030 x D477 x H1268mm

Y15206	Cupboard - Red Edge	£401.00
Y15208	Cupboard - Blue Edge	£401.00
Y15210	Cupboard - Green Edge	£401.00



F. High cupboard unit

- 1 fixed and 4 adjustable shelves
- Cupboards w/doors W1030 x D477 x H1818mm

Y15217	Cupboard - Red Edge	£431.00
Y15219	Cupboard - Blue Edge	£431.00
Y15221	Cupboard - Green Edge	£431.00



Coloured Edge Storage



- All units supplied complete with trays within the price. See pages 48-51 for colours and size options
- Supplied in Beech



A. 12 quad tray unit

- W1358 x D453 x H1067mm

Y15200	With Red Edge	£498.00
Y15202	With Blue Edge	£498.00
Y15204	With Green Edge	£498.00



B. 8 quad tray unit

- W1358 x D453 x H739mm

Y15231	With Red Edge	£427.00
Y15233	With Blue Edge	£427.00
Y15235	With Green Edge	£427.00

h4
height
789mm



C. 24 tray unit

- W1030 x D453 x H789mm

Y15194	With Red Edge	£348.00
Y15196	With Blue Edge	£348.00
Y15198	With Green Edge	£348.00



h2
height
617mm

D. 18 tray unit

- W1030 x D453 x H617mm

Y15188	With Red Edge	£304.00
Y15190	With Blue Edge	£304.00
Y15192	With Green Edge	£304.00



h2
height
617mm

E. 12 tray unit

- W700 x D453 x H617mm

Y17100	With Red Edge	£269.00
Y17102	With Blue Edge	£269.00
Y17104	With Green Edge	£269.00

h2
height
617mm



F. 6 tray unit

- W360 x D453 x H617mm

Y17106	With Red Edge	£161.00
Y17108	With Blue Edge	£161.00
Y17110	With Green Edge	£161.00



Page Link - see pages

For early
years
units...

125-126



Quad Depth Storage Units



- These units are extremely popular, offering organised storage capacity for large, messy and heavy items
- All units supplied complete with trays within the price. See pages 48-51 for colours and size options
- Choice of Beech or Maple finish. Ask our sales office for details on other finishes available



Extra Value

A. 12 tray unit

- W1358 x D453 x H1067mm

Y15148	Beech, Open Front	£441.00
Y203065	Maple, Open Front	£441.00



Extra Value

B. 8 tray unit

- W1358 x D453 x H739mm

Y157198	Beech, Open Front	£370.00
Y203068	Maple, Open Front	£370.00



C. 9 tray unit

- W1030 x D453 x H1067mm

Y15137	Beech, Open Front	£383.00
Y15143	Beech with Locking Doors	£562.00
Y203072	Maple, Open Front	£383.00
Y203074	Maple with Locking Doors	£562.00



D. 6 tray tall unit

- W700 x D453 x H1067mm

Y17045	Beech, Open Front	£338.00
Y17047	Beech with Locking Doors	£411.00
Y203076	Maple, Open Front	£338.00
Y203078	Maple with Locking Doors	£411.00



E. 6 tray wide unit

- W1030 x D453 x H739mm

Y17049	Beech, Open Front	£461.00
Y203080	Maple, Open Front	£461.00



F. 4 tray unit

- W700 x D453 x H739mm

Y17053	Beech, Open Front	£331.00
Y203084	Maple, Open Front	£331.00



Colours



Maple Beech



Double & Triple Depth Storage Units

- These units are extremely popular, offering organised storage capacity for large, messy and heavy items
- All units supplied complete with trays within the price. See pages 48-51 for colours and size options
- Choice of Beech or Maple finish. Ask our sales office for details on other finishes available



A. 12 double depth tray unit vertical

- W1030 x D453 x H835mm

Y200210	Beech Open Front	£406.00
Y203088	Maple Open Front	£406.00



B. 12 double depth tray horizontal

- W1358 x D453 x H707mm

Y200212	Beech Open Front	£406.00
Y203090	Maple Open Front	£406.00



C. 16 double depth tray unit

- W1348xD453XH835mm

Y200214	Beech Open Front	£507.00
Y203092	Maple Open Front	£507.00



D. 18 double depth tray unit

- W1030 x D453 x H1210mm

Y200216	Beech Open Front	£538.00
Y203094	Maple Open Front	£538.00



E. 6 triple depth tray unit

- W700 x D453 x H857mm

Y17061	Beech, Open Front	£268.00
Y17063	Beech with Locking Doors	£341.00
Y203096	Maple, Open Front	£268.00
Y203098	Maple with Locking Doors	£341.00



F. 12 triple depth tray unit

- W1358 x D453 x H857mm

Y1571912	Beech, Open Front	£470.00
Y1572012	Beech with Locking Doors	£543.00
Y203100	Maple, Open Front	£470.00
Y203102	Maple with Locking Doors	£543.00



G. 16 triple depth tray unit

- W1358 x D453 x H1115mm

Y1572516	Beech, Open Front	£585.00
Y1572616	Beech with Locking Doors	£659.00
Y203104	Maple, Open Front	£585.00
Y203106	Maple with Locking Doors	£659.00



Colours



Page Link - see pages
More triple depth units... [70-71](#)



Combination Storage Units



- Choice of Beech or Maple finish
- All units can also be made as static unit, fitted with plinth at no extra cost - specify if required
- All units supplied complete with trays within the price - See page 48-51 for colour options
- Units can be combined with the open shelf unit on the following page to make tall units

h2
height
617mm



A. Open front variety unit

- Unit holds 4 triple depth trays on the left and 12 single or 6 double depth trays on the right
- W1358 x D453 x H617mm

Y15729	Beech Mobile - Open Front	£427.00
Y1573610	Beech, Static - Open Front	£427.00
Y203108	Maple Mobile - Open Front	£427.00
Y203110	Maple, Static - Open Front	£427.00



C. 32 single or 16 double depth tray unit

- W1358 x D453 x H835mm
- Can mix between single or double depth trays

Y15132	Beech, Open Front	£507.00
Y15134	Beech with Locking Doors	£581.00
Y203116	Maple, Open Front	£507.00
Y203118	Maple with Locking Doors	£581.00



B. 24 single or 12 double depth tray unit

- W1358 x D453 x H707mm
- Can mix between single or double depth trays

Y17057	Beech, Open Front	£406.00
Y17059	Beech with Locking Doors	£479.00
Y203112	Maple, Open Front	£406.00
Y203114	Maple with Locking Doors	£479.00



D. 36 single or 18 double depth tray unit

- A popular, large capacity unit with 36 single or 18 double depth trays, or a combination of both
- W1030 x D453 x H1210mm

Y15140	Beech, Open Front	£538.00
Y15142	Beech with Locking Doors	£612.00
Y203120	Maple, Open Front	£538.00
Y203122	Maple with Locking Doors	£612.00



Colours



Combination Tray Units



- Choice of Beech or Maple finish
- All units can also be made as static unit, fitted with plinth at no extra cost - specify if required
- All units supplied complete with trays within the price - See pages 48-51 for colour options
- Tray units can be combined with the open shelf unit below to make tall units

Phone For Bulk Prices



A. 16 single, 4 double and 3 triple depth tray unit

- Dimensions: W1358 x D453 x H842mm

Y15145	Beech, 23 Tray, Open Front	£496.00
Y203124	Maple, 23 Tray, Open Front	£496.00



B. 8 double and 6 triple depth tray unit

- Dimensions: W1358 x D453 x H842mm

Y17065	Beech, 14 Tray, Open Front	£496.00
Y203128	Maple, 14 Tray, Open Front	£496.00



C. 16 single and 6 triple depth tray unit

- Dimensions: W1358 x D453 x H842mm

Y17067	Beech, 22 Tray, Open Front	£485.00
Y203132	Maple, 22 Tray, Open Front	£485.00



D. Open shelf unit with 4 compartments

- Sits on top of base units
- Can be securely fixed with locking pins

Y203136	Beech Finish	£231.00
Y203138	Maple Finish	£231.00

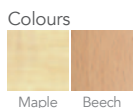

Pick & mix your trays

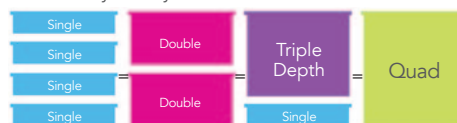

Variety Storage Units

- Choice of Beech or Maple finish
- Items A and B can also be made as static unit, fitted with plinth at no extra cost - specify if required
- All units supplied complete with trays within the price - See pages 48-51 for colour options

Colours



Maple Beech



A. 12 tray variety

- Takes 4 quad trays, 4 double depth trays, mix and match colours as you wish
- W1358 x D453 x H707mm

Y15156	Beech, Mobile, Open Front	£441.00
Y15158	Beech, Mobile, Locking Doors	£507.00
Y15162	Beech, Static, Locking Doors	£507.00
Y203140	Maple, Mobile, Open Front	£441.00
Y203142	Maple, Mobile, Locking Doors	£507.00
Y203144	Maple, Static, Locking Doors	£507.00



C. 12 tray vertical variety

- Contains 3 of each tray size: single, double, triple & quad depth
- W1030 x D453 x H967mm

Y202000	Beech, Mobile, Open Front	£448.00
Y203146	Maple, Mobile, Open Front	£448.00
Y202000D	Beech, Mobile, with Doors	£522.00
Y203146D	Maple, Mobile, with Doors	£522.00



B. 16 tray variety

- A bigger version of the unit above, this variety tray storage unit holds 4 single trays, 4 double trays, 4 triple trays, and 4 quad depth trays
- W1358 x D453 x H967mm

Y15164	Beech, Mobile, Open Front	£544.00
Y15166	Beech, Mobile, Locking Doors	£618.00
Y15170	Beech, Static, Locking Doors	£618.00
Y203148	Maple, Mobile, Open Front	£544.00
Y203150	Maple, Mobile, Locking Doors	£618.00
Y203152	Maple, Static, Locking Doors	£618.00



D. 8 tray narrow variety unit

- Takes 2 x single, 2 x double, 2 x triple, 2 x quad depth trays
- W700 x D453 x H967mm

Y151108	Beech, Mobile, Open Front	£356.00
Y203156	Maple, Mobile, Open Front	£356.00

Cubby Hole Tub Storage



- Smaller sizes than our regular tray storage range, so ideal for younger years, or where space is limited
- Units supplied fully assembled
- Beech-BE or Maple-ML
- Units supplied with Strata trays included in the price



A. 6 tray unit
• W620 x D450 x H810mm

Y200521 £208.00



B. 12 tray unit
• W1220 x D450 x H810mm

Y200561 £386.30



C. 18 tray unit
• W940 x D450 x H1530mm

Y200591 £502.00



D. 3 column low tub storage unit
• W940 x D450 x H580mm

Y200501 6 Tub Unit, Open Front £244.00



E. 2 column tall tub storage unit
• W620 x D450 x H1220mm

Y200581 10 Tub Unit, Open Front £340.10



F. 3 column mid height tub storage unit
• W940 x D450 x H810mm

Y200541 9 Tub Unit, Open Front £267.10

Carcass colours

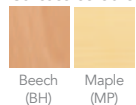

Trays available in:

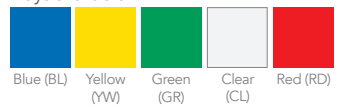

Tidistore Storage Range



- The Tidistore Storage Units are a versatile stackable storage solution that can be customised to suit every classroom
- Each unit comes complete with castors and locating pins which are used when stacking
- All Tidistore units can be stacked with each other to make a whole combination of different storage requirements
- All units come fully assembled in either Beech or Maple carcass - please specify. Ask our sales office for details on other finishes available
- All units supplied complete with trays within the price. See pages 48-51 for colour and size options
- Height includes 65mm castors



Stackable



A. Tidistore 24 tray unit

- W1030 x D453 x H810mm

Y15128AS	Beech	£364.00
Y203160	Maple	£364.00

B. Tidistore 12 tray unit

- W1030 x D453 x H810mm

Y1524512	Beech	£364.00
Y203162	Maple	£364.00

C. Tidistore 6 tray unit

- W1030 x D453 x H810mm

Y152476	Beech	£364.00
Y203164	Maple	£364.00



D. Tidistore 16 tray unit

- W700 x D453 x H810mm

Y15249	Beech	£325.00
Y203166	Maple	£325.00

E. Tidistore 8 tray unit

- W700 x D453 x H810mm

Y15245	Beech	£325.00
Y203168	Maple	£325.00

F. Tidistore 4 tray unit

- W700 x D453 x H810mm

Y15247	Beech	£325.00
Y203170	Maple	£325.00



Colours

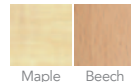

Maple Beech

Tidistore Storage Range



These items
are Stackable



A. Tidistore unit with 1 shelf

- W700 x D453 x H810mm

Y15241	Beech	£265.00
Y203172	Maple	£265.00

B. Tidistore unit with 4 compartments

- W700 x D453 x H810mm

Y15243	Beech	£265.00
Y203174	Maple	£265.00



Colours



Maple Beech

Stackable White Storage Units

- New range of stacking modular storage units
- By using just 4 component modules many different storage combinations can be built
- Supplied fully assembled



Units stacked over
2 metres tall will
require wall fixing



C. 4 squares unit

- W700 x D453 x H745mm

Y200020	£351.00
---------	---------

D. 4 jumbo tray unit

- W700 x D453 x H810mm

Y200022	£410.00
---------	---------

Page Link - see page

For
buying
guide...

48-51



Premium Storage Range



- New range of premium storage units in a choice of White or Grey finish
- Add a choice of brightly coloured trays for a clean, modern look
- All tray units contain clear plastic tray runners
- Units are supplied with plinths as standard, but most are also available fitted with castors at no additional charge - please ask for details
- All units supplied complete with trays as shown, within the price
- See pages 48-51 for colour & size options.



h2
height
617mm

A. 6 tray unit

- W363 x D475 x H617mm

Y203182	White, No Doors	£161.00
Y203184	White, with Locking Doors	£193.00
Y203186	Grey, No Doors	£161.00
Y203188	Grey, with Locking Doors	£193.00



h4
height
789mm

B. 8 tray unit

- W363 x D475 x H789mm

Y203190	White, No Doors	£171.00
Y203192	White, with Locking Doors	£203.00
Y203194	Grey, No Doors	£171.00
Y203196	Grey, with Locking Doors	£203.00



C. 12 tray unit

- W704 x D475 x H617mm

Y203198	White, No Doors	£235.00
Y203200	White, with Locking Doors	£278.00
Y203202	Grey, No Doors	£235.00
Y203204	Grey, with Locking Doors	£278.00



h4
height
789mm

D. 16 tray unit

- W704 x D475 x H789mm

Y203206	White, No Doors	£257.00
Y203208	White, with Locking Doors	£300.00
Y203210	Grey, No Doors	£257.00
Y203212	Grey, with Locking Doors	£300.00



h2
height
617mm

E. 18 tray unit

- W1045 x D475 x H617mm

Y203214	White, No Doors	£321.00
Y203216	White, with Locking Doors	£375.00
Y203218	Grey, No Doors	£321.00
Y203220	Grey, with Locking Doors	£375.00



h4
height
789mm

F. 24 tray unit

- W1045 x D475 x H789mm

Y203222	White, No Doors	£375.00
Y203224	White, with Locking Doors	£439.00
Y203226	Grey, No Doors	£375.00
Y203228	Grey, with Locking Doors	£439.00

Premium Storage Range



- New range of premium storage units in a choice of White or Grey finish
- Add a choice of brightly coloured trays for a clean, modern look
- All tray units contain clear plastic tray runners
- Units are supplied with plinths as standard, but most are also available fitted with castors at no additional charge - please ask for details
- All units supplied complete with trays as shown, within the price
- See pages 48-51 for colour & size options



A. 6 tray shelving unit

- 2 shelf compartment & 6 shallow trays
- W1045 x D475 x H617mm

Y203230	White, No Doors	£300.00
Y203232	White, with Locking Doors	£353.00
Y203234	Grey, No Doors	£300.00
Y203236	Grey, with Locking Doors	£353.00



B. 8 tray shelving unit

- 2 shelf compartment & 8 shallow trays
- W1045 x D475 x H789mm

Y203238	White, No Doors	£342.00
Y203240	White, with Locking Doors	£407.00
Y203242	Grey, No Doors	£342.00
Y203244	Grey, with Locking Doors	£407.00



C. 21 tray cupboard

- W1045 x D475 x H1818mm
- Supplied c/w 21 trays

Y203246	White, with Locking Doors	£749.00
Y203248	Grey, with Locking Doors	£749.00



D. Low cupboard

- W1045 x D465 x H617mm

Y203250	White, No Doors	£273.00
Y203252	White, with Locking Doors	£315.00
Y203254	Grey, No Doors	£273.00
Y203256	Grey, with Locking Doors	£315.00



E. Medium cupboard

- W1045 x D475 x H789mm

Y203258	White, No Doors	£305.00
Y203260	White, with Locking Doors	£347.00
Y203262	Grey, No Doors	£305.00
Y203264	Grey, with Locking Doors	£347.00



F. Tall cupboard

- W1045 x D475 x H1818mm

Y203266	White, No Doors	£358.00
Y203268	White, with Locking Doors	£421.00
Y203270	Grey, No Doors	£358.00
Y203272	Grey, with Locking Doors	£421.00

White Range



- 13 popular tray units available in white finish
- Supplied complete with trays
- Remember to state your choice of tray colours
- Also available with plinths
- See pages 48-51 for tray colours

Phone
For Bulk
Prices



A. 4 tray unit

- W690 x D460 x H779mm

Y203750W

£298.00



B. 8 tray unit

- W1358 x D460 x H779mm

Y203752W

£422.00



C. 12 tray unit

- W1358 x D460 x H1107mm

Y203754W

£569.00



D. 6 wide tray unit

- W1024 x D460 x H779mm

Y203756W

£383.00

White Range



Page Link - see page
For buying guide... 48-51



A. 12 variety tray unit
• W1358 x D453 x H707mm

Y15156W £545.00



B. 16 variety tray unit
• W1358 x D453 x H967mm

Y15164W Mobile £595.00



C. 12 triple depth tray unit
• W1358 x D453 x H857mm

Y1571912W £559.00



D. 16 triple depth tray unit
• W1358 x D453 x H1115mm

Y1572516W £647.00



E. 12 double depth tray unit
• W1358 x D453 x H707mm

Y17057W £492.00



F. 16 double depth tray unit
• W1358 x D453 x H835mm

Y15132W £587.00



G. 18 double depth tray unit
• W1030 x D453 x H1210mm

Y17080W £595.00



H. 12 double depth tray unit
• W1030 x D453 x H835mm

Y17084W £492.00



I. 8 double & 6 triple depth tray unit
• W1358 x D453 x H842mm

Y17065W 14 Tray Unit £569.00

Storage Cubes

- A brilliant and convenient method of storage that makes excellent use of any space you're trying to fill in your learning environments.
- Available in 2, 3, 4 & 5 cubes high and a range of colours including Beech, Maple or White carcass and Blue, Plum, Red, Lilac, Lime, Jaffa, Sage, Powder Blue, Stone Grey, Graphite and Fjord Green

Please specify carcass colour

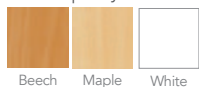

Beech Maple White

Please specify backing colour



Blue Plum Red Lilac Lime Jaffa



Sage Powder Blue Stone Grey Graphite Fjord Green



A. Double Column Storage Cubes

	No. Cubes	Size	
Y203722	4	H1000 x W750 x D350	£339.00
Y203723	6	H1250 x W750 x D350	£386.00
Y203724	8	H1500 x W750 x D350	£441.00
Y203725	10	H2000 x W750 x D350	£483.00

B. Triple Column Storage Cubes

	No. Cubes	Size	
Y203732	6	H1000 x W1000 x D350	£377.00
Y203733	9	H1250 x W1000 x D350	£439.00
Y203734	12	H1500 x W1000 x D350	£510.00
Y203735	15	H2000 x W1000 x D350	£535.00

Classroom Step

- Our high quality, secure & strong Classroom Step used in front of your active whiteboards to aid younger pupils to reach the screen and participate in front of the class
- Built using a high quality 18mm solid MDF in a choice of finishes with a solid navy blue carpet finish on every step
- Available in Beech, Grey, Maple, Oak, White
- Supplied with Gratnells trays in a choice of colours

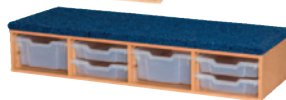
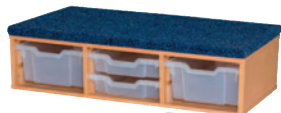

C. Triple Column Step

- Available in 2 Deep & 2 Shallow Gratnells trays
- Height: 250 Width: 1025 Depth: 500
- Or 2 Extra Deep & 3 Shallow Gratnells trays
- Height: 355 Width: 1025 Depth: 500

Y203740	2 Deep & 2 Shallow	£335.00
Y203741	2 Deep & 3 Shallow	£364.00

D. Quadruple Column Step

- Available in 2 Deep & 4 Shallow Gratnells trays
- Height: 250 Width: 1355 Depth: 500
- Or 2 Extra Deep & 6 Shallow Gratnells trays
- Height: 335 Width: 1355 Depth: 500

Y203742	2 Deep & 4 Shallow	£352.00
Y203743	2 Deep & 6 Shallow	£381.00

E. Quintuple Column Step

- Available in 3 Deep & 4 Shallow Gratnells trays
- Height: 250 Width: 1690 Depth: 500
- Or 3 Extra Deep & 6 Shallow Gratnells trays
- Height: 335 Width: 1690 Depth: 500

Y203744	3 Deep & 4 Shallow	£436.00
Y203745	3 Deep & 6 Shallow	£456.00

The Candy Colours Range



- All units supplied complete with trays within the price. See pages 48-51 for colours and size options
- Please specify top rail theme colour - Lime Green, Cyan Blue, Tangerine or White



A. 6 bay kinderbox with 12 single or 6 double depth trays

- W1022 x D473 x H600mm

Y17023 6 Bay Kinderbox £421.00



B Candy book house

- Made from 18mm Maple MFC with ply effect edging
- Choose from Lime, Tangerine, White and Cyan
- Dimensions: W910 x D568 x H1101mm

YBH9000 Book House with Trays £339.00



C. Mobile art storage cupboard

- Made in Maple MFC with bright coloured interior door panels
- W1085 x D600 x H1503mm
- Supplied with 16 x trays (or equivalent in larger trays)
- Other contents not included

Y17038 Art Storage Cupboard £1126.00

Please specify colour



Page Link - see pages

Early years & Candy Colours cloakroom range

152



Page Link - see pages

Book shelves & library furniture

204-211



D. 6 bay kinderbox (coloured inner panels)

Y17033 With Wheels W886 x D600 x H273mm £245.00

Y17035 With Legs W886 x D600 x H430mm £245.00



E. Angled tray unit c/w 6 double depth trays

- W1030 x D481 x H898mm

Y200190 Angled Shelf Unit £351.00

Candy Colours Room Dividers

- Backless storage units which can be used free standing or stacked on top of co-ordinating cupboards for additional storage space
- Please specify panel colour – Lime Green, Cyan Blue, Tangerine or White
- Each compartment will hold 1 quad depth tray if required (priced separately, see pages 48-51) – inner dimensions W316 x D450 x H310mm
- Supplied with a set of plastic feet & connecting pins
- Maximum recommended stacking height 2 metres

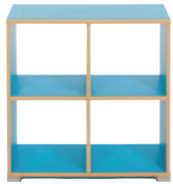

A. 4 cube (2 x 2)

- W700 x D453 x H774mm

Y17200

£258.00



B. 6 cube (2 x 3)

- W1030 x D453 x H774mm

Y17202

£314.00

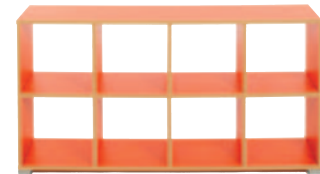

C. 8 cube (2 x 4)

- W1358 x D453 x H774mm

Y17206

£371.00

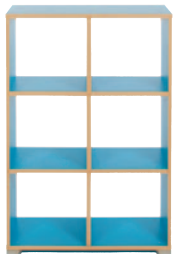

D. 6 cube (3 x 2)

- W700 x D453 x H1002mm

Y17204

£314.00



E. 9 cube (3 x 3)

- W1030 x D453 x H1002mm

Y17208

£385.00

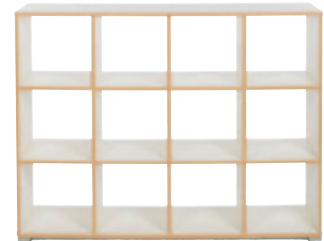

F. 12 cube (3 x 4)

- W1358 x D453 x H1002mm

Y17210

£464.00

Storage Cupboards

- Low level cupboards
- Vertical divider creates 2 compartments with 1 adjustable shelf each side
- Solid back, doors with silver handles
- Supplied with a set of plastic feet & connecting pins
- Use with room dividers to give extra height & storage space
- Maximum recommended stacking height 2 metres
- Can be used as base units for the room dividers on page 74

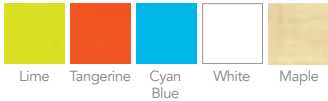

A. Cupboard 700mm Wide

Y17212 W700 x D453 x H500mm £356.00
 use with A & D



B. Cupboard 1030mm Wide

Y17214 W1030 x D453 x H500mm £429.00
 use with B & E



C. Cupboard 1358mm Wide

Y17216 W1358 x D453 x H500mm £479.00
 use with C & F

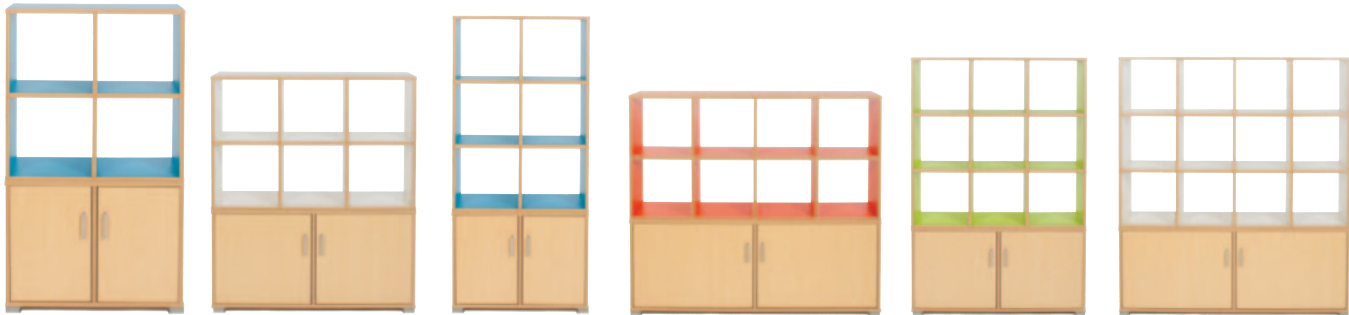

Combine room dividers with complementary storage cupboards (see previous page)



Grasmere Curve Book Storage System

- Premium range made from high quality 18mm MFC in a choice of board finishes with cream back boards
- Choice of either single sided bookcases in 2 heights, or double sided mobile units in 3 different heights
- Other board finishes available - please ask for pricing and details

A. Grasmere straight bookcase

- Single sided
- Depth 306mm

		Shelves		
Y200600	H900 x W1000mm	2	each	£370.50
Y200604	H900 x W600mm	2	each	£331.00

B. Grasmere straight bookcase

- Double sided
- Depth 576mm

		Shelves		
Y200610	H900 x W1000mm	2	each	£517.00
Y200612	H1200 x W1000mm	2	each	£670.50
Y200614	H1500 x W1000mm	3	each	£789.50
Y200616	H900 x W600mm	2	each	£430.00
Y200618	H1200 x W600mm	2	each	£591.00
Y200620	H1500 x W600mm	3	each	£663.00

C. Grasmere curved bookcase

- Single sided
- Choice of concave (curves inwards) or convex (curves outwards)
- Maximum depth 835mm, width 1180mm

		Shelves		
Y200630	Convex H900mm	2	each	£555.00
Y200632	Concave H900mm	2	each	£555.00
Y200634	Convex H1200mm	2	each	£658.00
Y200636	Concave H1200mm	2	each	£658.00

D. Grasmere curved bookcase

- Double sided
- Maximum depth 1115mm x width 1575mm

		Shelves		
Y200640	Convex H900mm	2	each	£719.50
Y200642	Convex H1200mm	2	each	£936.50
Y200644	Convex H1500mm	3	each	£1245.00
Y200646	Concave H900mm	2	each	£719.50
Y200648	Concave H1200mm	2	each	£936.50
Y200650	Concave H1500mm	3	each	£1245.00

Page Link - see pages

For waterfall units... 210-211



Please ask for pricing on special colours



Concave

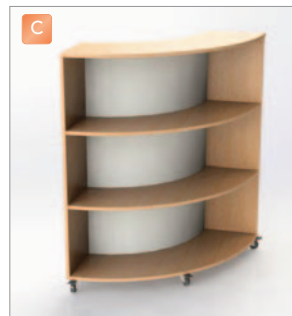

Convex

Wood & colour finishes may not be representative of actual colours - please ask for a sample



Beech Oak Maple Grey Red Yellow Green Blue White

Bag Storage

- New range of static classroom bag storage units in choice of Beech-BE, Maple-MP, Grey-GY, Oak-OK or White-WH finish
- Supplied fully assembled, ready for use



A. Premium Bag Storage

- Ideal for storing school bags, PE kits, and everything in between
- Internal compartment sizes H300 x W400 x D460mm
- A choice of 5 colour finishes: Beech, Grey, Maple, Oak, White

	No. Compartments	H x W x Dmm	
Y200710	4	1390 x 440 x 460	£194.94
Y200712	8	1390 x 858 x 460	£299.67
Y200714	12	1390 x 1276 x 460	£417.42



C. 8 & 16 compartment units

- 8 compartment: W1222 x D475 x H1018mm
- 16 compartment: W1222 x D475 x H1818mm

Y200700	8 Compartment	£332.00
Y200702	16 Compartment	£421.00

Carcass Colours

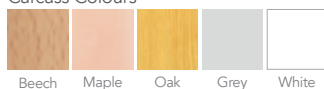

Beech Maple Oak Grey White



B. Uniform Tray Storage Units

- Solid and durable and available with doors and locks for extra security
- Choice of 5 colour finishes: Beech, Grey, Maple, Oak, White
- Comes complete with trays in your choice of colours

	No. Trays	H x W x Dmm	
Y200720	6	1674 x 356 x 460	£346.40
Y200721	6 With Doors	1674 x 356 x 480	£419.66
Y200723	12	1674 x 690 x 460	£523.96
Y200724	12 With Doors	1674 x 690 x 480	£615.54
Y200726	18	1674 x 1024 x 460	£709.45
Y200727	18 With Doors	1674 x 1024 x 480	£819.27



D. 8 & 16 compartment benches

- Choice of 8 frame colours as below
- 8 compartment D350 x H515 x W1200mm
- 16 compartment D350 x H515 x W1500mm

Y320350	8 Compartment	£192.00
Y320352	16 Compartment	£362.00

Frame Colours for item D



Red Apple Green Cyan Tangerine Cool Blue Lime Grey Yellow

Premium Tray Storage Furniture



Quadrant Tub Storage Range



Kinderbox Open Book Storage



Bag Storage



Colorstore™ premium tray storage furniture is available in a huge range of colours sizes and tray combinations. Please ask for details and prices.

Art Room Storage



- Trays supplied FOC with all units, See pages 48-51 for colour and size options
- Please specify Beech (BE) or Maple (MP) carcass.
- Ask our sales office for details on other finishes available



Standard carcass colours



Maple Beech

A. 6 bay kinderbox art unit

- With 12 single or 6 double depth trays
- W1022 x D453 x H600mm

Y15258	Beech	£362.00
Y203280	Maple	£362.00

B. 4 bay kinderbox art unit

- With 8 single or 4 double depth trays
- W690 x D453 x H600mm

Y15256	Beech	£251.00
Y203282	Maple	£251.00

C. Combination shelf unit

- With 8 single or 4 double depth trays
- W700 x D453 x H789mm

Y16014	Beech	£244.00
Y203284	Maple	£244.00

D. Combination shelf unit

- With 12 single or 6 double depth trays
- W1030 x D453 x H789mm

Y16012	Beech	£319.00
Y203286	Maple	£319.00



A



B



h4
height
789mm

C



h4
height
789mm

D



A. 6 bay kinderbox with 18 single trays

- W1026 x D457 x H792
- Comes with castors

203290	Beech	£235.00
203292	Maple	£235.00



B. 8 bay kinderbox with 16 single trays

- W1354 x D457 x H619
- Comes with castors

203294	Beech	£269.00
203296	Maple	£269.00



Art Room Storage



- Please specify Beech (BE) or Maple (MP) carcass.
Ask our sales office for details on other finishes available



A. Static plan chest

- With beech or coloured drawers
- 6 drawers designed to hold A1 paper
- W1015 x D750 x H780mm

Y16016	Beech/Maple Drawers	£536.00
--------	---------------------	---------



B. Mobile paper storage

- 4 sliding drawers designed to hold A1 paper
- Open front: W1006 x D754 x H703mm
- With Doors: W1006 x D779 x H703mm

Y16018	Open Front	£432.00
Y16020	With Locking Doors	£547.00

Storage Trolleys



- Mobile metal frame trolleys supplied complete with plastic trays
- Items A & B come in a choice of frame colours - Red, Green, Cyan, Tangerine, Blue, Lime, Light Grey, Yellow and White - please specify



A. Sports trolley

- Perfect for storing PE equipment
- 6 Jumbo Trays
- W1050 x D430 x H1480mm
- Frame colour options listed above

Y15147

£629.00



B. Art trolley/snack trolley

- Ideal for storing art & craft resources or brektime snacks or fresh fruit.
- 8 double depth trays and lids
- W708 x D430 x H943mm
- Frame colour options listed above

YEYEF1800

£406.00



Option 1



Option 2



Option 3



5 year guarantee



Terrain Wheels



5 Year Warranty



Easy Self Assembly

C. Grattnell's Transporting trolley

- Metal trolley with large rubber wheels that can hold a range of Grattnell's tray combinations
- Strap holds trays in place
- Trolley will hold 2 Jumbo trays, or equivalent
- Dimensions H1170 x W560 x D760mm
- Please state tray option & colour required

Y203398

£290.62



Easy Self Assembly

D. Arts & Craft Storage Trolley

- A mobile storage trolley supplied with one large V-shaped wire basket,
- 3 small wire baskets & 3 shallow gratnells trays.
- Made from sturdy metal
- Easy to move round a classroom
- Dimensions: L1260 x W450 x H850mm

Y203710

£202.80



Easy Self Assembly

E. General Storage System

- Mobile Storage Trolley supplied with a large V-shaped wire basket and a range of plastic deep and shallow.
- Made from sturdy metal
- Easy to move round a classroom
- Dimensions: L1260 x W450 x H850mm

Y203711

£238.60



Easy Self Assembly

F. Music Storage Trolley

- An ideal music storage trolley with two large V-shaped wire baskets and three shallow gratnells trays.
- Made from sturdy metal
- Easy to move round a classroom
- Dimensions: L1260 x W450 x H 850mm

Y203712

£202.80

New
Product

A

**A. Heavy duty 36 lunchbox trolley**

- 3 Beech MFC Shelves
- Dimensions: D350 x W1300 x H1070mm
- Please specify frame colour

203713	Beech	383.35
203714	Maple	383.35

New
Product

B

**B. Heavy duty 42 lunchbox trolley**

- 3 Beech MFC Shelves
- Dimensions: D600 x W680 x H1100mm
- Please specify frame colour

203715	Beech	386.31
203716	Maple	406.65

New
Product

C

**C. Heavy duty 72 lunchbox trolley**

- 3 Maple MFC Shelves
- Dimensions: D600 x W1300 x H1070mm
- Please specify frame colour

203717	Beech	525.37
203718	Maple	525.37

Frame Colours

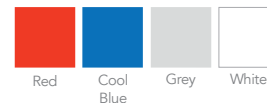

Red

Cool
Blue

Grey

White

Storage Trolleys

Extra Value

- High quality, heavy duty mobile storage trolleys
- All have robust, laminate MDF panels supported by a strong EPC scratch resistant coated metal frame
- Lockable heavy duty castors for easy mobility
- Tested to BS5873 for strength & stability standards
- Supplied flat-packed for easy self-assembly



Page Link - see pages
More metal trolleys... **82-85**



A. 60 lunchbox trolley

- Holds 60 lunchboxes
- Double unit

YFN0604 W1215 x D740 x H1160mm **£440.74**



B. Tech2 cloakroom trolley

- 15 double coat/bag hooks per side to hold 30 coats
- Perspex name card-holders for easy location & identification hooks
- Large storage base ideal for shoes & bags with centre divide & lip
- Shelf depth each side 260mm
- Label holder on end panel to identify class etc.

YFN0602 W1610 x D740 x H1140mm **£441.09**

Metal Storage Trolleys

- Robust steel frame trolleys designed to withstand the daily rigours of a busy school environment
- Meet BS5873 safety tests for strength, stability and safety
- Heavy duty castors, 2 lockable
- Blue & silver powder coated (EPC) scratch resistant finish for superior strength
- Supplied flat-packed for easy self assembly



5 Year Warranty



C. Lunchbox trolley

- Large: W1025 x D500 x H900mm
- Small: W610 x D500 x H900mm
- Frame colour options shown on previous page

YEF8113 Small **£299.00**
YEF8110 Large **£379.00**



D. Lunchbox trolley

- High capacity trolley with 3 large shelves
- Holds up to 60 lunchboxes

Y200802 W1003 x D610 x H1115mm **£356.37**



E. Cloakroom trolley

- Large base storage shelf, ideal for shoes & bags with a centre divide
- 15 double coat/bag hooks per side store 30 coats

Y200800 W1200 x D604 x H1115mm **£328.14**

CalStor Flexible Storage

- Premium range of tray storage & shelving units
- Robust steel frame with modern styling
- Silver frame
- Fill with any selection of tray colours (see pages 48-51 for choice)
- Units can either sit on static feet, or mobile braked castors – supplied with both options
- All castors are 75mm
- StopSafe © tray runners prevent trays falling out
- Sizes: Double column units H1065 x W730 x D455mm; Triple column units H1065 x W1065 x D455mm



Space-saving



5 year guarantee



Easy Self Assembly



A. Gratnell's 16 shallow tray unit

- Includes 16 shallow trays

Y203421

£434.92



B. Gratnell's 8 deep tray unit

- Includes 8 deep trays

Y203423

£388.15



C. Gratnell's 8 shallow & 4 deep tray unit

- Includes 8 shallow and 4 deep trays

203452

£415.27



C. Gratnell's Jumbo tray unit

- Includes 4 jumbo trays

Y203425

£341.38



D. Gratnell's 24 shallow tray unit

- Includes 24 shallow trays

Y203427

£537.81



E. Gratnell's 12 deep tray unit

- Includes 12 deep trays

Y203429

£541.38

CalStor Library Storage

- Premium range of tray storage & shelving units
- Robust steel frame with modern styling
- Silver frame
- Units can either sit on static feet, or mobile braked castors – supplied with both options
- All castors are 75mm
- StopSafe © tray runners prevent trays falling out



5 year guarantee



Easy Self Assembly



A. Gratnell's 16 shallow & 4 deep tray unit

- Includes 16 shallow and 4 deep trays



B. Gratnell's Flat Shelf Unit

- 3 wide shelves supported on flat crossbars
- H1065 x W1065 x D455



C. Gratnell's Angled Shelf Unit

- 3 angled display shelves support on tilted crossbars
- H1065 x W1065 x D455

203456

£519.09

203469

£416.22

203473

£420.89

CalStor Classroom Trolleys

- Ergonomic tubular steel frame trolleys with loop handles, 75mm castors and foot activated brake
- Strong wire storage baskets
- Suitable for indoor & outdoor use
- Supplied flat-packed for easy self-assembly. Please ask for details of our assembly service if needed



Easy Self Assembly



D. Gratnell's ~Lunchbox trolley

- Can accommodate up to 30 x lunchboxes
- H1065 x W1065 x D455



E. Gratnell's ~Cloakroom trolley

- 32 x double coat hooks
- Bottom wire basket for wellies or lunchboxes
- H1175 x W1065 x D455

Y203482 Silver Frame

£539.82

Y203486 Silver Frame

£600.14

HandiStor Mobile & Static Metal Storage

- The HandiStor tray storage range is available as a mobile trolley, or static frame
- Manufactured with powder coated steel frame with MFC tops
- Supplied c/w trays as shown. Select your colours from the range shown on page 48
- Choice of single column, double column or triple column widths
- Supplied fully assembled

Frame Colours

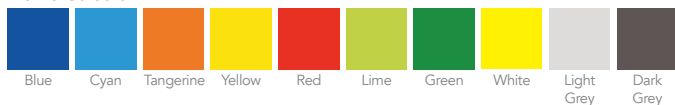

5 Year
Warranty

MFC
Tops



A. 6 Single Tray Trolley

- W390 x D430 x H674mm

Y203520

£197.00



B. 12 Single Tray Trolley

- W710 x D430 x H674mm

Y20321

£282.00



C. 18 Single Tray Trolley

- W1050 x D430 x H674mm

Y203522

£368.00



D. 24 Single Tray Trolley

- W1050 x D430 x H850mm

Y203523

£515.00



E. 68 Single Tray Frame

- W390 x D430 x H850mm

Y203524

£289.00



F. 16 Single Tray Frame

- W710 x D430 x H850mm

Y203525

£304.00



G. 24 Single Tray Frame

- W1050 x D430 x H850mm

Y203526

£435.00

A. 45 Single Tray Frame

Y203528	W1050 x D430 x H1510mm	£739.00
---------	------------------------	---------



B. 38 Single Tray Frame

Y203529	W710 x D430 x H1835mm	£600.00
---------	-----------------------	---------



C. 57 Single Tray Frame

Y203530	W1050 x D430 x H1835mm	£869.00
---------	------------------------	---------

PREP-ROOM, FOOD, SCIENCE & TECHNOLOGY STORAGE INSTALLATIONS

Please call for a free consultation for your larger projects – full Science Technician store rooms, integrated bench storage etc.

Using the wide range of accessories & fitments will enable you to customise your installation for the maximum benefit.

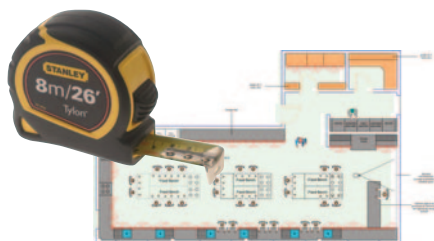

TecniStor Static Metal Tray Storage



- Static storage systems ideally suited for Science Technician or D&T storage, Print Rooms, Food Tech, or any other areas needing the flexibility of multiple sized compartments, easy retrieval of products or parts, along with the maximising of storage height
- Accommodates all depths of trays – mix available colours to fill the unit as shown
- Options of all tray storage, or a mix of plastic trays & open steel shelves
- Static construction with adjustable feet for stability
- Supplied flat-packed for easy self-assembly
- Full installation service available – please ask for a free site assessment and complete service package quotation
- Dimensions: All units 420mm deep. Single W370, Double w710, Treble W1055mm

Frame Colours

Please specify when ordering



Grey Silver



Easy Self Assembly



5 year
guarantee



A. Gratnell's 51 shallow trays

- H1850

Y203600 £941.40



B. Gratnell's 9 deep & 18 shallow trays

- H1850
- Includes 6 single shelves

Y203602 £834.91



C. Gratnell's 3 jumbo, 6 deep & 18 shallow trays

- H1850
- Includes 12 single shelves

Y203604 £801.65



D. Gratnell's 30 shallow trays

- H1850
- Includes 6 single shelves

Y203606 £832.75



E. Gratnell's 27 deep Trays

- H1850mm

Y203607 £763.21



F. Gratnell's Open 4 shelf unit

- H1850mm

Y203608 £462.55



G. Gratnell's Open 6 shelf unit

- H1850mm

Y203610 £561.47



H. Gratnell's Shelf/drawer unit

- H1850mm
- 2 wide shelves & 6 wooden drawers

Y203612 £1060.53

TecniStor Static Metal Tray Storage



A. Gratnell's 34 shallow trays

- H1850mm

Y203614 £683.65



B. Gratnell's 2 deep & 18 shallow tray

- H1850mm
- Includes 4 single shelves

Y203616 £641.73



C. Gratnell's Open 4 shelf unit

- H1850mm

Y203618 £381.34



D. Gratnell's 39 shallow trays

- H1500mm

Y203620 £778.48



E. Gratnell's 36 shallow tray

- H1500mm

Y203622 £746.61



F. Gratnell's 3 jumbo, 6 deep, 15 shallow

- H1500mm

Y203624 £663.05



5 year guarantee



Page Link - see page

For trays 48-51



Page Link - see page

Metal Tray Cupboards 367



Frame Colours



Grey Silver

TecniStor Mobile Metal Trolleys

- Complete trolley sets with metal top built for demanding Science & Technical Environments
- Robust design with industrial style castors and steel top
- Choose bench height 850mm or under bench size 725mm
- Supplied complete with plastic trays – select from the range on page 50
- Optional steel shelf trolleys suit larger items
- Range of accessories available to fit – please ask for details
- Static frames also available - please enquire for details



5 year
guarantee



Frame Colours
Please specify when ordering



Grey Silver



Durable
Metal Tops



Easy Self Assembly



A. Gratnell's 3 column tray unit

- W1055 x D420mm

Y203640	H850mm, 18 Tray	£490.39
Y203642	H725mm, 15 Tray	£455.86



B. Gratnell's 2 column tray unit

- W710 x D420mm

Y203644	H850mm, 12 Tray	£412.51
Y203646	H725mm, 10 Tray	£391.23

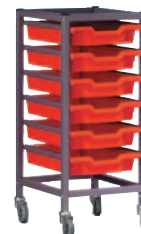

C. Gratnell's 1 column tray unit

- W370 x D420mm

Y203648	H850mm, 6 Tray	£245.63
Y203650	H735mm, 5 Tray	£234.98

TecniStor Static Low Storage Units

- Static units ideal for use under existing benching
- Sold without metal top – this can be ordered separately.
- Supplied c/w Gratnells trays – select any mix from page 50
- Also available as steel shelf units – ideal for larger items



D. Gratnell's 3 column static tray unit

- W1055 x D420mm

Y203652	H825mm, 21 Tray	£433.41
Y203654	H725mm, 18 Tray	£390.35



E. Gratnell's 2 column static tray unit

- W710 x D420mm

Y203656	H825mm, 14 Tray	£382.02
Y203658	H725mm, 12 Tray	£309.16

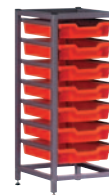

F. Gratnell's 1 column static tray unit

- W370 x D420mm

Y203660	H825mm, 7 Tray	£185.11
---------	----------------	---------

Multiwall



- MultiWall creates extensive space-efficient resource storage situated at the front of the classroom to ensure that teaching staff have resources available whenever they teach
- MultiWall includes a variety of lower storage options, and upper units can include interactive whiteboards or projection screens, sliding drywipe panels or pinboards with adjustable shelving behind
- Modular system allows for bespoke configurations to your specific needs
- Large range of colour finish options and sizes to suit the available space
- Suits and facilitates multiple use classrooms



Units available in:

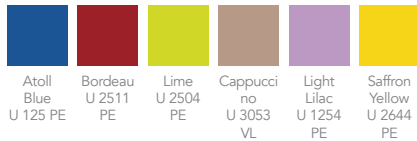
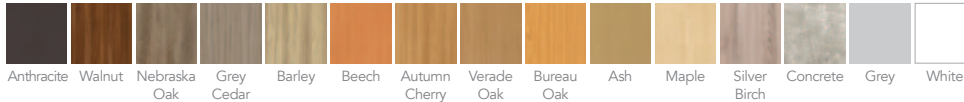

Please phone for details and prices

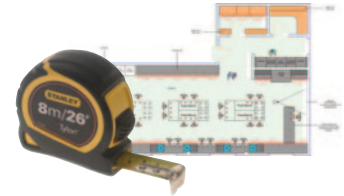

Teaching Wall

This modular storage solution offers infinite design opportunities for classrooms, offices, boardrooms and community buildings. It has the option of an integrated touchscreen TV or an interactive whiteboard and at the same time it provides multiple storage options.

Teaching Walls can make excellent use of underutilised space at the front of every lecture hall or classroom.

Each unit can feature tray or cupboard storage, shelving, interactive whiteboards, desks, pinboards, or standard whiteboards to create a flexible resource.

We can incorporate charging bays for laptops/tablets and conceal any cables within the design. The combinations and colour options are almost limitless.

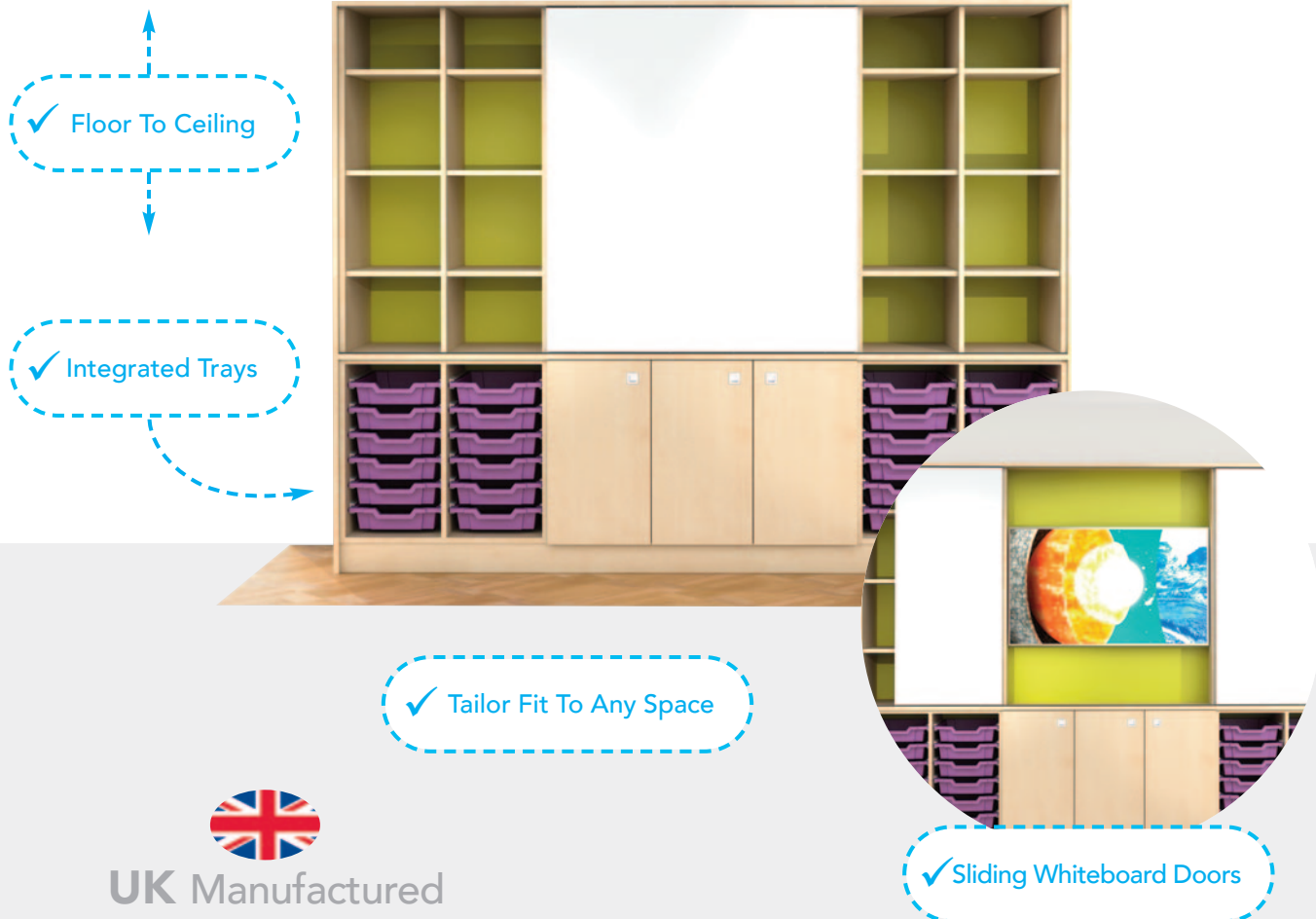

UK Manufactured



Many Colours & Materials available to match your exact requirements

✓ Endless Modular Add-Ons

Call for a
FREE CONSULTATION





3 work surface heights available to suit all age ranges

classtor™

the modular classroom storage system

- This modular system offers a range of storage solutions for the classroom - making the most of your space
- 3 work surface heights - infant, junior and senior
- A wide range of units enable suitable storage of books, art paper, art supplies and national curriculum materials to keep your classroom organised, neat and tidy
- Available in an easy to clean, modern look with a wide range of wood finishes and worktop designs
- We offer a space planning service to work with you to get the most from your classroom and storage

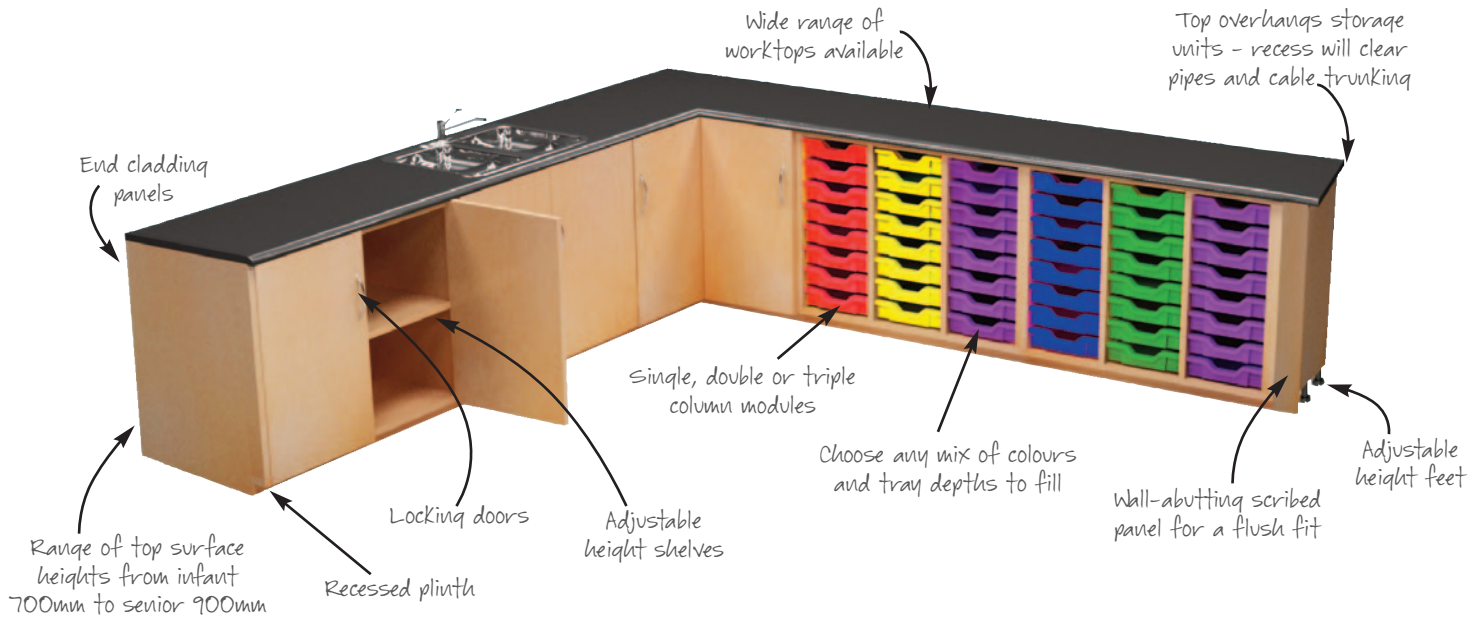

Survey & Space
Planning Service

Image Ref. 770200

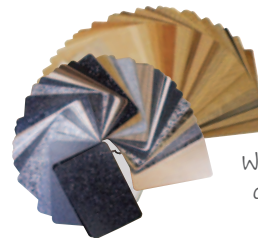

Wide range of worktop
colours and finishes

classtor™
 the modular classroom storage system

Classtore offers a wide range of materials and finishes in all its configurations. Whether you want solid wood, laminate or even trespa finishes, we can help.



A. 8 Bay Book Store



B. Corner Unit



C. Cupboard Unit



D. 8 Drawer Unit



E. 24 Tray Storage Unit



F. 8 Shelf Paper Storage



G. 8 Drawer Paper Storage



H. 2 Drawer Side Filer



I. Angled Book Shelf



J. Sink Unit



K. 25 Pigeon Holes



L. 2 Shelf Unit





Are you stimulating those young minds?

Strong, attractive furniture with a friendly & fulfilling approach promotes creativity from day one!

Early Years

Early Years Zones	98-99
Creative! Role Play Panels	100-101
Creative! Role Play Furniture	102
Creative! Storage Solutions	103-108,110
Creative! Tables & Chairs	109
Creative! Dens	111
Soft Seating	112-115
Cushions & Mats	116-119
Sand & Water Play	120-121
Easels	122
Play Corners & Modules	123-124
Natural Beech Storage Units	125-126
Tables & Chairs	127-128
Outdoor Play Furniture	129

Early Years

Here we present a range of products that provide a safe, comfortable and colourful environment, where children enjoy a world they recognise and where their imaginations are inspired.

We can provide children with somewhere to sit and learn alone and spaces to be taught in groups.

Our products provide children stimulation through use and display. Our storage facilities ensure that their daily world is left neat and tidy.

Cloakroom and lunch storage facilities teach young minds to guard and value their personal space and possessions.



Zone includes the following units:

- Clear view low browser
- Mobile clear view browser
- Mobile tall book display
- Double sided book display unit
- Tall den cave set - taupe roof
- Low level 90 degree corner unit

**A. Cosy reading zone area**

A tranquil setting for children to read and relax, or enjoy quiet play. The den featured in this zone can be used to create an area that you can decorate to suit a theme or activity. Each unit is manufactured in the UK and made from scratch-resistant maple melamine with solid beech features which are durable, hard-wearing and easy to clean.

- 3.35m x 2.31m

YPT507

set £2,585.00

Zone includes the following units:

- Double sided creative unit
- Tall 90 degree corner unit
- Double-sided whiteboard easel plus storage trolley
- Drying rack unit with 10 racks
- Open storage unit
- Shelf unit with display & mirror back with 6 clear tubs
- Double sided whiteboard easel

**B. Creativity zone area**

Designed to allow maximum storage for art & craft materials, this zone also creates an environment which encourages expression and imagination, and combines functionality with inspiration. Units have a maple melamine surface which is waterproof and easy to wipe-clean

- 3.51m x 2.50m
- Supplied with clear tubs

YPT597

set £2,995.00

Zone includes the following units:

- Mini storage trug
- Low level 90 degree corner unit
- Low Block Play Unit
- Hollow block storage unit with back
- Light box trolley with mirror surround
- Investigative play table with 4 clear tubs
- Low level storage bench & 3 baskets
- Treadplate mat
- Under 2's multi-use building
- Mobile clear view browser with 3 baskets
- Low level den cave set with baskets - taupe roof

**C. STEM investigation zone**

Presents opportunities for children to explore, build, count, problem solve and investigate, with furniture and resources, which support these skills. The investigative play table is a resource for loose parts, small world and transient art resources, whilst the block units can be used to create a variety of structures. Each unit is manufactured in the UK and made from scratch-resistant maple melamine with solid beech features which are durable, hard-wearing and easy to clean.

- 4.34m x 5.02m

YPT153

set £6,495.00

**D. Double sided 4 station with tall storage trolley**

Easel and tall level storage trolley combination. Features a double sided 4 station whiteboard easel with 16 paint pots, a storage trolley with 4 storage tubs & space for art supplies

- Made from premium grade maple melamine
- Easel has whiteboard surface on both sides
- Lockable castors are anti-scratch and low-noise
- Sturdy and durable construction
- Easy-clean surfaces
- W1200 x D600 x H1210mm
- Fully assembled (easel is attached to trolley using supplied Allen key)
- 10 year guarantee

YPT1069

each £895.00

All items on this page

**Lifetime
Warranty**

A. Light box with mirror surround

- This mirror surround and light box combination helps to create a focused space for sensory development and play.
- The mirror is easy to remove as required to accommodate group play. Complete with 3 x shallow clear tubs and 3 x deep clear tubs for housing resources.
- The light box is mains operated with LED bulbs which can be replaced as required
- Manufactured from easy-clean and durable maple melamine and delivered fully assembled
- Removable mirror surround and panel for changing bulbs
- Mains operated
- W900 x D400 x H870mm

YPT131	each	£695.00
--------	------	---------



B. Continuous provision trolley

- The perfect place to store and organise resources for mark making, collage and more! This sturdy mobile trolley comes complete with 5 shallow trays and 12 handy mini clear tubs.
- In addition there are 6 storage pots which are ideal for storing glue sticks, stamps, scissors etc. and a roll holder for lining paper and ribbons.
- Made from easy-clean and durable maple melamine and delivered fully assembled
- W900 x D400 x H800mm

YPT123	each	£639.00
--------	------	---------



C. Pack away cabinet

This folding and locking storage unit is the perfect space-saving solution for pack away settings and can be used fully opened to divide space and create a zoned area.

- Made from premium grade maple melamine and delivered fully assembled
- Lockable castors are anti-scratch and low-noise
- Sturdy and durable construction
- Easy-clean surfaces
- Closed: W920 x D750 x H900mm
- Open (straight line): W1835 x D375 x H900mm
- Open (in corner): W1280 x D1280 x H900mm

YPT1057	With Clear Trays	each	£965.00
---------	------------------	------	---------

YPT1058	With Baskets	each	£1295.00
---------	--------------	------	----------



D. Investigate play table with baskets

- A unique storage solution and play surface combination which offers maximum versatility for sorting and organising maths, loose parts, small world and transient art resources.
- The play table includes 4 shallow baskets and a movable sorting tray, which can be positioned as required on the table surface.
- When not in use, the sorting tray has its own storage cubby on the underside of the table.
- Made from high quality birch plywood
- Includes 4 shallow baskets
- W1160 x D650 x H465mm

YPT143	each	£695.00
--------	------	---------



Creative! Natural Role Play Panels

- Made from maple melamine with a solid beech timber frame and tough, child safe, clear lacquer finish
- Easy Clean Surfaces
- Each panel: W780 x D40 x H1200mm (supplied with 2 joining blocks)
- Lockable joining blocks allow panels to join to each other at seven different angles, enabling you to create any shape to meet your needs and make the most of the available space
- 5 year warranty



A. Display Panel

- Double-sided sound reducing Velcro display board

YCRT0320

£229.00



B. Double Door Panel

- Double doors with cut-out detail

YCRT0321

£229.00



C. Maple Panel

- Plain panel for dividing space

YCRT0322

£229.00



D. Tall Archway Panel

- Open archway for easy access
- H1310mm

YCRT0323

£229.00



E. Whiteboard Panel

- Double-sided whiteboard

YCRT0324

£229.00



F. Window Panel

- Window panel with washable curtains

YCRT0325

£229.00



G. Maple Counter Panel

- Two shelves, awning and counter

YCRT0326

£229.00



H. Mirror Panel

- Single safety mirror, maple back

YCRT0327

£229.00



I. Chalkboard Panel

- Double-sided chalkboard

YCRT0328

£229.00



Creative! Panel Connectors

For complete flexibility when setting out your room, our Panel Connectors allow you to join your panels (at any angle) to walls and other Creative! furniture. This unique system allows you to create secure room divisions, and use a combination of storage units and panels, to create defined areas for role play, crafts, construction, reading and so much more.



J. Connectors - Set of 2

- Includes two brackets to connect one panel to furniture or a wall at any angle
- Fits all Play Panels

YCRT0329

£69.00

Creative! Coloured Role Play Panels

- Creative! colourful role play panels which can be used alongside the maple panel range to create themes or divide space
- Made from solid beech timber and birch plywood with a tough, child safe, clear lacquer finish
- Lockable joining blocks allow panels to join to each other at seven different angles, enabling you to create any shape to meet your needs
- Each panel: W780 x D40 x H1200mm (supplied with 2 joining blocks)



A. Theatre Panel

- Chalkboard and fabric curtains

YCRT0337

£229.00



B. Bank/Post Office Panel

- Counter, shelf, ATM and cut-outs

YCRT0336

£229.00



C. Counter Panel

- Two shelves, awning and counter

YCRT0332

£229.00



D. Window Panel

- Flower detail and fabric curtains

YCRT0333

£229.00



E. No.10 Door Panel

- Door, letterbox, and engraved detail

YCRT0335

£229.00



F. Health Centre Panel

- Counter, window chalkboard and shelf

YCRT0338

£229.00



Mix & Match panels on these pages combine to give endless possibilities for creative play





Safety Feature – anti finger trap hinges on all units

Creative! Kitchen Role Play Units

- Anti finger-trap hinges - ideal for group play
- Maple wood grain finish
- 600mm worktop height - perfect for 3 years+
- Hard-wearing, scratch resistant, wipe clean melamine surfaces
- Rotating dials
- 5 minute assembly
- Kitchen Set: W1600 x D360 x H830mm
- Units: W400 x D360 x H630mm
(Microwave: W400 x D260 x H200mm)



A

A. Natural kitchen set

- Specially designed for ages 3+
- Made from birch plywood, with rotating dials & safety perspex windows for realistic play
- Rounded corners & safety edges and anti-finger trap hinges
- Set includes: cooker, sink, washer, fridge
- Kitchen Units: W350 x D320 x H550mm

YPT844	£835.00
--------	---------

B



C



D



E



F



B. Washing machine

YCRT0344	Red	£219.00
----------	-----	---------

C. Oven/hob unit

YCRT0345	Maple	£219.00
----------	-------	---------

D. Fridge

YCRT0341	Maple	£219.00
----------	-------	---------

E. Sink/dishwasher unit

YCRT0339	Maple	£219.00
----------	-------	---------

F. Microwave

YCRT0347	Maple	£178.00
----------	-------	---------

G. Complete Kitchen Set

YCRTKSET-M	Maple	£999.00
------------	-------	---------

G



Creative! Low Level Storage Units

- The perfect height for creating an enabling environment which encourages independence and exploratory play.



A. Static low level unit

- Resources accessible from both sides
- Anti-scratch, low noise, lockable castors
- Sturdy construction
- W900 x D400 x H430mm
- Top shelf: H320mm

YCRT0101 With Clear Tubs £385.00

YCRT0102 With Baskets £485.00



B. Mobile low level unit

- Resources accessible from both sides
- Sturdy construction
- W900 x D400 x H430mm
- Top shelf: H320mm

YCRT0103 With Tubs £385.00

YCRT0104 With Baskets £429.00



C. Low mirror play unit

- Removable safety mirror surface
- Top ledges create enclosed play area
- Resources accessible from both sides
- W900 x D400 x H430mm
- Top shelf: H320mm

YCRT0105 With Tubs £495.00

YCRT0106 With Baskets £545.00



Sliding wooden dividers

D. Clear view low browser

- Two movable dividers allow you to condense or expand the storage compartments
- Super tough clear sides
- Rounded solid beech grab rails (H310mm)
- W900 x D400 x H360mm

YCRT0107 £489.00



E. Kinder box

- Storage unit with 4 compartments
- Compartments 288 x 260mm
- Anti-scratch, low noise, lockable castors
- W615 x D595 x H350mm

YCRT0108 £249.00



F. Low level 90° corner unit

- Join two units in a smooth curve
- Use 4 corners to create an island
- Ideal for safe free-flow areas
- W500 x D500 x H430mm
- Top shelf: H320mm

YCRT0110 £389.00



G. Easy access storage unit

- Two fixed dividers
- Large safety mirror side
- Ideal for storing blocks for easy access
- W900 x D400 x H430mm

YCRT0109 £379.00



Removable safety surface mirror

Creative! Low Level Display & Store Units

- These low level display units with add-ons, perfectly combine storage with a useful divider feature
- The display and whiteboard dividers are ideal for displaying work and information, whilst the mirror divider is perfect for sensory use and play
- All divider panels are double-sided.



A. Low display storage unit

- Removable double-sided Velcro display board
- Resources accessible from both sides
- Anti-scratch, low noise, lockable castors
- W900 x D400 x H800mm - Top shelf: H320mm

YCRT0111	With Castors & 3 clear tubs	£498.00
YCRT0112	With Castors & baskets	£629.00
YCRT0113	Without Castors & 3 clear tubs	£498.00
YCRT0114	Without Castors & baskets	£545.00



B. Low mirror storage unit

- Removable double-sided safety mirror
- Resources accessible from both sides
- Anti-scratch, low noise, lockable castors
- W900 x D400 x H800mm - Top shelf: H320mm

YCRT0115	With Castors & 3 clear tubs	£535.00
YCRT0116	With Castors & baskets	£560.00
YCRT0117	Without Castors & 3 clear tubs	£525.00
YCRT0118	Without Castors & baskets	£549.00



C. Low magnetic storage unit

- Removable double-sided white enamelled steel for use with magnets
- Resources accessible from both sides
- Anti-scratch, low noise, lockable castors
- W900 x D400 x H800mm - Top shelf: H320mm

YCRT0119	With Castors & 3 clear tubs	£595.00
YCRT0120	With Castors & baskets	£595.00
YCRT0121	Without Castors & 3 clear tubs	£539.00
YCRT0122	Without Castors & baskets	£595.00

Creative! Medium Height Open Storage Units

From practical storage solutions to play themed units, Creative! is a comprehensive and coordinated range that will suit all environments and budgets. These medium height storage units represent excellent quality combined with flexibility.



D. Sweeping 45° storage unit

- Storage unit with 3 shelves
- Resources accessible from both sides
- No dividers for added versatility
- Use two or more to make a curve or 'S' shape
- W900 x D455 x H660mm - Top shelf: H560mm

YCRT0123	£369.00
----------	---------



E. Open storage unit

- Resources accessible from both sides
- No dividers for added versatility
- W900 x D400 x H660mm
- Top shelf: H560mm

YCRT0124	£429.00
----------	---------



F. 90° corner unit

- Join two tall units in a smooth curve
- Use four corners to create an island
- W500 x D500 x H660mm
- Top shelf: H560mm

YCRT0125	£398.00
----------	---------

Creative! Medium Height Display & Store Units



Mirror Back



Rear View

A. Storage unit with display/mirror back

- Choice of tubs or baskets
- Removable mirror attaches to Velcro on reverse
- Mobile unit has anti-scratch, low noise, lockable castors
- W900 x D400 x H660mm - Top shelf: H560mm

YCRT0129	Mobile, with 6 Clear Tubs	£445.00
YCRT0130	Mobile, with 6 baskets	£595.00
YCRT0137	Static with 6 Clear Tubs	£495.00
YCRT0138	Static with 6 baskets	£575.00

B. Storage unit with display top panel

- Velcro display surface on reverse
- Removable mirror attaches to Velcro on reverse
- Top add-ons can be easily removed and interchanged
- Anti-scratch, low noise, lockable castors
- W900 x D400 x H1040mm
- Top shelf: H560mm

YCRT0134	With 6 Clear Tubs	£729.00
YCRT0135	With 6 baskets	POA

**C. Lockable cupboard with display/mirror back**

- 2 door, lockable storage cupboard
- 3 shelves of which 2 are height adjustable
- Velcro display surface on reverse
- Removable mirror attaches to Velcro on reverse
- Made from maple melamine
- W900 x D400 x H900mm
- Top shelf: H800mm

YCRT0147	POA
----------	-----

**D. Extra wide open storage unit**

- Extra wide unit for storing larger items
- Ideal for storing wooden blocks
- Resources accessible from both sides
- W1200 x D400 x H660mm - Top shelf: H560mm

YCRT0136	£498.00
----------	---------

**E. Extra wide storage unit with back**

- Extra wide unit for storing larger items
- Velcro display surface on reverse
- Removable mirror attaches to Velcro on reverse
- W1200 x D400 x H660mm
- Top shelf: H560mm

YCRT0139	£595.00
----------	---------

**F. Mobile clear view browser/storage unit**

- 2 movable dividers & super tough clear sides
- Anti-scratch, low noise, lockable castors
- W900 x D400 x H660mm

YCRT0131	Storage space on lower level	£549.00
YCRT0132	With 6 Clear Tubs	£495.00
YCRT0133	With 6 baskets	£549.00

**G. Mobile storage unit with theatre add-on**

- Theatre add-on with washable fabric curtains (choice of Purple or Taupe Curtains)
- Anti-scratch, low noise, lockable castors
- Velcro display surface on reverse
- Removable mirror attaches to Velcro on reverse
- W900 x D400 x H1370mm - Top shelf: H560mm

YCRT0150	With 6 Clear Tubs	£629.00
YCRT0151	With 6 baskets	£725.00



Creative! Book Storage & Display Units



Removable mirror on reverse

A. Large access shelf unit

- Velcro display surface on reverse
- Removable mirror attaches to Velcro on reverse
- W1200 x D400 x H1000mm - Top shelf: H720mm

YCRT0141 £698.00



B. Mobile tall storage unit

- Holds 9 clear tubs or baskets
- Maximises storage
- Anti-scratch, low noise, lockable castors
- W900 x D400 x H900mm - Top shelf: H800mm

YCRT0142 With 9 Clear Tubs £579.00
YCRT0143 With 9 baskets £659.00



C. Large double-sided trolley

- Double-sided unit
- Holds up to 30 small baskets (sold separately)
- Anti-scratch, low noise, lockable castors
- W1000 x D500 x H1000mm - Top shelf: H720mm

YCRT0144 £595.00



D. Large book display unit

- Larger height & width gives more room for books
- Storage at back for tall books & additional shelf
- Four large book display shelves
- Baskets not included (sold separately)
- W1200 x D400 x H1000mm - Top shelf: H770mm

YCRT0145 £695.00



E. Double-sided book display unit

- Two large accessible book display shelves
- Storage at back for tall books
- W900 x D400 x H660mm

YCRT0140 £549.00



F. Mobile tall book display

- Four large book display shelves
- Storage at back for tall books & extra shelf
- Anti-scratch, low noise, lockable castors
- Sturdy construction

YCRT0126 W900 x D400 x H800mm £529.00



G. Mobile double-sided trolley

- Double-sided unit
- Anti-scratch, low noise, lockable castors
- W900 x D400 x H800mm
- Top shelf: H560mm

YCRT0127 £599.00



H. Mobile trolley with display & mirror back

- Mobile unit with 3 shelves
- Anti-scratch, low noise, lockable castors
- Velcro display surface on reverse
- Removable mirror attaches to Velcro on reverse
- W900 x D400 x H800mm - Top shelf: H560mm

YCRT0128 £539.00

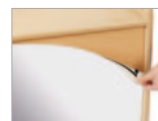

Removable mirror on reverse

Creative! Medium Height Display Tray Units

Designed to fully coordinate with the Creative! range, our tray storage units are made from a premium MDF core with clear lacquered edges. Units are designed with flexible runners to house different depths of trays - maximising storage options and allowing units to be easily reconfigured. The reverse of each unit features a loop nylon Velcro fabric that can be used for display and provides a more tactile surface for young children. Tray units benefit from:

- Runners which accommodate all Grattells tray types: Shallow, Deep, Extra Deep and Jumbo
- Heavy duty lockable furniture castors with low noise, anti-scratch wheels
- Creative! panel connector compatibility
- Loop nylon Velcro fabric on reverse of unit, which can be used to display work, projects etc



A. Tray storage unit (730mm height)

- 1 column tray storage unit suitable for shallow and deep trays
- Please specify tray colour when ordering
- Anti-scratch, low noise, lockable castors
- Velcro display surface on reverse
- W360 x D465 x H730mm

YCRT0154	3 Deep Trays	£379.00
YCRT0155	2 shallow and 2 deep trays	£339.00
YCRT0156	6 shallow trays	£339.00



B. Tray storage unit (730mm height)

- 2 column tray storage unit suitable for shallow and deep trays
- Please specify tray colour when ordering
- Anti-scratch, low noise, lockable castors
- Velcro display surface on reverse
- W700 x D465 x H730mm

YCRT0157	6 Deep Trays	£449.00
YCRT0158	4 shallow & 4 deep trays	£449.00
YCRT0159	12 shallow trays	£469.00



C. Tray storage unit (730mm height)

- 3 column tray storage unit suitable for shallow and deep trays
- Please specify tray colour when ordering
- Anti-scratch, low noise, lockable castors
- Velcro display surface on reverse
- W1045 x D465 x H730mm

YCRT0160	9 deep Trays	£695.00
YCRT0161	6 shallow & 6 deep trays	£569.00
YCRT0162	18 shallow trays	£698.00



D. 2 Column shelf storage

- Storage unit with space for 4 jumbo size trays
- Anti-scratch, low noise, lockable castors
- Velcro display surface on reverse
- Please specify tray colour when ordering
- W700 x D465 x H900mm

YCRT0163	No Trays	£398.00
YCRT0164	4 Jumbo Trays	£498.00



E. Welsh dresser display storage

- Storage unit with choice of tubs or baskets
- Velcro display surface on reverse
- W900 x D400 x H1260mm

YPT946	6 Clear Tub's	POA
YPT947	6 Baskets	POA



F. 4 Column shelf storage

- Storage unit with space for 8 jumbo size trays
- Anti-scratch, low noise, lockable castors
- Velcro display surface on reverse
- Please specify tray colour when ordering
- W1386 x D465 x H900mm

YCRT0167	No Trays	£595.00
YCRT0168	8 Jumbo Trays	£745.00



G. Low level circular storage unit

- Perfect centre piece for any room
- Anti-scratch, low noise, lockable castors
- Ideal height for play surface
- W890 x D890 x H540mm

YCRT0171	8 clear curved trays	£679.00
YCRT0172	8 curved baskets	£795.00



Solid Tray Colours



Translucent Tray Colours





A. Tray storage unit (900mm height)

- 3 column tray storage unit suitable for shallow and deep trays
- Please specify tray colour when ordering
- Anti-scratch, low noise, lockable castors
- Velcro display surface on reverse
- W1045 x D465 x H900mm

YCRT0173	12 Deep Trays	£629.00
----------	---------------	---------

YCRT0174	6 shallow and 9 deep trays	£729.00
----------	----------------------------	---------

YCRT0175	24 shallow trays	£629.00
----------	------------------	---------



B. Tray storage unit (1080mm height)

- 3 column tray storage unit suitable for shallow and deep trays
- Please specify tray colour when ordering
- Anti-scratch, low noise, lockable castors
- Velcro display surface on reverse
- W1045 x D465 x H1080mm

YCRT0176	15 Deep Trays	£679.00
----------	---------------	---------

YCRT0177	6 shallow and 12 deep trays	£689.00
----------	-----------------------------	---------

YCRT0178	30 shallow trays	£790.00
----------	------------------	---------



C. Tilt tote storage (660 x 900mm)

- Inclined for easier access
- Anti-scratch, low noise, lockable castors
- Tub/basket height 190mm (deep)
- W900 x D400 x H660mm

YCRT0179	6 Clear Tubs	£498.00
----------	--------------	---------

YCRT0180	6 Baskets	£539.00
----------	-----------	---------



D. Tilt tote storage (800 x 900mm)

- Inclined for easier access
- Anti-scratch, low noise, lockable castors
- Tub/basket height 120mm (shallow)
- W900 x D400 x H800mm

YCRT0181	9 Clear Tubs	£498.00
----------	--------------	---------

YCRT0182	9 baskets	£598.00
----------	-----------	---------



E. Tilt tote storage (800 x 1190mm)

- Inclined for easier access
- Anti-scratch, low noise, lockable castors
- Tub/basket height 120mm (shallow)
- W1190 x D400 x H800mm

YCRT0183	12 Clear Tubs	£498.00
----------	---------------	---------

YCRT0184	12 baskets	£689.00
----------	------------	---------



F. Stepped storage right hand

- Great for presentation
- W950 x D400 x H900mm

YCRT0187	6 Clear Tubs	£598.00
----------	--------------	---------

YCRT0188	6 Baskets	£698.00
----------	-----------	---------



G. Stepped storage left hand

- Great for presentation
- W950 x D400 x H900mm

YCRT0189	6 Clear Tubs	£598.00
----------	--------------	---------

YCRT0190	6 Baskets	£698.00
----------	-----------	---------



H. Plan chest

- 6 drawer plan chest, takes A1 paper
- Made from durable, hard-wearing, maple melamine
- High quality runners for smooth operation
- W1015 x D710 x H800mm

YCRT0191		£845.00
----------	--	---------

Creative! Wooden Tables & Chairs

- All Tables have a solid beech frame with a maple melamine top which is easy to clean, hygienic and scratch resistant
- Rounded corners for classroom safety
- Solid Beech legs ensure stability
- Available in a variety of height options to accommodate all ages
- All Tables and Chairs BS EN 1729 Compliant



Most tables are available as height adjustable at no extra cost, please contact us



A. Pack of 4 beech stacking chairs

- Supportive, curved backrest
- Beech & plywood construction
- BS EN 1729 compliant

	Seat Height	For Table Height	
YCRT0436	210	400	£345.00
YCRT0437	260	460	£345.00
YCRT0438	310	530	£389.00
YCRT0439	350	590	£389.00



B. Square table

YCRT0402	W695 x D695 x H400mm	£239.00
YCRT0403	W695 x D695 x H460mm	£239.00
YCRT0404	W695 x D695 x H530mm	£239.00
YCRT0405	W695 x D695 x H590mm	£239.00



C. Creative! small round table

- W500 x D500 x H320mm

YCRT0304	£198.00
----------	---------



D. Small rectangular table

YCRT0407	W960 x D695 x H400mm	£285.00
YCRT0408	W960 x D695 x H460mm	£285.00
YCRT0409	W960 x D695 x H530mm	£285.00
YCRT0410	W960 x D695 x H590mm	£285.00



E. Rectangular table

YCRT0412	W1120 x D560 x H400mm	POA
YCRT0413	W1120 x D560 x H460mm	POA
YCRT0414	W1120 x D560 x H530mm	POA
YCRT0415	W1120 x D560 x H590mm	POA



F. Large rectangular table

YCRT0417	W1500 x D695 x H400mm	£298.00
YCRT0418	W1500 x D695 x H460mm	£298.00
YCRT0419	W1500 x D695 x H530mm	£298.00
YCRT0420	W1500 x D695 x H590mm	£298.00



G. Circular table

YCRT0422	Dia. 1000mm x H400mm	£279.00
YCRT0423	Dia. 1000mm x H460mm	£279.00
YCRT0424	Dia. 1000mm x H530mm	£279.00
YCRT0425	Dia. 1000mm x H590mm	£279.00



H. Trapezoid table

YCRT0427	W1120 x D560 x H400mm	£269.00
YCRT0428	W1120 x D560 x H460mm	£269.00
YCRT0429	W1120 x D560 x H530mm	£269.00
YCRT0430	W1120 x D560 x H590mm	£269.00



I. Semi circle table

YCRT0432	W1630 x D560 x H400mm	POA
YCRT0433	W1630 x D560 x H460mm	POA
YCRT0434	W1630 x D560 x H530mm	POA
YCRT0435	W1630 x D560 x H590mm	POA

10 Year
Guarantee

A. Baby changing unit with steps

A versatile, stable and sturdy unit with anti-slip steps to assist toddlers in getting to the top. When not in use, the steps simply slide into the underside of the changing unit.

- Spacious, lockable cupboard
- Two height adjustable shelves
- Large changing surface with high sides for comfort and safety
- Includes a Wipe clean changing mat
- Anti-slip treads on steps

YCRT0193 W1100 x D610 x H910mm £785.00

B. 2-in-1 art easel and storage trolley

- Double-sided 2-in-1 art easel and storage trolley
 - One side Drywipe and one side chalkboard
- Wipe clean maple melamine construction
- Anti-scratch, low noise, lockable castors
- Provides useful arts and crafts storage with an upper easel making this a compact, versatile art station for any classroom!
- Includes 8 clear paint pots and 4 shallow tubs
- Space for storage in centre of unit
- Features paper clip on each easel

YCRT0202 £779.00

C. Mobile dressing up unit

- Suitable for 3 years+
- 6 coat hooks on each side
- Full length safety mirror
- Handy storage compartment at top of unit
- Storage area in base of trolley
- Supplied with 3 clear tubs for visible storage
- Anti-scratch, low noise, lockable castors

YCRT0195 W1000 x D400 x H1100mm £579.00



D. Baby changing unit

Mobile baby changing unit with two spacious storage shelves and high quality lockable castors. Sturdy maple melamine construction with rounded, lacquered edges.

- Lockable castors for easy mobility
- Hygienic wipe clean melamine surfaces
- Includes wipe clean changing mat

YCRT0192 W830 x D610 x H880mm £389.00



E. Drying rack

- 10 adjustable drying racks fit up to A2 paper
- Holds up to 20 racks (10 sold separately)
- Racks are fully removable for easy cleaning
- Wipe clean hard-wearing melamine surfaces
- Anti-scratch, low noise, lockable castors

YCRT0200 W710 x D510 x H1085mm £779.00



F. Double-sided art resource unit

- Supplied with 3 clear tubs and 4 clear paint pots
- Pot holders and storage on top for additional pots
- Small shelves for baskets or resources
- Ribbon reel holder
- Anti-scratch, low noise, lockable castors

YCRT0201 W900 x D400 x H800mm £659.00

A. Tall den cave set

- Includes two open storage units and the den cave roof add-on
- Baskets available separately
- W2250 x D900 x H1400mm
- Play Space: W1450 x D900 x H1400mm

YCRT0203	Blue Roof	£995.00
YCRT0204	Brown Roof	£995.00



B. Indoor/outdoor folding den & canopy

- Unique folding mechanism, easy to assemble and move between rooms, indoors or outdoors as required
- Endless possibilities – this Den can be decorated to match any theme
- Made from high quality, durable birch plywood
- Suitable for both indoor and outdoor use (must be stored indoors)
- Rounded corners and lacquered safety edges
- Available with a range of accessory options – see below



YCRT0207	W1700 x D1120 x H1160mm	£425.00
----------	-------------------------	---------



C. Camouflage den accessory kit

- Ideal for outdoor use as a secret hideaway
- High Quality washable camouflage fabric top cover
- 4 x Camouflage side net curtains
- Fabric cover has easy access openings at the front and back
- Splash proof wipe clean Lime Green floor mat

YDKITOC	£298.00
---------	---------



D. Rainbow den accessory set

- 3 x sensory mesh drapes (Red, Blue and green)
- 3 x Cushions (Red, Orange and Yellow)
- Large Bolster cushion (multi-coloured)
- Splash proof and wipe clean lime green floor mat

YDKIT-R	£325.00
---------	---------



E. Blackout sensory den kit

- Ideal for sensory play areas and quiet spaces
- High Quality washable blackout fabric cover
- Fabric cover has easy access openings at the front and back
- Splash proof wipe clean black floor mat

YDKIT-BO	£329.00
----------	---------

A



Soft Seating

A. Quilted tub chair & sofa

- Eyecatching tub chairs and 2-seater sofas upholstered in wipe clean vinyl
- Colours: Red, Green, Blue*
- Chair dimensions: W470 x D460 x H495mm
- Sofa dimensions: W910 x D460 x H495mm

YQTC	Chair	POA
YQTS	Sofa	POA

* Please specify colour

B



B. KomfiTub children's tub seats

Smart child size tub chairs & sofas with chrome look feet.

- Seat height of 350mm to suit nursery & primary age children
- Priced upholstered in a wipe clean vinyl fabric, but can also be upholstered in fabric in a choice of colours
- Dimensions height 650mm, chair is W600mm, 2-seater W1000mm

Y310240	Tub Chair	£465.00
Y310242	Tub 2 Seater	£695.00

Wide choice of Just Vinyl or fabric options

C



C. Easy junior seating

- Modular child size soft seating
- Can be ordered as single units, or why not combine to make a cosy reading corner?
- Available in Just colour vinyl or any fabric from the Advantage range
- Dimensions: D480mm, seat height 310mm

Y310206	Single Chair W405mm	each	£181.70
Y310208	2 Seater W810mm	each	£283.20
Y310210	3 Seater W1215mm	each	£337.10
Y310212	Corner Unit W770mm	each	£427.80
Y310214	Armchair	each	£290.80
Y310216	LH Arm Chair	each	£227.40
Y310218	RH Arm Chair	each	£227.40
Y310220	Square Coffee Table W395mm	each	£129.00

Tree Stump Soft Seating

- Features a realistic high-definition photographic quality printed design
- Bark print on the sides and wood grain detail on top with a plain brown fabric base
- Lightweight and can be easily transported, stacked and stored
- Made from strong durable 100% waterproof wipe clean polyester fabric for quick and easy maintenance
- Suitable for indoor and outdoor use
- Suitable for children and adult use
- Fire retardant to BS5852
- Double stitching for extra strength



A. Pack of 4 tree stumps

- 1 Large and 3 Small pouffes
- Small Pouffe: D380 x H200mm
- Large Pouffe: D450 x H350mm

Y4TREESTO3520 £239.00



B. Pack of 2 large tree stumps

- Large Size can be used by both children and teachers
- Dimensions: D450 x H350mm

Y2TREESTO35 £129.00



C. Pack of 3 small tree stumps

- Sturdy and firm seats for children
- Dimensions: D380 x H200mm

Y3TREESTO20 £189.00



D. Multi seat foam log

- Comfortably seats up to 3 children
- Ideal for one-one reading
- Size: L1000 x D400 x H250mm

YFMLOG25 £259.00



E. Nature print bean bags

- Bring a sense of nature into your classroom with these printed bean bags in 3 designs - Autumn Leaves, Summer Meadow & Spring Grass
- Classic rounded shape provides a comfortable and supportive seat
- Made from water resistant fabric - suitable for indoor and outdoor use
- High-definition photographic printed designs
- Lightweight, portable and fire retardant to BS5852
- Wipe clean polyester for quick and easy maintenance with double stitching for strength
- Dimensions: Height 630 x Dia. 640 mm

YNBBMEAD	Summer Meadow	£129.00
YNBBGRASS	Spring Grass	£139.00
YNBBLEAVES	Autumn Leaves	£119.00



Seasons

F. Indoor/outdoor carry cushions (packs of 10)

- Set of realistic digitally printed and natural coloured carry cushions
- Easy-grab handles make these lightweight portable cushions perfect for young learners
- Free storage bag for easy storage
- Cushions are stackable when not in use
- 100% waterproof and wipe clean polyester for quick and easy maintenance
- Suitable for Indoor and outdoor use
- Fibre pad filling provides a comfortable base to sit on or as a cushion to lean on
- Cushion dimensions: Length 430 x Width 430 mm

YNTURCC43	'Nature' Print Cushions	£249.00
YSESNCC43	'Seasons' Print Cushions	£249.00



Nature

Bean Cushions & Seats

- Good value range of quilted cover, bean-filled seating suitable for younger years
- Wipe clean fabric so can be used both indoors or outdoors.
- All items meet the relevant flame retardancy standards.
- Component parts tested to BS 5852 Ignition source 5.



Best Seller



A. Quilted flop seat

- Comfortable seat for young children
- Soft quilted cover in a range of bright colours: Aqua (AA), Lime (LI), Orange (OR), Yellow (YW), Purple (PP) or Red (RD) - please specify

YFLOP W500 x D660 x H520mm £129.00

B. Small round quilted pouffees

- Ideal for foundation stage children
- Size W300 x D300 x H340mm
- Pack of 6 assorted colours

Y330200 pk 6 £218.40

C. Small square quilted pouffees

- Ideal for foundation stage children
- Size W300 x D300 x H340mm
- Pack of 6 assorted colours

Y330202 pk 6 £403.00



D. Large quilted bean cubes

- Suitable for children in Key Stage 1 or 2
- Size 450 x 450 x 450mm
- Assorted Colours

Y330204 pk 6 £480.00



E. Toddler beanbags

- Mini, toddler sized bean bags
- Size: W400 x D400 x H300mm
- Pack of 5 assorted colours

Y330206 Assorted pk 5 £342.00



F. Quilted outdoor cushions

- Small square cushions for individual child seats with carrying handle
- Pack 10 (2 each Red, Aqua, Lime, Orange & Yellow)
- Size: W400 x D400 x H180mm

Y330208 Assorted pk 10 £245.90



G. Pack of 10 Sensory Soft Cushions

- Free storage bag included
- Soft tactile fleece offering sensory experience
- Helps to calm, reduce stress and anxiety
- Machine washable for easy maintenance
- Fibre-filled for comfort

YSSCOLC30 W3000 x L3000mm £145.00



H. Primary School Bean Bag Chair

- Lightweight bean bag for use indoors or out
- Wipe clean, durable, waterproof fabric, double stitched for extra strength
- Available in Red, Blue, Lime, Purple, Light Grey, Teal, Ochre - please specify

YPRIBBCH01 D580 x H560mm POA

Smile Soft Seating

- Tough enough to take rough and tumble treatment, yet light enough for children to move around
- Mix colour schemes and other items from our range to create your own personal seating environment
- Choice of 3 seat heights to suit nursery & primary years - choose from 310mm, 350mm or 380mm
- Can be upholstered in any choice of vinyl colour (see page 291) or in a choice of fabrics
- Smaller orders may incur a carriage charge
- Please specify fabric colour & seat height



Now in
3 seat
heights



Best
Seller

A. Smile circular chair

- Overall height 510mm
- W400 x seat D350 Dia.400mm

YKCF001

£265.00



B. Smile circular pouffe

- W400 x seat D400

YKCF003

£185.00



C. Smile segment pouffe

- W310 x D400

YKCF004

£185.00



D. Smile outer curved pouffe

- W350 x D400

YKCF007

£185.00

Smile Shapes

- An extension to the range
- Choice of 3 seat heights - 310, 350 or 380mm & 3 shapes
- Configure into many different layouts
- Please specify fabric colour & seat height



E. Wedge stool

- W400/530 x D400mm

YKCF008

£249.00

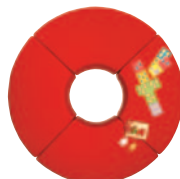

F. Quadrant stool

- 4 together form a circle (as shown)
- W300/850 x D400mm

YKCF009

£298.00



G. Tangent stool

- 2 together form a cross shape
- W560/1000 x D400mm

YKCF010

£329.00



H. Block stools

W x Dmm

YKCS001	400 x 400	£249.00
YKCS002	790 x 400	£298.00

Floor Cushions & Trolleys

- Ideal for group reading & teaching activities
- Wipe clean cushions made from high quality vinyl
- Items C & E, cushion colours may vary



Supports group discussion

A. Emotion floor cushions

- Pack of six cushions with multi curricular applications
- Useable as stepping stones or wipe clean story cushions

Size each Dia x H

Y330006	350 x 60mm	£129.00
Y330008	350 x 60mm	£129.00

B. Emotion cushion trolley

- Trolley supplied with 12 donut style cushions
- One side shows facial expression, reverse has key discussion word for group activity
- Trolley size W700 x D360 x H430mm

Y330003 Emotion Cushions & Trolley £298.00

Extra Value



Also suitable for outdoor play.



C. Plain coloured donut cushions trolleys

- Multi-cushion trolleys comes with 12 or 24 assorted coloured 350mm diameter floor cushions
- Trolley size W700 x D360mm
- 12 seat H430mm, 24 seat H730mm

YFN0080	12 Seat Trolley	£295.00
YFN0079	24 Seat Trolley	£549.00

D. Square cushion trolley

- Brightly coloured 350mm square cushions for classrooms & reading areas
- Cushions are washable at 30°C
- Trolley size W800 x D380 x H400mm comes with 32 assorted coloured cushions 350 x 350 x 20mm

Y330001 £395.00

Trolleys available separately - please ask for pricing



E. Ladybird counting cushions

- Encourages numeracy skills
- Great for group activities & quiet reading times
- Pack of 13 includes 12 small ladybird cushions (390 x 40mm) numbering from 1 to 12, and 1 larger (480 x 40mm) teacher cushion
- Removable washable covers
- Includes free holdall

Y330014 pk 13 £195.00

Carpets & Playmats

Carpets on this page have a compact, flatter pile than the heavy duty pile carpets on the following pages.



A. Multi-cultural welcome carpet

- This highly visual carpet has a children around the world theme showing children from different cultures and the word "welcome" in multiple languages
- A durable carpet with an anti slip backing ideal for both the school entrance or the classroom
- Size: W2000 x D1300mm

Y330308

£119.00



B. Rainbow numbers carpets

- 2 sizes of brightly coloured number carpet
- Ideal for teaching basic numeracy skills
- Choose from 1-100, size: W2 x D1.5m, or smaller 1-24, size: W1.5m x D1m
- Durable tuf-loop

Y330300 1-100 Carpet

£129.95

Y330302 1-24 Carpet

£95.00

Outdoor Carpets

- Great for teaching children about the natural world around them, or for outdoor play
- A lighter weight pile making them easier to move
- Include hardwearing, waterproof backing for outdoor use
- For outdoor playgrounds or grass areas



C. Outdoor hopscotch mat

- Ideal for group activities and outdoor play
- Size 3 x 1m
- Outdoor tuf loop

Y330304

£149.00



D. Garden outdoor mat

- 3m x 2m

Y330306

£275.00

Please ask for details on our range of outdoor mats

Activity Rugs

- High quality and heavy duty tufted pile, soft texture rugs
- Non crease with a non-slip back
- Stain-resistant coating and washable
- Distinctive and brightly coloured classroom relevant designs
- Stitch binding on all edges to prevent fraying
- Heavy duty pile for comfort

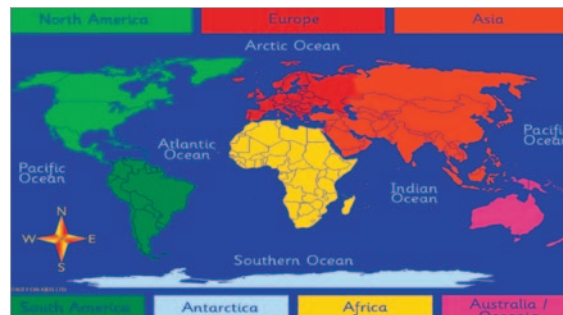

A. Primary world multi-cultural rug

- Brightly coloured, circular rug accurately depicting children from around the world
- Designed to engage discussion into ethnicity and develop cultural and religious awareness
- Ideal group learning aid to introductory multicultural studies
- Size 2m x 2m, circular
- Heavy duty pile

Y330314

£279.00

B. Rainbow abc rectangle carpet

- A bright addition to the classroom or nursery environment
- Features 20 brightly coloured ovals surrounded by the alphabet in upper and lower case
- Size: 3m x 2m

YMAT1014

£359.00

Large range of mats available. Please ask if you cannot find the design you need.

C. Seasons carpet

- Colourful circular floor carpet covering the seasons, weather and months
- Functional, hard-wearing carpet ideal for group floor reading activities and discussions
- Heavy duty thick soft pile
- Anti-slip rubber backing
- Size: 2 x 2m

YMAT1202

£275.00

Activity Rugs

- Heavy duty pile for comfort



A. Rainbow semi-circle carpet

- Extra large carpet for large groups
- Size W2m x D4m
- Features 24 placement spots and 1 teacher spot

Y300308

£479.00

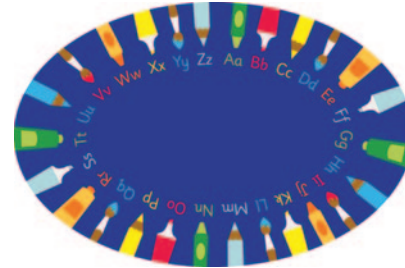

B. Oval pencils alphabet carpet

- This highly visual oval carpet depicts pencils and the alphabet
- Excellent for group use & word recognition
- Size W3m x D2m
- Heavy duty pile

YMAT1007

£359.00



C. Fruit placement carpet

- Large square 3m x 3m carpet with soft, heavy duty pile for comfort
- Colourful fruit icons
- To seat 30 children
- Ideal for healthy eating topics

Y300312

£380.00



D. Life cycle carpet

- Colourful circular carpet showcasing 4 examples of life cycles in the animal and plant kingdoms
- Functional, hard-wearing carpet ideal for group floor reading activities and discussions
- 2 x 2m; heavy duty thick soft pile
- Anti-slip rubber backing

YMAT1213

£275.00

Sand & Water Play



- Encourages outdoor play
- All sand & water trays have sturdy plastic trays with robust, powder-coated metal frames



A



A. Sand & water play table

- Set includes tray with handles, stand with locking castors, breathable lid and plug for drainage
- Tray Colour: Blue

YEY10340BL	Height 40cm	POA
YEY10358BL	Height 58cm	POA

B



B. Oval sand & water table

- A tinted clear sand and water table with a multi level design and screw-on water valve
- Height 58cm

YFSWTB	POA
--------	-----

C



C. Circular sand & water play table

- Durable plastic multi level tray table with a heavy duty steel frame and plastic lid
- Height 58cm

YEY02398	POA
----------	-----

Sand & Water Play



Page Link - see page

For wooden
sand &
water play

129



A. Water tray & stand

- Sturdy plastic tray with frame and wheels
- Tray available in Red or Clear
- Lid sold separately

YEY02530	Red	POA
YFCROCK	Clear	POA
YFSLID	Lid	POA



A

B. Creative! sand & water stations

- Suitable for 2 years+
- Sturdy frame with two wheels & two fixed legs
- Polycarbonate tray for sand or water
- Suitable for use with Canopy & Accessory Kit YCRT0199
- YCRT0198 has room underneath for clear tubs

YCRT0197	W1100 x D620 x H440mm	£569.00
YCRT0198	W1100 x D620 x H590mm	£595.00



B

C. Creative! canopy and accessory kit

- Canopy made from washable, wipe clean fabric
- Suitable for 440mm and 590mm units
- Easy to attach to Sand & Water stations using the Allen key & bolts supplied
- Incl.: 2 x funnels, plastic tubing & activity shelf
- Height when attached to YCRT0197: H1440mm and YCRT0198: H1590mm

YCRT0199	W1200 x D560 x H1100mm	£325.00
----------	------------------------	---------

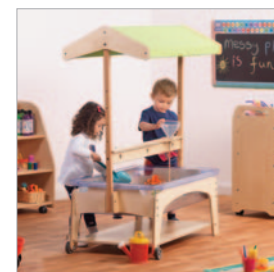

C

Height Adjustable Mobile Classroom Easels

- These mobile easels with magnetic whiteboards are a perfect teaching aid for front of class
- Sturdy A frame construction guarantees safety & stability at all heights
- Each easel has quick & easy height adjustments to accommodate all age groups - simply click on and off at the height required
- Full length integral pen & book tray and adjustable flipchart fittings
- Castors are fully locking
- Choice of Red-RD or Blue-BL high gloss powder coated metal frame



A. Large a-frame mobile easel

- 4 height adjustments from 1110mm up to 1790mm
- 900 x 900mm magnetic whiteboard
- Two plastic storage trays

Y300400* £459.70

*Please specify frame colour Red-RD, or Blue-BL

B. Small a-frame mobile easel

- Smaller version of the large easel for younger years
- Height adjustable from 820 - 1190mm
- Magnetic whiteboard size is 600 x 600mm
- Supplied with 1 x storage tray

Y300402* £419.20

*Please specify frame colour Red-RD, or Blue-BL

C. Landscape style easel

- Adjusts from 785 - 1460mm in 5 increments
- Single boarded easel comes c/w 3 storage trays, double boarded with 2 storage trays
- Board size: 900 x 900mm

Y300404* Single Boarded Easel £456.40

Y300406* Double Boarded Easel £523.00

*Please specify frame colour Red-RD, or Blue-BL

Table Easels

- Solid beech table frames with holes for paint pots etc.
- Magnetic easel sections can be removed & used as floor easels for younger children
- Add paper for drawing & painting by loosening the wheels at the top
- Supplied flat pack for easy self-assembly



Easy Self Assembly



D. 2-person table easel

- Dimensions H1180 x W900 x D600mm

YEAS6592 £445.00



E. 4-person table easel

- Allows 2 children to work side by side
- Dimensions H1180 x W1480 x D600mm

YEAS6542 £495.00



F. 4-sided table easel

- 4 easel faces in a square making a more compact easel
- Dimensions H1180 x W900 x D600mm

YEAS6552 £469.00

Play Corners

- Extensive range of solid beech modular furniture with scratch resistant clear lacquered finish
- Designed to bring storage units and creative play areas together
- Modules fix together with solid beech connecting posts
- Ideal for creating "areas" from larger rooms and establishing boundaries
- Supplied flat packed for easy self-assembly, please ask for pricing for assembly if required
- Accessories and soft furnishings shown are for photographic purposes only and are not included



Some items are available separately as single units – please ask for prices & details

A. Reading corner

- 2 x 1200mm wide shelf units
- 2 x Curved shelf units
- 1 x Corner seating unit with lime cushions
- 1 x 600mm entrance arch
- 2 x Pk2 90 degree posts

Y320101

£2,795.00



B. Book corner

- 2 x Curved Shelves
- 1 x Open Bookcase/Shelf
- 1 x Storage Unit
- 1 x Entrance Frame
- 2 x (2 x 90 Degree) Posts
- Seating and kinderbox with mirrors not included

Y320110

set

£1,495.00



Many components are available separately if required – please ask for pricing

C. Shopping corner

- 2 x Curved Shelves
- 1 x Entrance Frame
- 1 x Shop Theatre
- 1 x Role Play Panel
- 1 x Angled Tidy Store
- 1 x (2 x 90) Degree Posts
- 1 x 2 x Wallplate
- Tables & chair not included

Y320109

set

£1,795.00



D. Display/store unit

- 2 x Corner Shelf Unit
- 1 x Cork Room Divider
- 1 x Storage Unit with Baskets
- 1 x Room Divider Cork
- 2 x 90 Degree Posts
- 1 x 90 Degree Double Posts

Y320115

set

£1,299.00

Wooden Play Furniture

Play modules

- Provides hours of fun for children in Nursery & Primary years
- Frame is free standing so easy to lift & move
- Also ideal for use on stage for school productions
- Arched frame & side panels 15mm beech plywood
- 25mm solid beech dowels form the frame
- Dimensions: W1800 x D1200 x H1200mm
- Supplied flatpacked for easy self assembly (or please ask for pricing for assembly)
- Canopy included in a choice of 3 colours: lime, orange & black
- Please specify colour when ordering



Available in:

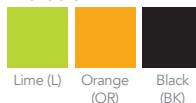

Easy Self Assembly



A. Play module

Y320150

£595.00



B. Play module with 2 sets of curtains

Y320152

£579.00



C. Play module with 2 sets of curtains, 6 scatter cushions & large mat

Y320154

£898.00



D. Stage play module

- Useful module for stage productions
- Also provides hours of fun in nursery or early years classrooms for role play
- Solid beech frame with MDF panels
- Open back and half height sides
- Curtains & accessories not included
- Dimensions W1800 x D1040 x H1700mm
- Supplied flat packed for easy self assembly

Y320156

£1,199.00



E. Shop canopy with angled tidy

- Choice of wicker baskets or trays, other contents not included
- Supplied flat packed for easy self-assembly

Y1394402 With Trays £749.00

Y1394412 With Wicker Baskets £798.00



F. Shop canopy with open bookcase

- Contents not included
- Supplied flat packed for easy self-assembly

Y1394422

£695.00



Easy Self Assembly

Please ask for costings for assembly

Natural Beech Storage Units

Double sided beech units

- Uniquely designed double sided units
- Made from 18mm Beech Faced MFC with ABS Edging
- The top of the units can be used as a Play Table and the solid beech frames surrounding the tops prevent items from rolling off onto the floor
- One side has opening doors, or trays, reverse is open shelving
- Supplied flat pack with trays as shown
- Dimensions W940 x D610mm. Accessories not included



Easy Self Assembly

Please ask for costings for assembly



Reverse of items A-D is open shelving



A. Resource unit with doors

- Doors / open shelving reverse

Y1392002 £495.00



B. Display unit with mirror/top shelves

- Please choose tray colour

Y1392292 With Trays £695.00
Y352282 With Baskets £795.00



C. Book display unit

- Please choose tray colour

Y1392422 With Trays £4957.00
Y352412 With Baskets £649.00



D. Storage unit with easel

- Please choose tray colour

Y1392232 With Trays £595.00
Y352222 With Baskets £695.00



Front View



With Trays Sold Separately

E. Mobile art trolley

- Double sided mobile Art Resource trolley made from beech faced MFC with ABS soft edging.
- Incorporates solid beech beadings & rails
- Built-in scissor block & sections for paper, paints, art resources & ribbon rail
- One side has 9 storage compartments to hold plastic trays or willow baskets (sold separately)
- 24 assorted pots & art trays included

Y1393102 H960 x W965 x D600mm £799.00



Art Trolley with Baskets sold separately

Choose from baskets or plastic trays

Trays available in:

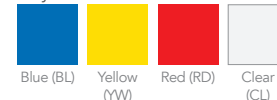

F. Deep wicker baskets

- W370 x D270 x H200mm
- Pack of 6

YBASKET pk 6 £182.75

Single Sided Storage

- Large range of interesting storage units in beech faced MFC with solid beech beading & ABS lippings
- Supplied flat packed for easy-self assembly
- Please ask for costings for assembly if required
- Units supplied with baskets or trays as shown

Please ask for costings
for assembly



Easy Self Assembly



Contents not include

A. Tiered access unit with 6 trays

- Supplied comes with 6 trays - please specify colour
- Dimensions H870 x W1015 x D460mm
- Also available with wicker baskets - ask for pricing

Y1381492	Right Hand Tiered Unit	£395.00
Y1381502	Left Hand Tiered Unit	£395.00

Trays available in:



Blue (BL) Yellow (YW) Red (RD) Clear (CL)



B. Tray & shelf unit

- Dimensions W1015 x D500mm

Y1360572	6 Shallow Tray Unit w/cork Panel	£395.00
Y350372	3 Deep Tray Unit w/flat Top	£249.00



C. Open display units

- H650mm x D425mm, curve unit W735mm, straight W960mm

Y354002	45 Degree Curve Unit	£295.00
Y354022	Straight	£379.00

Classroom Tidy Trolleys



- New range of high quality classroom tidy trolleys made from solid beech, finished in a clear natural lacquer
- All units supplied with castors for easy mobility
- Choose from plastic tubs (choice of Clear-CL, Red-RD, Blue-BL, or Yellow-YW), or wicker baskets for a more natural look
- Supplied flat packed for easy self-assembly - please ask about our assembly service if needed
- Single sided or double sided options



Please ask for costings
for assembly



Easy Self Assembly



D. Single tidy trolley

- Dimensions W860 x D410 x H810mm
- Supplied comes with 9 baskets, or tubs (please specify colour)

Y350000	Single Tidy with 9 Tubs*	£249.00
Y350002	Single Tidy with 9 Baskets	£398.00



E. Double-sided tidy trolley

- Dimensions W860 x D740 x H810mm
- Supplied comes with 18 baskets or tubs (please specify colour)

Y350008	Double Tidy with Tubs	£329.00
Y350010	Double Tidy with Baskets	£579.00

Page Link - see page

Lunchbox
& Bag
Storage

77,82,
83,85



A. Assorted nursery chairs

- Stackable, solid hardwood with a natural beech finish
- A pack of 4 in a range of 3 heights
- 1 each red, yellow, green & blue



YSTCHMIX1	H260mm	£213.40
YSTCHMIX2	H310mm	£224.40
YSTCHMIX3	H350mm	£251.50

B. Flower shaped tables

- Softly curved edge table forming a flower shape
- Lightweight table with an aluminium frame & legs and hardwearing ABS edging
- Dimensions L1200 x W1200mm in a choice of heights: H460, H530, H590 & H640mm
- Delivered flat packed for easy assembly
- Choice of 10 top colours and 4 PU edge colours
- Please specify height, top & edge colours



Y19200D	£369.00
---------	---------

Laminate Colours



Edge Colours

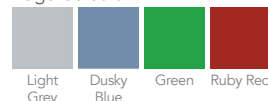

Primary Height Adjustable Tables

- Oval shaped adjustable legs - one size fits all
- Height adjustable for all primary sizes - from 400-640mm
- Easy allen key adjustment
- Premium 25mm top available in a wide range of colours
- Durable spray PU edge
- All table colours available with speckled light grey frame
- Some colours available with matching outer leg paint colour - see table colour chips below



C. Clover shape

- 1215 x 1097mm

D. Rectangular

- 1200 x 600mm

E. Semi circular

- 1200mm diameter

F. Trapezoidal

- 1200 x 600mm

G. Circle shape

- 1200mm diameter

YHAC12	£698.00	YHAR126	£398.00	YHASC12	£398.00	YHAT126	£498.00	YHARD12	£495.00
--------	---------	---------	---------	---------	---------	---------	---------	---------	---------

Top Colours Laminate

Available in matching outer frame paint colour

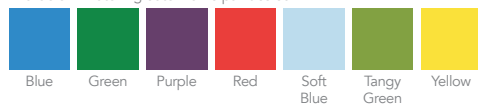

Available with speckled grey frame only

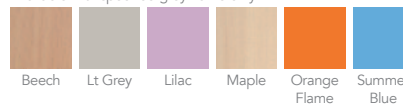

PU Edge colours:



For critical colour matching please ask for a sample



Please note that these tables are built to exacting standards and are tested to BS EN 1729-2:2006. Tested by FIRA, these tables are structurally suitable and sufficiently stable for **heavy** educational use.



Height Adjustable Themed Tables

- Height adjustable themed tables, perfect for group work & very popular in nurseries, primary schools & special schools
- Hardwearing, easy clean 25mm laminate tops with black PVC moulded edging and rounded corners
- 50mm black powder coated frame for scratch resistance and stability, with grey self-levelling feet
- All tables are height adjustable from 430 - 635mm in 25mm increments and suitable for wheelchair users
- The unique Tri-Lock™ leg strengthening system provides maximum leg strength in all heights and protects against multidirectional impacts



Best Seller

A. Horseshoe table

- Top dimension of 1675 x 1520mm

YFN0013A	Red	£425.00
YFN0014A	Blue	£425.00



Best Seller

B. Clover table

- Top dimension of 1026 x 1026mm
- Suits group work & student interaction. Seats 4

YFN0007A	Red	£239.00
----------	-----	---------



C. Arc table

- Top dimension of 1600 x 800mm

YFN005A	Red	£289.00
YFN006A	Blue	£298.00
YFN0149	Yellow	£292.50



Best Seller

D. Flower table

- Top dimension of 1525 x 1525mm
- Suits group work & student interaction. Seats 6+ students

YFN0010A	Red	£389.00
YFN0011A	Blue	£389.00



E. Rectangular table

- Premium quality rectangle table helping facilitate creative student teacher interaction
- Top dimension of 1500 x 750mm

YFN0156	Red	£279.00
YFN0157	Blue	£295.00



F. Teacher's flower table

- Designed for larger group teaching and is perfect for teacher student interaction
- Top dimension of 1525 x 1525mm

YFN0154	Blue Table	£362.50
---------	------------	---------

Outdoor Learning

Solid wood outdoor play furniture to create a living classroom.

- Helps children to explore & develop their potential through role play learning
- Encourages healthy outdoor play
- Made from durable, weather-resistant solid eucalyptus timber: a sustainable product from FSC certified sources
- Naturally occurring oils contain insect repelling properties
- Furniture can be left outside



A. Outdoor kitchen set

- Consists of 1 each outdoor sink, oven & stove, washing machine, refrigerator & microwave
- Dimensions 450 x 350mm x height 620 – 850mm
- Some items can be purchased separately

Y300150	£920.40
---------	---------



C. Sorting table

- Outdoor wooden bench c/w lid and undershelf
- Ideal for nature studies, or curriculum activities
- Dimensions H600 x W1200 x D400mm
- Wooden sorting boxes available separately to fit into top of bench.

Y300154	Sorting Table	£320.20
Y300156	Wooden Sorting Boxes pk 6	£151.40



B. Outdoor stacking benches

- 2 benches for outdoor use
- Requires some assembly
- Bench height 310mm

Y300160	Benches	pk 2	£136.20
Y300165	Parasol	each	£191.80



D. Water & sand table with pump

- Encourages exploratory water play
- Teaches children about water and its effects
- Includes stainless steel sink with pump that looks like a real water tap
- Tables can be repositioned in different layouts
- L1040 x W340 x H560-850mm

Y300170	Set of 3 Tables	£1,662.20
---------	-----------------	-----------

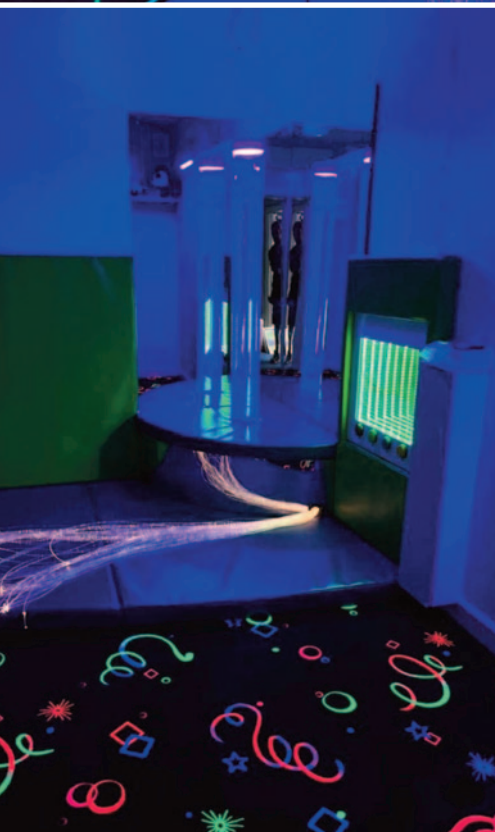
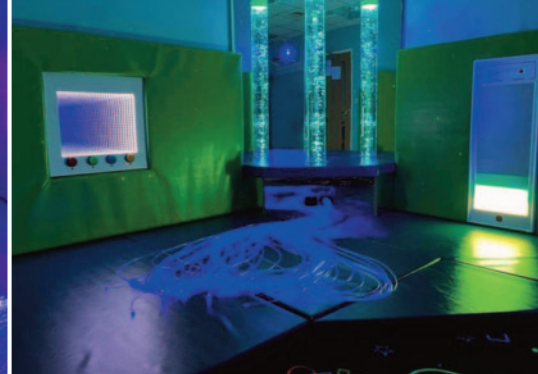
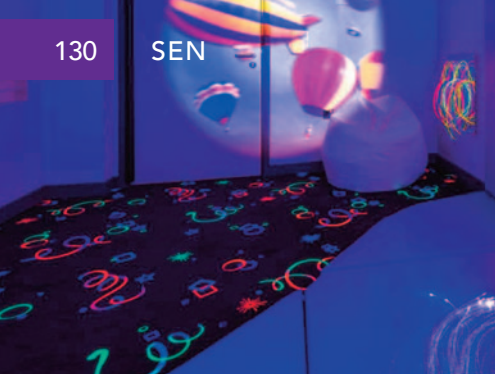

Sensory Rooms

SEN

Multi-sensory Environments	132-133
Light & Sound	134-135
Lights & Light Projection	136-137
Fibre Optics & UV Carpet	138
Light Control Apps & Infinity Tunnels	139
Hurricane & Bubble Columns	140-141
Bubble Column Podium	142
Bubble Walls	143
Soft Play, Rockers & Movement	144-145
Sensory Toys	146-147

Using our expert knowledge we can design a **sensory room** that is tailored to the needs and the ages of the users.

Please contact to find out more about our turn-key project solutions.

A



A. Acoustic cloud

- A sound-absorbing ceiling panel that improves the acoustics in sensory and learning environments, helping children concentrate and focus.
- Clouds are sold individually.
- The clouds are easy to install and will immediately transform the acoustics of your room
- Their whimsical design brings a fun visual element to spaces, turning plain ceilings into skies
- Suitable for a wide range of environments, from sensory rooms to classrooms and bedrooms

Y310800	each	£199.00
---------	------	---------

B

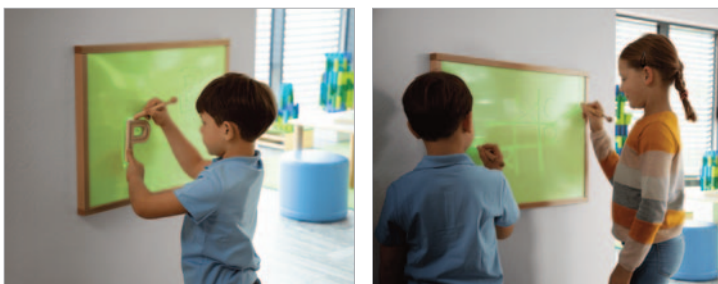

B. Play with light board

- A glowing luminescent art panel that encourages imagination, wonder and creativity
- Use fine motor skills and the handy wooden pens to draw on the panel
- Watch your creations magically light up and after a few moments they'll fade away
- Great for encouraging motor skills, hand-eye coordination, and creativity
- Size: Play Plate 46.5 x 64cm
- Light Pen 15cm long, Ø 1.7 cm

Y310802		£289.00
---------	--	---------

C



C. Cubey tactile wall

- Spin the three central dice to reveal a colourful, tactile surface – can you find the matching tactile square on the panel?
- Develop tactile, visual and cognitive senses
- Includes three central dice and twelve surrounding tactile surfaces with unique textures for sensory exploration and learning.
- Textures include: acrylic, stainless steel, perforated sheet metal, polished stainless steel, artificial turf, felt, suede, leather, Velcro, Velcro hooks, abrasive cloth & inoleum.

Y310803		£275.00
---------	--	---------

D



D. Gravity wonder wall

- Tactile wall with movement, tactile and visual activities to occupy fidgeting fingers
- Includes 2 tube tracks, 3 secure hourglasses, a glitter wall and a marble wheel
- Size: 100 x 90 x 18cm

Y310844		£1499.00
---------	--	----------



A. Feel & touch tactile wall panel sets

- A colourful wooden backed tiled sensory wall panel with three elements for tactile stimulation and exploration
- Set A: birch cylinders in varying heights, 4 different pressure pads made from foam with fabric covers, 4 empty cotton feely bags ready for filling with elastic cord fastening
- Set B: Semicircular birch rods, waves of Cork and fun fur, waves of felt and astroturf
- Can be mounted vertically or horizontally
- Size: 90 x 30cm.

Y310804	Set A	£299.00
Y310805	Set B	£249.00



A

B. Visual perception tactile wall sets

- A colourful wooden backed tactile wall panel with three elements for visual stimulation and exploration
- Set A: three rollers made from solid birch covered with shiny patterned foil, holographic foil, periscope with 2 adjustable perspex mirrors
- Set B: rotating discs on metal rods, optical illusion grid (grey dots with a cross effect) and colour mixing rollers
- Can be mounted vertically or horizontally
- Size: 90 x 30 cm

Y310806	Set A	£305.00
Y310807	Set B	£305.00



B

C. Acoustic perception tactile wall sets

- A colourful wooden backed sensory tactile wall panel with three elements for audio stimulation and exploration:-
- Set A: two metal balls which produce sound when rolled, rotating disc produces clicking noise. drag wooden balls over various surfaces to produce different scraping sounds
- Set B: rotating rainmaker, tambourine, whack and clack - hit the moveable wooden bars against one another to make them clack
- Can be wall mounted vertically or horizontally
- Size: 90 x 30 cm

Y310808	Set A	£305.00
Y310809	Set B	£305.00

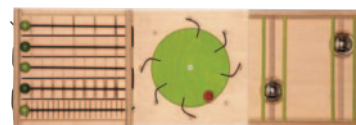

C

D. Kinetic wonder wall

- The Sensory Kinetic Wonderwall has a variety of features including bells to ring, discs to spin and mirrors
- Designed so the user can get all the visual stimulation that they need as all of the colours pop out at them, whilst having fun
- The sensory wall is also great for developing fine motor skills as they user is using their hands a lot to get the outcome desired
- Size: H775 X W670 x D90mm.

Y310843		£1,506.60
---------	--	-----------



D

A



A. Laser stars

- Transform ceilings and walls into bright galaxies filled with stimulatingly relaxing glowing stars. The Laser Star projector makes a perfect night light in bedrooms or portal to dreamy relaxation in dark or calming rooms
- **Starry Eyed:** Create a starry night whenever or whenever you like, in seconds. Plug in the Laser Stars projector to see dazzling stars shoot across your walls and ceilings – perfect for dreamy visual stimulation
- **Small But Powerful:** Whether you're looking to project galaxies onto your bedroom wall or across a whole hall – the Laser Star projector will paint beautifully bright constellations for you to enjoy their calming movement and stimulating visuals
- **Energy Saver:** After two hours, the Laser Star projector will automatically switch itself off, saving energy and conserving the glowing power of the green lasers inside the projector
- **Great For:** Autism, Kids and Adults, Visual Stimulation, Bedtime Routines, Calming, Dark Rooms, Sensory at Home, Sensory Bedrooms, Care Homes, Classrooms

Y310810

£169.00

B



B. RGB moving dots light effect

- The tabletop RGB Moving Dots Light Effect creates a stimulating light show in a darkened space that calms and distracts users
- 6 x 1W LEDs produce an array of coloured beams that are diverted through a rippled dome, creating a dynamic ceiling display with a sound-sensitive auto sequence
- Its compact size makes it practical for home environments, allowing you to quickly create a sensory space in a matter of seconds
- The dome can also be fixed to a wall or ceiling for a more permanent sensory fixture
- Size: 17.5 x 17 x 14cm

Y310812

£92.00

C



C. LED UV light panel

- A sturdy and powerful LED UV light that can be fitted to a wall or ceiling
- Reacts to UV sensory resources transforming their colours into an electric neon glow, perfect for building visual and tracking skills
- Size: 9.8 x 51.2 x 5.2cm (with brackets), 5.2 x 47.8 x 5.2cm (without brackets)

Y310813

£262.00

A. Large sound & light panel

- The sound-sensitive Large Sound & Light Panel panel is controlled by the sounds that you make. Clap, sing, stomp and explore the 13 different play modes and their stimulating colours and effects
- Ideal for active and calming sensory environments
- Size: H120 x W60 x D8cm

Y310811

£1,395.00



A

B. Sound & light panel

- Get visually stimulated with our sound sensitive sound and light panel that lights up certain colours depending on the pitch of the noise made, which will encourage the user to be more vocal. This is a fantastic cause and effect product that will keep the user intrigued for hours. It can be activated by either music or voice and there is a microphone and a sound sensitivity control included.
- You can decide how bright the lights are by the volume of the sounds you make. Each colour represents a different pitch. The deepest bass sounds glow red, higher pitched sounds illuminate orange, yellow, green and finally blue and purple for the treble. The brightness of the lights varies with the volume of the sound.
- Size: L24" x W24" x H4"

Y310849

£966.00



B

C. Infinity tunnel

- A sound-sensitive illusion that gives an impression of infinite depth, creating a stimulating sensory experience with two different modes for interactive or calming play
- Interactive mode: different sounds make different colours and patterns, so experiment with your voice, learn more about cause-and-effect, and create a visual light show
- Calm mode: sit back, relax and passively enjoy the automatic light show.
- Build confidence and communication skills, talk, sing or shout and watch as the tunnel illuminates in ever-changing sensory light
- Explore tactile senses by touching the screen, and watch as the light in the tunnel bends and warps
- Easy to clean and can be simply installed on walls in sensory rooms. Get in touch for more information
- Size: 72 x 60 x 11 cm.

Y310848

£1,049.00

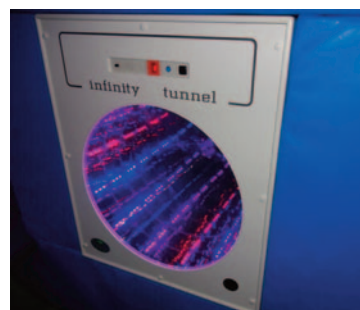

C

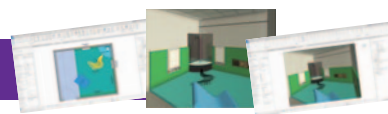

A



A. Solar 250 LED projector

- Projects your brightest dreams across rooms and onto walls. An extremely bright projector with its 2000 Lumen light capacity, and also energy-saving and easy to set up
- LED technology means the projector doesn't get too hot, leaving it safe to touch, while the absence of a motor removes any distracting humming noises.
- *To complete the Solar 250 LED Projector, you will need a Magnetic Wheel Rotator and additional Effect Wheels.
- Choose your View: The Solar Projector supports over 200 different types of effect wheels, from adventurous themes, blooming flowers, stimulating liquid patterns and customisable magnetic effects – project a view that best suits you.
- Cool Energy Saver: Specially designed to use as little energy as possible. Any energy that may have been lost to heat is instead channelled into the brilliant bright white light that's projected onto your walls, floors or ceilings. Perfect for anyone who's environmentally conscious.
- Portable Projector: This projector is powerful, robust and compact, allowing you to use it in whatever environment best suits you. Create a permanent fixture by hanging it from your wall or ceiling, or move it from room to room and let it stand tall on its own
- What else is needed?
Magnetic Wheel Rotator
Effect Wheels
- Ideal For: Autism, Dementia, Distraction, Visual Stimulation, Calming Rooms, Care Homes, Sensory Bedrooms, Hospitals, Sensory Rooms

Y310819

£467.00

B



B. Magnetic 6" effect wheel rotator

- Have you found the perfect magnetic effect wheel for your Solar Projector? You'll need this extra add on for it to work
- Opposites Attract: You can easily attach and remove the Magnetic Wheel Rotator from your Solar Projector, allowing you to switch between standard and magnetic effect wheels
- What else is needed?
Solar Projector
Magnetic Effect Wheels
- Magnetic 6" Effect Wheel Rotator to be used alongside our projectors for a stimulating and distracting visual experience

Y310820

£58.00

C. Pack of 3 magnetic 6" effect wheels

- 3 Magnetic effect wheels for use with the Solar projectors

Y310818

£118.00



A. Interactive light source

- A colour-changing light source that is compact, quiet, lightweight, and compatible with our range of fibre optics
- The colours of the light source will change automatically, but if you'd like to interact with the fibre optics, they're compatible with all of our colour controllers too
- 16 colour modes to choose from - perfect for building colour recognition, sensory preferences and a mood-lit atmosphere
- Colour Controllers aren't included and will need to be bought separately

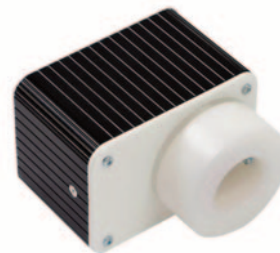

A

Y310830

£384.00

B. Sparkle light source

- Quiet, cool and long-lasting (approximately 50,000 hours)
- Colour wheel gives the popular sparkle effect for use with our full fibre optic range
- Automatically cycles through 16 different sensory colours, creating a calming, mood-inducing sensory environment
- If you'd like an interactive fibre optic experience, we'd recommend using the Interactive Light Source



B

Y310855

£221.00

C. Ladder lights

- Interactive rainbow Ladder Lights are a fantastic celebration of sound and colour
- Use your voice and light up the rungs of the ladder the louder you are, the brighter it will shine. Experiment with sound, volume and pitch by illuminating the ten coloured rungs, and alternate play by switching between the seven stimulating lighting modes for hours of sensory fun
- Ladder Lights are a favourite amongst speech therapists, as the panel encourages vocalisation, breath control and self-confidence. They stimulate visual senses as the ladder illuminates, and demonstrate the mechanics of cause and effect as sounds turn into colourful light
- Easy to install and can be safely embedded into safety padding, and mains powered
- Size: 107 x 38 x 20cm.



C

Y310850

£1,485.00

D. Light source wall holder

- Protect your light source and create a new sensory fibre optic feature
- Creates a secure space for you to keep your fibre optic light sources out of harm's way
- The holders have a mirrored front that beautifully reflects the colours and lights from the fibre optics and seamlessly integrates the light source into sensory rooms
- Hang the wall holder at any height on the wall, higher up to create a shimmering waterfall effect, or lower down for personal, up-close sensory exploration sessions
- Note: Light source and fibre optic tails are not included.



D

Y310840

£131.00

A

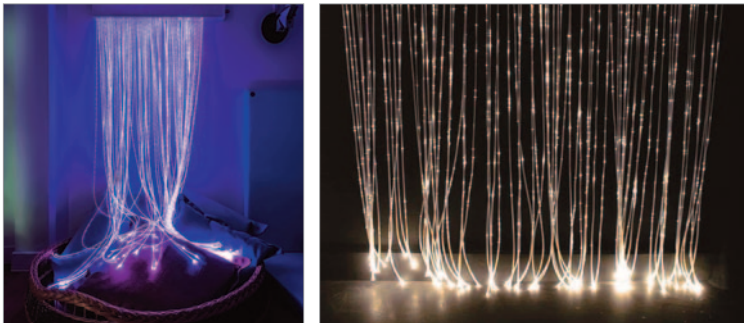

A. Fibre optic curtain

- A calming, shimmering 1m wide curtain of fibre optics - hang it above beds or beanbags and let users lie back and relax under the twinkling lights, or use it as a magical entrance to your sensory space, where users need to push the tails aside to enter the room
- The fibre optics automatically rotate through a rainbow of stimulating colours, acting as calming, passive stimulation. Although if you'd like more of an active session, you could connect an interactive light source to the curtain and control the fibre optics through a handy colour controller
- Calming visual and tactile stimulation, perfect for Sensory Rooms, Calming Spaces and Sensory Bedrooms.
- Includes an integrated light source
- Safe to touch, easy to wipe clean, robust strands, encourages an increased attention span, glowing visual stimulation

Y310853

£789.00

B

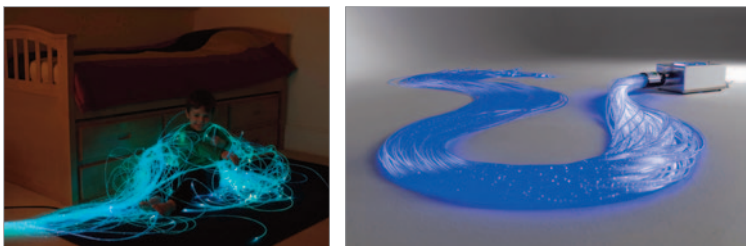

B. Fibre optic side glow - 100 tails 2m

- A beautiful spray of acrylic fibre optic tails that glow, sparkle and change colours creating a distracting and calming sensory experience
- Safe to touch, they let the user actively explore their tactile senses, they passively glow through a rainbow of sensory colours creating a dreamy visual effect, and they're long enough to drape over your body for intimate and personal sensory sessions
- For a more interactive experience, you can use an interactive light source to control the colours of the fibre optics to match your mood.
- Safe to touch
- Easy to wipe clean
- Robust strands
- Encourages an increased attention span
- Glowing visual stimulation
- This fibre optic core has 100 tails that are 2m long.
Please Note: This product requires a fibre optic light source

Y310854

£173.00

C



C. UV carpet

- Specially designed for use in sensory environments where there is a requirement for its striking, high-impact design. It really comes to life in areas which utilise UV black light, where the special light-reactive neon yarns appear to glow as if lit from underneath
- Made from 100% cut-pile nylon with a pile weight of 100g/m² and is heavy contract rated. It can be ordered to fit a whole or a section of a room or area
- UV mats are also available on request
- Priced per metre square
- Minimum Width: 4m

Y310847

£79.00

A. MSE Genie TV control

- The MSE App bundle has been created to make installation, set up, and play as simple as possible
- The bundle includes Apple TV and the MSE TV App – as well as a projector, the only extra you'll need is an iPad, from which you'll be able to control the room's lights, sounds and elements
- With one tap on the MSE App, you can transform your room with an incredibly immersive theme. For example, pressing the blue button will transport you into the depths of the ocean your sensory resources will glow a bright blue, whales will elegantly swim across your projector screen, and the calming sounds of the sea will resonate through the speakers
- Get in touch to find out more

Y310836

£539.00

B. LED wall wash

- Using the very latest LED technology these length of LED's can be mounted on a wall or ceiling, washing an area with bright intense colours
- Can be used for theming a room or to help develop a knowledge of colour and colour recognition
- They are best used along the length of a wall
- The colours can change through the colour spectrum or can be interactive being compatible with our colour control switches
- Colour Controllers sold separately and will require a wireless remote control to power
- Price per metre

Y310825

£215.00

C. Combined MSE Genie wall wash control driver

- An App that allows you to centrally control all of your sensory equipment from an iPad. The MSE App is free and has a user-friendly interface with bright colours and large buttons to make play inclusive and accessible
- You can introduce MSE App Control into your sensory room at any point without the need for the MSE Apple TV Bundle. With the help of a few interactive receivers, you can wirelessly control all of your interactive sensory resources at the touch of a button.
- The app is available to download from the Apple App Store onto an iPhone or iPad, transforming it into an easy-to-use sensory room control system.

Y310856

£227.00

D. Combined MSE Genie app receiver

- Plugging this into your bubble tube will make it compatible with the MSE Genie app.

Y310857

£205.00



A



B



C





A. Interactive hurricane column

- A waterless beacon of colourful bubbles! Our Interactive Hurricane Tubes are great for relaxation and creating calming spaces. When used in a darkened room, the tube's lights will cycle brightly through a rainbow of colours, offering a brilliantly calming visual effect. What's best is that you can grab a colour controller and light the tube up in a colour that reflects your mood with our interactive columns.
- Our Hurricane Tubes differ from our Bubble Tubes as they are waterless. Instead of water, a fan system blows a flurry of small polystyrene balls throughout the tube, creating a similarly mesmerising visual effect. What's best is that they require less upkeep, and there's also a reduced chance of creating any mess.
- Compact and Tall: Just like The Shard, this column makes a big impression without wasting space. Its compact base makes it useful for smaller spaces, as it fits comfortably in any Sensory Room, Bedroom or Clinical environment
- A Calming Presence: The column's mesmerising LEDs perfectly complement the brilliant bubbling effects, drawing the attention of even the most distracted pair of eyes. They provide a sensory remedy for those who might be experiencing an emotional or sensory overload
- Interactive: Use colour controllers to change the tube's colours or a switch to affect the speed of the beads floating around the column
- Maintenance Free: Hurricane Tubes offer the same visual spectacle as their Bubbly counterparts, just without the water, making them a lot easier to maintain. The outside of the tube is easy to wipe clean, perfect for hospital wards or schools, where infection control is paramount
- Includes power adaptor

Great for:

Children and Adults
Distraction
Visual Stimulation
Autism
Dementia

Perfect for:

Multisensory Environments
Dark Rooms
Hospitals
Quiet Rooms
Sensory Bedrooms

Y310837	120cm	£999.00
Y310838	175cm	£1049.00



A. Interactive bubble column

- Interactive Bubble Tubes create a brilliantly bubbly, immersive, visual, tactile, and auditory experience illuminating sensory rooms, corners and spaces in beautifully stimulating sensory light! It's a particularly effective resource for children with special needs, disabilities and sensory processing disorders
- Choose to watch the bright LED lights cycle through the entire colour spectrum or take control with a colour controller and pick a colour that suits your mood Develop cause and effect skills whilst promoting colour recognition
- Tough, durable and powered by low voltage, bubble tubes can also be moved easily from space to space for simplicity of use
- **Benefits:**
 - Versatile: visual, tactile and auditory experience
 - Simple to use: all equipment is easy to operate
 - Interactive: allows the user to control their own environment
 - Effective: develops cause and effect skills
 - Powerful: promotes colour recognition
- **Applications**
 - An excellent addition to sensory rooms
 - Suitable for hospital environments
 - Designed for schools and educational establishments
 - Ideal for use in care and nursing homes.
 - Can also be used in the home
- **Suitable For:**
 - Users of all ages
 - Distraction
 - Visual, sound and touch-based stimulation
 - Calm and relaxation
 - Users with autism
 - Users needing interaction
- Explore our full Bubble Tube collection!
- Please Note: Bubble Tube Additive does not come with the purchase of our Bubble Tubes and will need to be bought separately.

Y310841	120cm	£912.00
Y310842	175cm	£999.00

B. Bubble column security bracket

- Attach the telescopic bracket to your wall to prevent movement at the top of your Bubble Tube.
- The security bracket keeps your column safe, stable and suitable for sensory play.

Y310845	£54.00
---------	--------

C. Hurricane tube security bracket

- Attach the telescopic bracket to your wall and prevent movement of the top of the Hurricane Tube.
- The security bracket keeps your tube safe, stable and suitable for sensory play.

Y310846	£55.00
---------	--------

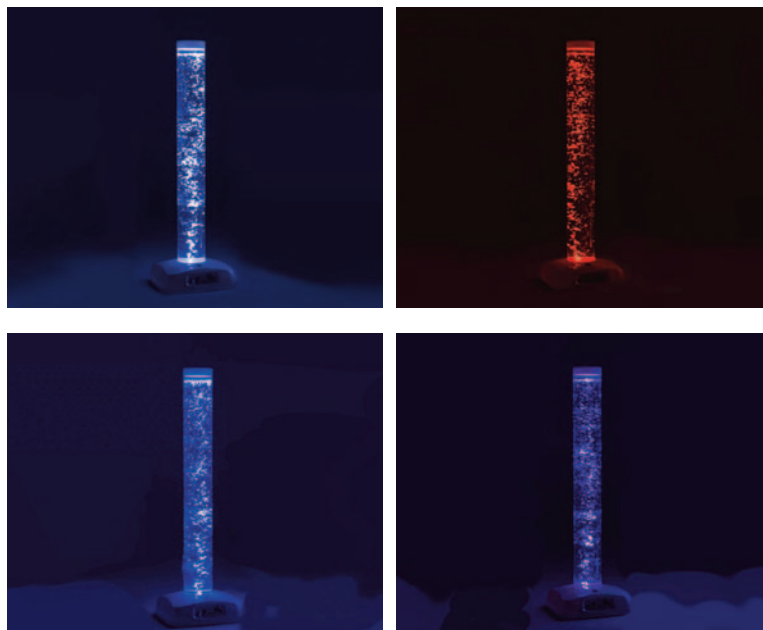

A



B

C

A



A. Bubble column additive

- Our Bubble Tube Additive helps extend your bubble tube's cleaning cycle while also protecting against infection risks

Y310801

£39.00

B



B. De-ionised water 25 litre

- De-ionised water is free from minerals and other contaminants, reducing salt build-up and corrosion inside your bubble tube and reducing the need for frequent water changes.
- 175cm Columns require approximately 45 litres of water
- With de-ionised water, you'll only have to change your bubble water every three months

Y310839

£32.00

C



C. Bubble column podiums

- A podium creates a comfortable padded seat around a Bubble Tube or a Hurricane Column, allowing users to get close and experience their senses fully.
- Podiums safely house columns behind a padded wooden base and reflect their dazzling colours and visual effects with an acrylic mirror surround.
- Built to order, our bubble tube podiums are available in a variety of colours, shapes and sizes and can be custom-made to fit your space comfortably
- Creates a stunning bubble tube experience
- Safely houses columns, keeping them safe from knocks or spills
- Built to order & available in a wide range of colours, shapes and sizes
- For more information, please get in touch with our friendly sensory team

Y310831 Square £499.00

Y310832 Corner £529.00

Y310833 Quadrant £559.00

Y310834 Large Quadrant £754.00

Y310835 Large Rectangle £725.00

Bubble walls

- An uplifting, bright, bubbling spectacular! Interactive Bubble Walls are the perfect alternative to a Bubble Tube in sensory spaces with limited floor space, as they sit directly on top of walls just like an interactive piece of art.
- Bubble Walls are portraits of imagination and relaxation. Strong, practical and easy to clean, they provide enriching visual, tactile and auditory stimulation. There's a reason why they're a must-have for any

multisensory environment.

- Interact with the Bubble Wall in the way that best suits you. Press your hands against the wall's frame and feel the soft vibrations of the bubbles, or sit back in a comfy beanbag and relax whilst watching the rainbow of everchanging colours
- **Great for:** Children and Adults, Distraction, Visual Stimulation, Autism, Dementia, Multisensory Environments, Dark Rooms, Quiet Rooms, Waiting Rooms, Namaste Rooms, Calming Rooms

A. Interactive bubble wall

- *To interact with the Bubble Wall, you'll need a colour controller cube, colour controller buttons or an MSE receiver - get in touch for more information :)
- Floating Bubbles: Bubble Walls are installed high off the ground, giving you more freedom and floor space. It's a great Bubble Column alternative for active environments and spaces with limited floor space.
- A Calming Presence: The column's mesmerising LEDs perfectly complement the brilliant bubbling effects, drawing the attention of even the most distracted pair of eyes. They provide a sensory remedy for those who might be experiencing an emotional or sensory overload.
- Robust and Easy to Clean: Bubble Walls are made from hard-wearing plastic that's great for interactive sensory sessions. It's also easy to clean, making it perfect for shared use in busy environments like hospital wards or schools where infection control is paramount.
- Interactive Art: Immerse yourself in the sensory fun by interacting with the Bubble Wall. Choose the colour of the wall and affect the speed of the bubbles.

Y310823

£1,925.00

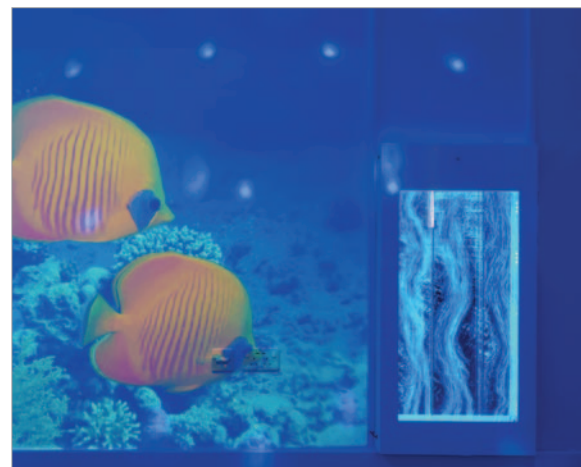

A

B. Active bubble wall

- Floating Bubbles: Bubble Walls are installed high off the ground, giving you more freedom and floor space. It can be a great alternative for a Bubble Column in spaces where floor space is limited or in more active environments.
- A Calming Presence: The column's mesmerising LEDs perfectly complement the brilliant bubbling effects, drawing the attention of even the most distracted pair of eyes. They provide a sensory remedy for those who might be experiencing an emotional or sensory overload.
- Robust and Easy to Clean: The Bubble Wall is made from hard wearing plastic that is great for interactive sensory sessions. It's also easy clean, making it perfect for shared use in busy environments like hospital wards, or schools where infection control is paramount.
- Bubbling Rainbows: The Active Bubble Wall automatically cycles through the colour spectrum, providing a rainbow of relaxing visual stimulation

Y310824

£1,595.00



B



A

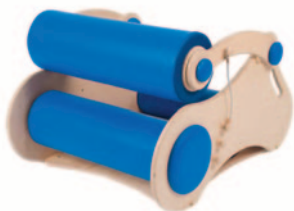

A. Body roller

- Climbing through the Body Roller's soft padded rolls provides full-body, deep-pressure therapy that's great for positioning, calming and relaxation
- Tension settings can be adjusted for ease and comfort
- Provides calming deep pressure therapy
- Rollers are fully padded, helping children relax
- Can be used for fun in soft play rooms or developmental, sensory integration sessions
- The Body Roller is available in red, green and blue

Y310829

£789.00

B



B. Cocoon

- Made from two adjustable, polystyrene-filled sides, the Cocoon offers stimulating proprioceptive pressure that's designed to calm children with Autism and Sensory Processing Disorders
- Users can lie back and relax or gently rock from side to side, therapeutically developing their sensory skills
- The inside surface is made from soft-touch suede, whilst the outer surface is made from a durable Phthalate free material with a moisture-resistant nylon inner liner
- Size: 120 x 60 x 60cm

Y310826

£249.00

C



C. Penta beanbag

- A penta shaped bean bag for ultimate comfort and versatility
- Bean Bags appeal to all ages making them feel at ease sitting in a position more common to them
- Available in a wide choice of colours and styles to make your area unique and colourful. Choose from a single colour or multi-colour - please ask for details

Y310827

£160.00

D

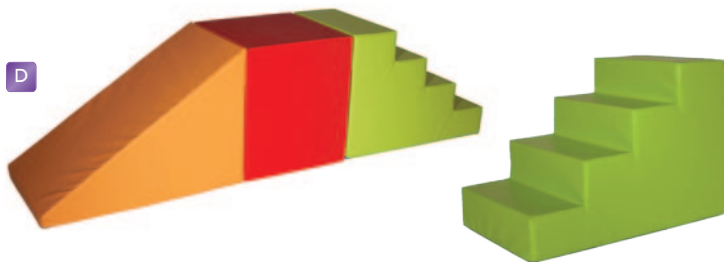

D. Soft play climbing set 1

- Comprised of bright and colourful chunky soft play stairs, a robust cube, and a wedged slide – perfect for safe climbing, jumping, sliding and fun!
- Place them together as a part of a sensory circuit, or play with each item separately as you focus on developing our vestibular, gross motor and balance skills.
- Soft Play Climbing Set 1 is great for Sensory Integration Rooms, Sensory Rooms and Soft Play Rooms.
- The soft play items are available in a wide range of sensory colours - get in touch for more information!
- Step: 100 x 60 x 68cm
- Ramp: 100 x 60 x 68cm
- Cube: 60 x 60 x 68cm

Y310828

£854.00



A. Therapy rocker chair

- Colourful vinyl-covered foam chair perfect for users seeking proprioceptive, vestibular, or motion-based stimulation
- Relaxing, therapeutic, and stimulating, they are designed to securely comfort a user from head to toe as they use their body to gently rock the chair in a rhythmic motion
- Proprioceptive Stimulation: The chair's deep seat is contoured to comfortably support the user's body from head to toe. This full-body stimulation is great for stimulating the proprioceptive system, helping the user to feel comfortable in their body.
- Stimming & Concentration: Using their body to safely rock the chair, users can find the vestibular stimulation they seek, allowing them to concentrate on what matters
- A variety of bright colours are available



A

Y310851	£1,049.00
---------	-----------

B. Folding sensory lounge chairs

- A multi-use variable seat that folds out to a relaxing and calming lounger for reading
- A unique and innovative children's seat design that folds away into a cube shape for easy, stackable storage
- Ergonomically designed for even, full-body support, excellent for children who need extra sensory input
- Made with soft touch, easy to clean vinyl, perfect for maintaining hygiene
- Durable and hardwearing with reinforced mesh-backed vinyl, ideal for a demanding school environment
- Includes a wear resistant non-slip base for added safety
- Calming, soft colours



B

Y310858	Single	£129.00
Y310859	Double	£215.00

C. Rocker seat

- A smaller, budget-friendly version of our Therapy Rocker that's as effective in providing therapeutic proprioceptive and vestibular stimulation
- Stimming & Concentration: Using their feet to safely rock the seat, users can create the vestibular stimulation that they are seeking, so they can concentrate on what matters
- A variety of bright colours are available



C

Y310822	£325.00
---------	---------

D. Rocker roller

- The rocker roller disc is an octagonal shaped softplay dome, which can be used as a rocker or turned upside down for climbing challenges



D

Y310817	£495.00
---------	---------

A



A. Textured floor tiles

- Set of six interestingly textured, foam-backed tiles that easily jigsaw together to create a stimulating sensory surface. Fluffy, furry, bumpy, hard or soft - each tile has a unique colour and texture that encourages tactile exploration and cognitive development
- We'd recommend these tiles for sensory discovery, therapeutic calming sessions and early-years play and development
- Size: Each Tile 30 x 30cm

Y310821

£39.00

B



B. 9 Bubbles mirror

- A premium quality mirror panel without a frame with 9 fascinating convex bubbles that scatter light and reflections
- Mount in ones and twos... or more!
- Excellent as a pair in the corner of the room
- Can be used outdoors if safely wall mounted in a sheltered area
- Size: 800 x 800mm

Y310816

£119.00

C

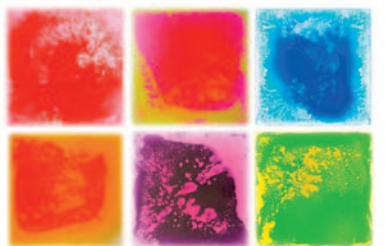

C. Liquid floor tile - square

- A terrific visual tactile treat, the bright and colourful goo locked inside each tile splats and swirls underneath your hands, feet, and wheels, creating a wicked visual effect
- The tiles work perfectly on any flat surface and can be used on top of tables for an intriguing up-close tactile session
- Every tile is made from robust materials that can withstand jumping, stomping and the weight of a wheelchair, making them perfect for inclusive group play sessions
- Size: 50 x 50cm
- Sold as single tiles, colours may vary.
- Key Features:-
 Vivid Visuals: The bright goo locked inside each tile splats and swirls underneath your hands, feet and wheels, creating a wicked visual effect.
 Accessible & Inclusive: The liquid tiles are made from robust materials that are safe for jumping, stomping, and rolling wheelchairs over. Whilst non-slip cushioned backs grip the tiles onto smoother surfaces for added stability.
- Great for: Visual stimulation, Tactile exploration, Cause & Effect, Distraction, Child & Adults, Wheelchair users, Multisensory Rooms, Schools, Public Spaces

Y310852

each £37.00

A. Convex bubble mirror

- The nine dome-shaped mirrors create an interesting optical illusion where users can see themselves reflected in fascinating ways. In addition, it challenges cognitive skills and helps users to develop their visual perception skills.
- Surrounded by colourful foam padding that's soft to touch, prevents nasty bumps and adds colour to the room
- Made from robust, shatter-resistant safety plastic that's easy to wipe clean
- Helps develop cognitive and visual perception skills through interaction with the mirror and its reflections

Y310814

£159.00



A

B. Mirror cube

- Softplay mirror cube with four soft mirrors
- Geometric shaped mirrors for early shape recognition
- Made with soft touch, easy to clean vinyl, perfect for maintaining hygiene
- Designed to encourage learning through play, building confidence and a love of learning
- Colours may vary
- Promotes development of self awareness through the use of soft mirrors

Y810860

£66.00



B

C. Getting ready cube

- Each side features a different and recognisable fastening to improve dexterity
- Features include press studs, buttons, belt, fastex buckles, zip, Velcro® and laces
- Made with soft, easy-clean vinyl, for improved hygiene
- Designed to encourage learning through play, building confidence and a love of learning
- Colours may vary.
- Helps develop fine motor skills and promotes dexterity

Y810861

£89.00



C

D. Flip sequin board

- A highly visual, tactile and creative wall panel that helps younger users explore their sense of touch whilst visually expressing themselves. Flip the sequins over to change their colour and discover the concept of cause and effect
- The board is surrounded by soft grey padding
- Made from eco-Play latex-free coated vinyl/polyester that is waterproof, anti-bacterial, fire retardant and phthalate-free
- Expect slight shedding of the panel's sequins over time
- The sequins have a silver top with a rainbow print on the reverse
- Ages 3+

Y310815

£149.00



D





Are your cloakroom and changing room areas kept tidy?
Everything to keep all your coats, bags and valuable items safe and secure around the building.

Cloakrooms & Lockers

Bespoke Cloakrooms	150-151
Candy Colours Range	152
Coat Hooks & Rails	153
Lockers	154-158
DuraStore Lockers	159
MyLockers	160-161

Cloakrooms & Lockers

Keep your cloakrooms tidy with items from our high quality range of cloakroom furniture and lockers.

Secure storage options for changing rooms, staff rooms, receptions and other open areas where valuables are kept.

Many configurations of lockers and benching, including bespoke manufacturing, providing a solution for every requirement.



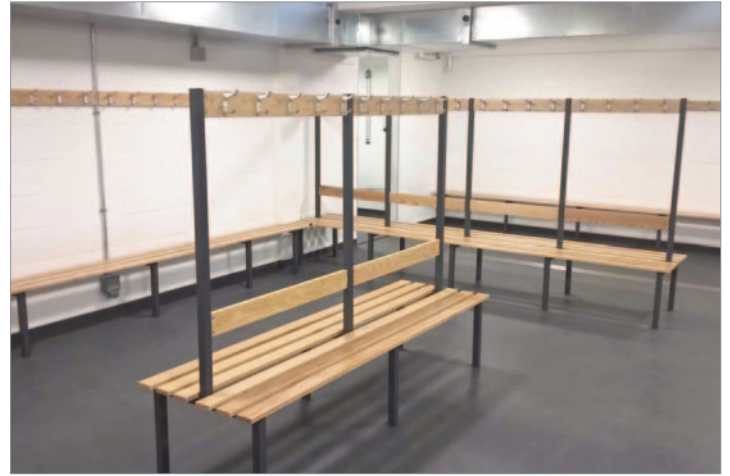
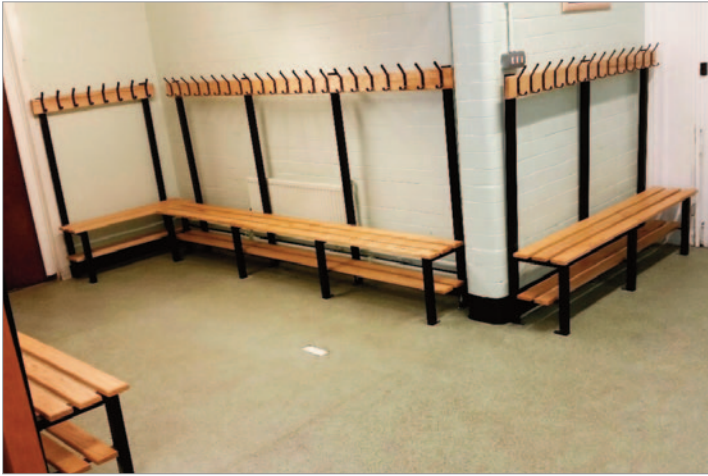

Standard Bench Options

- Black Frame, Ash Slats
- Other timber finishes available on request
- Solid Grade Laminate & Polymer slats are available at an additional price

N1

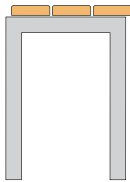

N1	1m	£165.00
N1	2m	£285.00
N1	3m	£400.00

R1



R1	1m	£140.00
R1	2m	£250.00
R1	3m	£355.00

H2

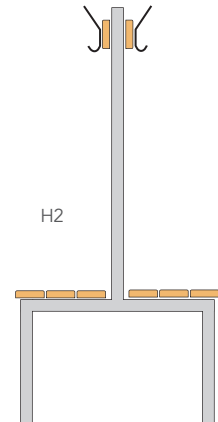

H2	1m	£415.00
H2	2m	£730.00
H2	3m	£990.00

Other standard bench options, please call for prices.

Many configurations of frames and bespoke manufacturing are available to provide a solution for every requirement.

N1S

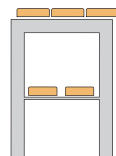

R1S

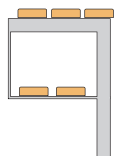

K1

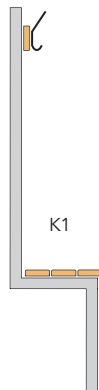

H1

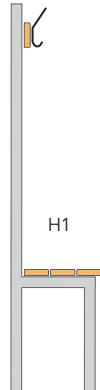

K1S

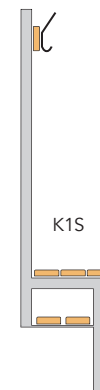

H1S

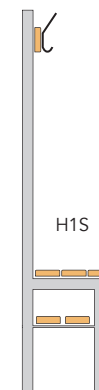

H2S

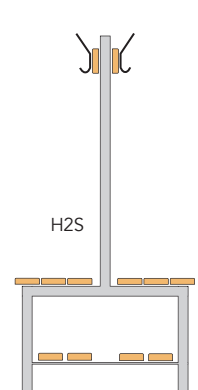

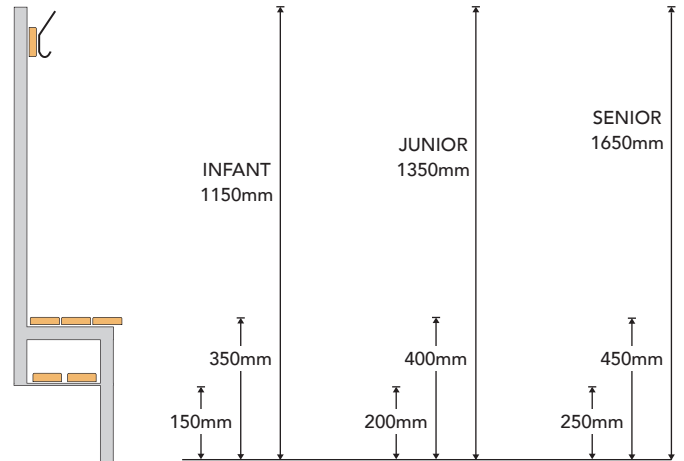

Page Link - see pages
For coat hooks → 153



- Heavy duty steel frames
- Free standing or fixed to wall/floor
- Supplied assembled or fitted on site
- Optional shoe rack

- Optional bag rack
- Optional peg rail
- Unique fold down frame for narrow corridors
- Heavy duty ash slats or solid grade laminate



Colours Cloakroom Range



- Mix & match the tops & bottoms of the cloakroom units
- Tops come complete with two height-adjustable upright bars
- All units supplied complete with Grattnell's trays within the price. See page 50 for colour and size options
- Please specify colour at time of ordering
- Choice of Beech, Maple or White

MIX & MATCH!

Use these bases as stand alone units or combine them with any of the top units shown below. Top units come with supporting upright bars.



B

A



C



D



E



F



G



H



Cloakroom bases

- Mix and match these bases with the tops shown below
- Bases supplied without upright bars
- W1360 x D345 x H455mm

A. YCLK002	4 Deep Trays	£315.00
B. YCLK004	8 Shallow Trays	£315.00
C. YCLK006	4 Open Compartments	£285.00
D. YCLK008	Boot Rack	£425.00

Cloakroom tops with upright bars

- Height adjustable
- Mix and mach with bases shown above
- Supplied with upright bars to attach to bases

E. YCLK001	8 Compartments W1360 x D170 x H410mm	£355.00
F. YCLK003	Hanging Rail W1360 x D250 x H138mm	£220.00
G. YCLK005	4 Compartments W1360 x D170 x H250mm	£285.00
H. YCLK007	8 Hooks W1360 x D40 x H200mm	£220.00

Rail Colours

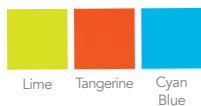

Lime Tangerine Cyan Blue

Panel Finishes



Beech Maple White



Coat Hooks & Rails

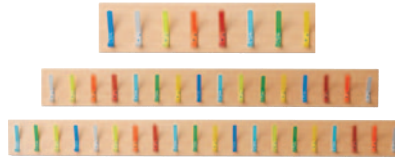

A. Coat hook rails

- Straight coat hook rails with indented space above hooks for personalisation
- Rail size W1200mm x H195mm
- Comes with 10 assorted coloured hooks
- Natural beech finish

Y91412	Beech Coat Hook Rail	£108.00
--------	----------------------	---------

B. Cloakroom hooks & rails

- Colourful metal coat hooks pre-mounted onto 180mm depth MFC boards
- Choice of 3 finishes: Beech-BE, Maple-MP or White-WH
- Hooks supplied as assorted colours, or specify single colour

320300	8 Hook Rail W1200mm	£98.00
320302	16 Hook Rail W1500mm	£118.00
320304	20 Hook Rail W1800mm	£138.00

C. Metal hooks only

- Choose from assorted pack or single colours
- Please specify colour for single colour packs
- Packs of 10

320320	Assorted Coat Hooks	£40.00
320322	Single Colour Hooks	£40.00



D. 8/16 Compartment cloakroom bench

- Cloakroom storage unit with open compartments
- 3 carcass & 9 frame finishes as below
- 8 compartment: D350 x H515 x W1200mm; compartment size W276 x D174mm
- 16 compartment: D350 x H515 x W1500mm; compartment size W166 x D174mm

320350	8 Compartment	£215.00
320352	16 Compartment	£275.00

Page Link - see pages

For bag storage

77



E. Brighthooks

- Strong and colourful plastic hooks
- Packs of 10 single colour
- Please specify colour

320330	Brighthooks	pk 10	£26.00
--------	-------------	-------	--------

Colour Range

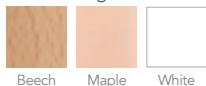

Beech Maple White

Hook & Frame Colours

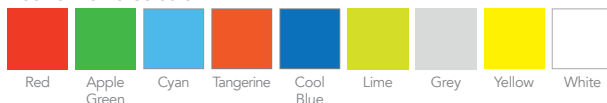

Red Apple Green Cyan Tangerine Cool Blue Lime Grey Yellow White

Brighthooks Colours

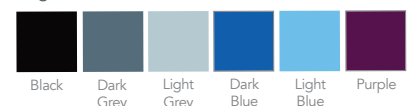

Black Dark Grey Light Grey Dark Blue Light Blue Purple

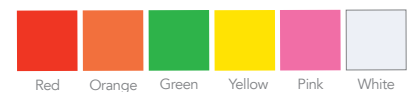

Red Orange Green Yellow Pink White



lockers with inset doors

optional Sloping top available

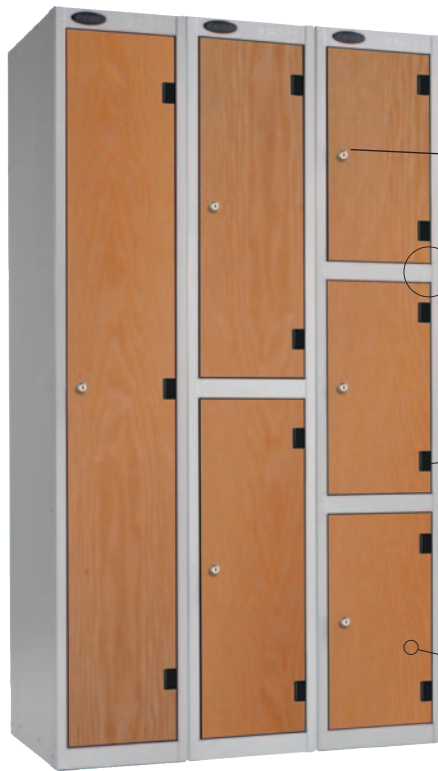

Numbering System

Available at additional cost.
Number plates will be recessed into door if ordered with lockers.

Lock Options

High Security

Compartment divider incorporates internal door stop and sill

180° Opening

This strong hinge offers 180° wide opening.

Hinge Securing Plate

This strong hinge incorporates an integral securing plate which clamps the door to the hinge giving added security.

Bioshell

Anti-bacterial technology



Available in 1, 2, 3 and 4 tier

Single and two tier doors subject to minimum quantity.

We recommend lockers are fitted to the wall for Health and Safety purposes, please contact us for an installation quotation.



lockers with overlay doors



180° Opening Hinge

This hinge offers unparalleled levels of access to each compartment making full use of clear entry.



Trespa Athlon Fire Classification

Type: Standard (Non-FR): Euroclass D-s2, d0EN 13501-1
 Type: FR (Fire Resistant): Euroclass B-s2, d0EN 13501-1
 (available at additional cost)



Laminate doors

10mm solid grade laminate inset doors.



We recommend lockers are fitted to the wall for Health and Safety purposes, please contact us for an installation quotation.

Stock Door Colours

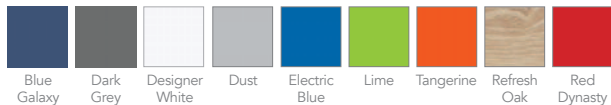

Other colours available - please ask for details



(bioshell)
anti-bacterial coating

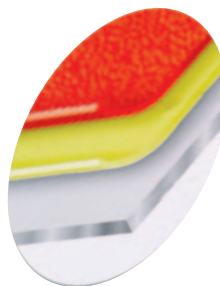

- The hard wearing anti-bacterial powder coating for the most stringent hygienic environment
- Iron Phosphate Key Coat
This anti-rust, key coat bonds to the steel in readiness for the final active coating
- Prepared Steel Surface
Chemical cleaning ensures an ideal surface for further coatings

A. Single compartment

- Including top shelf and double coat hook

Y16100*	H1800 x W300 x D300mm	POA
Y16106*	H1800 x W300 x D380mm	POA
Y16112*	H1800 x W300 x D450mm	POA
Y16118*	H1800 x W380 x D380mm	POA
Y16124*	H1800 x W450 x D450mm	POA

B. Two compartment

- Including double coat hook per compartment

Y16128*	H1800 x W300 x D300mm	POA
Y16134*	H1800 x W300 x D380mm	POA
Y16140*	H1800 x W300 x D450mm	POA
Y16146*	H1800 x W380 x D380mm	POA
Y16152*	H1800 x W450 x D450mm	POA

C. Three compartment

Y16156*	H1800 x W300 x D300mm	POA
Y16162*	H1800 x W300 x D380mm	POA
Y16168*	H1800 x W300 x D450mm	POA
Y16174*	H1800 x W450 x D450mm	POA

D. Four compartment

Y16178*	H1800 x W300 x D300mm	POA
Y16184*	H1800 x W300 x D380mm	POA
Y16190*	H1800 x W300 x D450mm	POA
Y16196*	H1800 x W380 x D380mm	POA
Y16202*	H1800 x W450 x D450mm	POA

E. Five compartment

Y16206*	H1800 x W300 x D300mm	POA
Y16212*	H1800 x W300 x D380mm	POA
Y16218*	H1800 x W300 x D450mm	POA

F. Six compartment

Y16224*	H1800 x W300 x D300mm	POA
Y16230*	H1800 x W300 x D380mm	POA
Y16236*	H1800 x W300 x D450mm	POA
Y16242*	H1800 x W380 x D380mm	POA

* Please specify colour

Call us now for our best prices!

Door colours

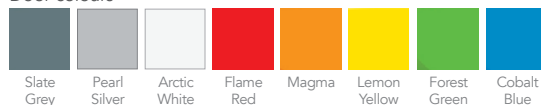

When ordering your lockers please specify:
1. nesting 2. carcass colour 3. door colour

Designer door colours

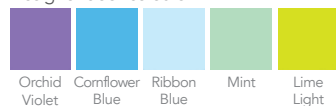

Body colours



Lockers can be supplied singularly or nested up to 3 wide

We recommend lockers are fitted to the wall for Health and Safety purposes, please contact us for an installation quotation.

We recommend lockers are fitted to the wall for Health and Safety purposes, please contact us for an installation quotation.

All lockers meet:



MEETS BS 4680:1996
excluding size specification



- All lockers come as standard with Bioshell anti-bacterial powder coating
- All plastic components used in the manufacturing incorporate a silver based anti-bacterial agent

Cam lock or Hasp & Staple supplied as standard



Cam lock with key



Hasp and Staple
(accepts padlock)

Lock options:



Combination Lock 4
Digit



Digital
Combination Lock



Coin Return Lock

- Between each compartment the locker has a plinth. This makes each compartment totally separate and increases structural rigidity



- Standard lock has a micro sprung 10 lock featuring a massive 3000 key combinations



- Vent system allows each compartment to 'breathe'



Options

- Sloping top option
- Lockerstands to raise off floor
- Numbered plate and key fob
- Masterkey
- Combination lock
- Electronic lock
- £1 coin Coin return lock

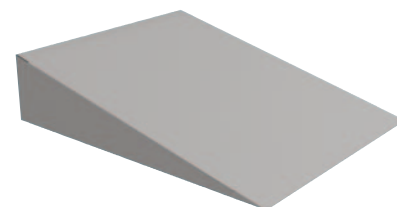

Sloping top option



Locker stands

A



A. Phone lockers

- Secure storage for phones
- Clear doors reduce user anxiety
- Charging option available
- Controlled collection and return is perfect for educational environments

YPHONL

POA

New
Product

B



B. Low lockers

- Including top shelf and double coat hook

Single Tier

Y16400L	H1200 x W300 x D300mm	POA
---------	-----------------------	-----

Y16406L	H1200 x W300 x D450mm	POA
---------	-----------------------	-----

Double Tier

Y16412L	H1200 x W300 x D300mm	POA
---------	-----------------------	-----

Y16418	H1200 x W300 x D450mm	POA
--------	-----------------------	-----

C



C. Cube lockers

Y16248	H300 x W300 x D300mm	POA
--------	----------------------	-----

Y16250	H380 x W380 x D380mm	POA
--------	----------------------	-----

Y16252L	H450 x W450 x D450mm	POA
---------	----------------------	-----

Nesting available - please ask for details

D



D. Janitors lockers

- Including double coat hook

Y16424L	H1800 x W450 x D450mm	POA
---------	-----------------------	-----



DuraStore - plastic lockers



- Strong and dent resistant
- Cannot rust
- UV resistant
- Plastic contains additive to resist bacteria, moulds & yeasts
- Recyclable
- Locker floors slope to the door and drain channels
- Quick installation - one piece unit saves assembly time
- 10 year warranty under normal use
- Frame - Grey
- Doors available in Red, Yellow, Blue, - please specify door colours and door colour order



Blue



Red



Yellow

10 Year
Warranty

Plastic lockers

For use inside buildings, including near humid areas, near showers and swimming pools.

Lockers supplied with water resistant cam lock or hasp lock.

EDPI001	4 Doors H1800 x W320 x D450mm
EDPI002	3 Doors H1800 x W320 x D450mm
EDPI003	2 Doors H1800 x W320 x D450mm
EDPI005	1 Doors H450 x W320 x D450mm
EDPI006	2 Doors H900 x W320 x D450mm

Lock options:

EDP015	Cam Lock Type 1
EDP016	Hasp & Staple Lock
EDP020**	Coin Return Lock ASSA

DuraStore options

EDP011	Sloping Top W320 x D450mm
EDP012	Engraved Number Disc
EDP013	Nesting Nuts & Bolts with Rubber Washers
EDP014	Adjustable Feet - Set of 4

Locks

EDP015
Cam LockEDP016
Hasp & StapleEDP020 Coin
Return

Call us now
for our best
prices!

We recommend lockers are fitted to the wall for Health and Safety purposes, please contact us for an installation quotation.

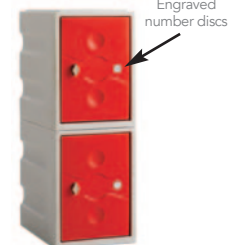

Sloping Tops

Engraved
number discs



Saving 7.5t of Co2
for every tonne reused

Anti-Bacterial Powder Coating 
An effective secondary support to existing cleaning practices

Options

- Sloping top option
- Lockerstands to raise off floor
- Numbered plate and key fob
- Masterkey
- Combination lock
- Electronic lock
- £1 coin Coin return lock



Sloping top option



Locker stands

Lockers are supplied complete with key lock. Padlock fittings can be supplied (does not include actual padlock) at no extra charge - must be specified at time of order.

550mm deep lockers available - ask for details
Special requirements eg. - Non-standard sizes, internal fittings - ask for details

We recommend lockers are fitted to the wall for Health and Safety purposes, please contact us for an installation quotation.

Mylockers

Single door locker

Code	Size (h x w x dmm)	Opening (h x w x dmm)	Single	Nest 2	Nest 3
YMY8331	1800 x 300 x 300	1410 x 235 x 275	✓	✓	✓
YMY8341	1800 x 300 x 450	1410 x 235 x 425	✓	✓	✓
YMY8441	1800 x 450 x 450	1410 x 385 x 425	✓		

Supplied with shelf and double coat hook

2 door locker

Code	Size (h x w x dmm)	Opening (h x w x dmm)	Single	Nest 2	Nest 3
YMY8332	1800 x 300 x 300	835 x 235 x 275	✓	✓	✓
YMY8342	1800 x 300 x 450	835 x 235 x 425	✓	✓	✓
YMY8442	1800 x 450 x 450	835 x 385 x 425	✓		

Supplied with double coat hook in each compartment

3 door locker

Code	Size (h x w x dmm)	Opening (h x w x dmm)	Single	Nest 2	Nest 3
YMY8333	1800 x 300 x 300	540 x 235 x 275	✓	✓	✓
YMY8343	1800 x 300 x 450	540 x 235 x 425	✓	✓	✓

Supplied with no internal fittings

4 door locker

Code	Size (h x w x dmm)	Opening (h x w x dmm)	Single	Nest 2	Nest 3
YMY8334	1800 x 300 x 300	400 x 235 x 275	✓	✓	✓
YMY8344	1800 x 300 x 450	400 x 235 x 425	✓	✓	✓
YMY8444	1800 x 450 x 450	400 x 385 x 425	✓		

Supplied with no internal fittings

5 door locker

Code	Size (h x w x dmm)	Opening (h x w x dmm)	Single	Nest 2	Nest 3
YMY8335	1800 x 300 x 300	310 x 235 x 275	✓	✓	✓
YMY8345	1800 x 300 x 450	310 x 235 x 425	✓	✓	✓

Supplied with no internal fittings

6 door locker

Code	Size (h x w x dmm)	Opening (h x w x dmm)	Single	Nest 2	Nest 3
YMY8336	1800 x 300 x 300	260 x 235 x 275	✓	✓	✓
YMY8346	1800 x 300 x 450	260 x 235 x 425	✓	✓	✓

Supplied with no internal fittings

8 door locker

Code	Size (h x w x dmm)	Opening (h x w x dmm)	Single	Nest 2	Nest 3
YMY8338	1800 x 300 x 300	185 x 235 x 275	✓	-	-
YMY8348	1800 x 300 x 450	185 x 235 x 425	✓	-	-

Supplied with no internal fittings

Mylockers

Single door low height lockers

Code	Size (h x w x dmm)	Opening (h x w x dmm)	Single	Nest 2	Nest 3
YMY13331	1370 x 300 x 300	1250 x 235 x 275	✓	✓	✓
YMY13341	1370 x 300 x 450	1250 x 235 x 425	✓	✓	✓

Supplied with a shelf and double coat hook



2 door low height lockers

Code	Size (h x w x dmm)	Opening (h x w x dmm)	Single	Nest 2	Nest 3
YMY13332	1370 x 300 x 300	610 x 235 x 275	✓	✓	✓
YMY13342	1370 x 300 x 450	610 x 235 x 425	✓	✓	✓

Supplied with double coat hook in each compartment



Special Low
Height



3 door low height lockers

Code	Size (h x w x dmm)	Opening (h x w x dmm)	Single	Nest 2	Nest 3
YMY13333	1370 x 300 x 300	400 x 235 x 275	✓	✓	✓
YMY13343	1370 x 300 x 450	400 x 235 x 425	✓	✓	✓

Supplied with no internal fittings

We recommend lockers are fitted to the wall for Health and Safety purposes, please contact us for an installation quotation.

Bridge Lockers

Bridge units

Code	Size (h x w x dmm)	Number of Compartments
YMY811AR	1800 x 1500 x 450	11
YMY818AR	1800 x 2100 x 450	19



Call us now for our best prices!

Door colour options All lockers supplied with grey carcass



Green

Dark
Blue

Red

Yellow

Dark
Grey

Grey

Black

White



Is your IT suite smart?

With space optimization and intelligent design, we can help you achieve more in less space!

IT Suites

Bespoke IT Benching Solutions	164-165
IT Poly Seating	166-169,171
IT Upholstered Seating	170
Stools	157
Flex Chair	172-173
Charge Lockers	174-175
Laptop Storage	176-177

IT Suites

When it comes to creating your ideal IT suite we can design a unique solution for your requirements.

Whatever surface, size or colour, we have a range of standard units and bespoke solutions that will meet the most demanding needs and technical requirements for the most effective IT teaching space.

From built in lap top charging units down to individual chairs, we can tailor your IT suite to your own needs and we don't stop with the delivery, we can fit them, wire them and commission on site.

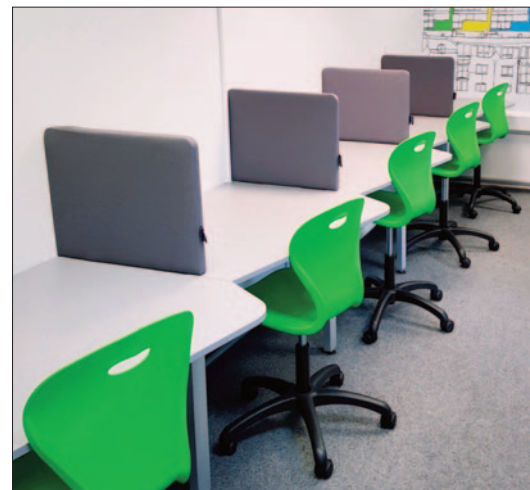

Due to limitations in the printing process, wood and colour finishes shown throughout the catalogue may not be representative of actual colour. Samples are available on request.

IT BENCHING SOLUTIONS



Ask about our
FREE space planning
& design service



Flat Panel & Goal Post Legs

Panel Leg

Heavy duty panel leg for a solid timeless look that can be scribed to fit many room requirements. Options include a full range of popular frame finishes/colours with strong matching edging for a quality finish, and additional cable management. Available in any dimension to suit your space – please enquire!



Goal Post Style Leg

Very strong and stable leg option – an adjustable style for accurate lengths in any room, provides extra cable management options. Available in a full range of popular frame finishes/colours, and any height or depth dimension to suit your space - please enquire!



IT BENCHING SOLUTIONS

Adjustable Front Legs & Cantilever Legs

Aluminium Adjustable Track Leg Benching

The ultimate benching system, with highly flexible features to suit most rooms. Incorporating clever rail systems that allow for accurate adjustment and easy reconfiguration options. Options include cable management and a range of popular frame finishes/colours. Available in a range of depths and heights to suit your space - please enquire!

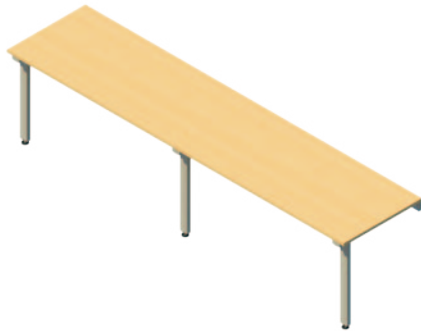

Ask about our
FREE space planning
& design service

Cantilever Leg

The cantilever leg is a strong and smart option. The desk-style leg provides good knee space and allows for modesty panel option. Other options include additional cable management as well as a full range of frame finishes/colours to match. Many height and depth options to offer – please enquire.

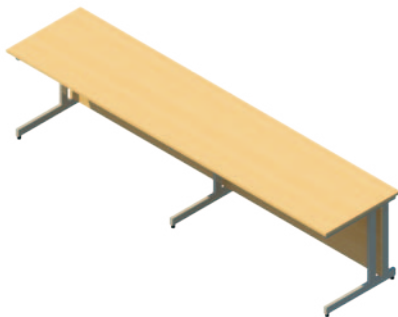

5 Year
Warranty

A



Glides Castors

A. Flow IT chair

- Virtually indestructible shell
- Tamperproof - all metal height adjustment lever
- Suitable for junior or adult use
- In stock for rapid delivery
- Seat height 390 - 520mm
- Available with glides or castors
- Small order charge applies

YENIT50	each	£94.95
---------	------	--------

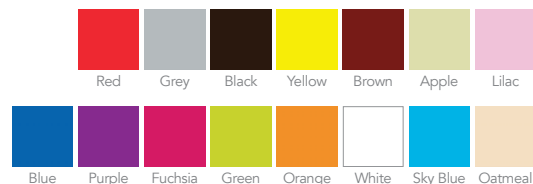

B



B. Profile swivel chair

- Profile is a modern, comfort designed, swivel chair certified for education and suitable for a wide range of applications
- Available with casters or glides
- Seat is available in a range of colours to suit the clients space
- Seat height 430-560mm
- Overall width and depth: 600 x 600mm

YCONTX2-B	With Black Nylon Base	£129.00
YCONTX2-C	With Chrome Base	£149.00

5 Year
Warranty

C



Glides Castors

C. Vogue IT chair

- Ergonomic and dynamic Swivel Chair that supports the user in all directions
- One Piece 100% Recyclable shell
- 5 Year guarantee
- Ergonomic and strength compliant to education standard
- 12 Vibrant Shell colours
- Available with castors or glides (please specify)

YVG3601	£119.00
---------	---------

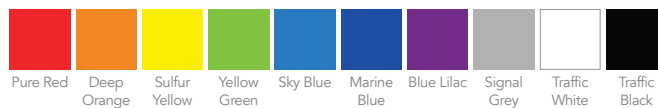

A. Positive Posture IT chair

- Stylish chair with chrome base, complements the positive posture 1 piece polypropylene chairs
- Junior colours: Green, Yellow, Red, Blue, Purple, Lime, Sky, Orange
- Additional adult colours: Grey, Charcoal, Black, Burgundy
- Fabric seat pads also available - POA
- Available with glides or castors (please specify)
- Small order charge applies

	seat height	
YPP101J Junior Height	405 - 460mm	£98.00
YPP102A Adult Height	465 - 555mm	£109.00

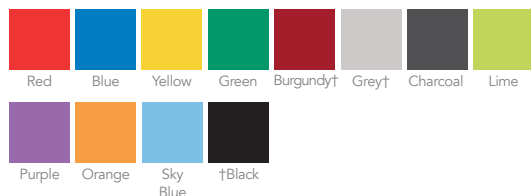

A

Phone For Bulk Prices

B. Junior small IT swivel chair

- Heavy duty junior size operator
- Built in the UK for the educational market
- Flame retardent foam
- Black 5 star base as standard
- Available with castors or glides
- Dimensions: W450 x D560 x H810mm
- Seat height range: 470-570mm
- Available in a wide range of fabrics

Y32013	POA
--------	-----



B

B. IT stool

- Available with black/chrome components
- Castors available: standard castors (as shown on image), rubber castors, brake loaded castors, manual locking castors, or glides
- A choice of 90 Advantage and Phoenix colours



Gas Lift

YITSB Standard Stool Black Base	£98.75
YITSC Chrome Base	£82.80

Phoenix, Era and Rivet fabric ranges shown on pages 288-289 or ask for a swatch.



C



- Choose
1. Colour see pages 288-291
 2. Castors or glides

5 Year
Warranty

A

Phone
For Bulk
Prices

B

5 Year
Warranty

C



Glides Castors

A. Mono posture IT chair

- Perfect ergonomics with unique waterfall seat edge and lower back lumbar design
- Flame retardant to CRIB 5, compliant to BS5852 2006
- Available in 15 colours
- Size: H395-485 x W415 x D450 x overall H760-850mm
- Available with castors or glides (please specify)
- Small order charge applies

Y32011	Mono Posture IT Chair	£85.80
--------	-----------------------	--------

* Colours available as Mono Posture stool below



Glides Castors

B. Mono posture low task stool

- Ideal for teaching assistants use in classrooms
- Perfect ergonomics with a unique waterfall seat edge
- 16 colour options
- Available with castors or glides (please specify)

Y32022	Mono Posture Low Task Stool	POA
--------	-----------------------------	-----



Glides Castors

C. Pennine swivel chair

- Innovative design for perfect postural support
- Seat back with pelvic support relieves Pressure
- Black 5 star base with Gas lift
- Seat height range of 420-555mm
- Available with castors or glides (please specify)

Y100166	Pennine Swivel Chair	£94.20
---------	----------------------	--------



Eaton task chair

- A modern multi-functional shell chair, manufactured in the UK
- A simple design formed with clean lines and subtle curves to form an ergonomic seat shape, providing flexibility of movement and comfort in a variety of different sitting positions - from upright to side on to kicking back
- Ideal for higher education, co-working and office environments
- UV resistant poly seat that is 100% recyclable
- Wide range of seat colours
- Black 5 star swivel base with castors
- Black steel armrests available as an optional extra
- Task stool has a 5 star base with glides and footrail ring
- Upholstered seat pad or full seat upholstery available – Please ask for prices and fabric options
- Overall dimensions: W600 x D600 x H625-745mm
- Seat height range: 400-520mm, stool: 600-860mm

YEATSK01	Task Chair	£195.00
YEATSKA01	Task Chair with Arms	£245.00
YEATSK05	High Task Stool	£238.00



Upholstery Options
Seat Pad only or Fully Upholstered
Please ask for prices and fabric options

Eaton Swiss task chair

- Attractive black angled 4 star swivel base (not height adjustable)
- Black steel armrests available as an optional extra
- Upholstered seat pad or full seat upholstery available – Please ask for prices and fabric options
- Dimensions: W600 x D600 x H790mm (fixed seat height 460mm)

YEASWTSK02	Task Chair	£229.00
YEASWTSK03	Task Chair with Arms	£249.00



Coral Red Signal Orange Signal Yellow May Green Pastel Blue Violet Blue Light Grey Mouse Grey Traffic White Traffic Black



Upholstery Options
Seat Pad only or Fully Upholstered
Please ask for prices and fabric options

Phone
For Bulk
Prices

A



Glides



Castors

A. IT mid back operator chair

- Medium back operator chair
- Built in the UK for the educational market
- Non marking wheels to protect floors
- Black 5 Star base as standard
- 5 year guarantee
- Dimensions: W500 x D550 x H860mm
- Seat height range: 475 - 605mm
- Available with castors or glides
- Available in 3 standard fabric colours: charcoal, royal blue and burgundy – for other fabrics POA

Y20106IT

£94.80



Charcoal Royal Blue Burgundy

Best
Seller

5 Year
Warranty

B

Colour
Options

Choose
1. Colour see pages 288-291
2. Castors or glides



Glides



Castors

B. Student IT tamperproof



- This strong and comfortable chair is proven in education, and is one of the most popular IT chairs on the market
- The seat and back are joined with two robust metal struts either side, with a very strong underseat frame and just one tough height adjustment ring
- The chair is designed and built for this purpose and offers great value for money

		Height Range	
Y15066	With Castors	400-600mm	£129.00
Y15068	With Glides	400-600mm	£98.50
YTWOT	Addn. Charge for 2-Tone Fabrics from Band 1		£18.50

Fabric ranges shown on page 288-291 or ask for a swatch

C



Glides



Castors

C. IT tamperproof operator chair

- Medium sized back operator chair with tamperproof fixings
- Built in the UK for the educational market
- Available with castors or glides – please state
- Black 5 star base
- 5 year guarantee
- Dimensions: W500 x D460 x H890mm
- Seat height range: 465 – 595mm
- Available in 3 standard fabric colours – charcoal, royal blue and burgundy
- For other fabrics POA

Y32013TP

POA



Charcoal Royal Blue Burgundy

A. Ruckus chair

- A mobile stacking chair that transforms learning space by its inspiring and innovative design
- Designed to encourage a unique sitting experience that inspires interaction with others
- Ideal for breakout and interactive learning spaces
- Large seat surface with a unique backrest/armrest that can be used as a worksurface or a perfectly balanced perch
- Lower wire bookrack as shown, for added functionality!
- Available in a range of colours to match the seat
- 24 seat colours and 31 frame finishes – the choice is yours!
- 15 year warranty
- Seat height: 455mm

YRSTK007

POA



15 Year Warranty

A

B. Mobile+ chair

- A unique, adjustable multi-functional chair designed to offer maximum comfort & ergonomic support to the user
- Integrated rotating writing tablet, dashboard and storage facilities for a cooperative and agile learning experience
- Moulded one piece flexible seat shell with a V-shaped back offering superb lumbar support
- Integrated tilt mechanism and gas lift
- Black 5 star base with castors
- Available in 10 shell colours
- 5 year warranty

YAC2W

POA

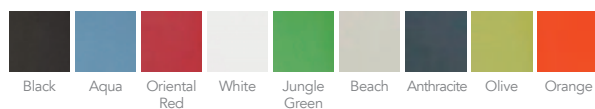

5 Year Warranty

B



T Base



Star Base

Flex Chair

- Flex is a mobile and flexible solution, allowing you to shift between various seating arrangements and learning activities easily large worksurface, adjustable to its users body and seating posture
- Large seating shell with lumbar support and flexible body
- Worksurface contains silver ions to make it 99.9% Antimicrobial

Y100720 - X base with worksurface	POA
Y100721 - X base without worksurface	POA
Y100722 - Star Base with Worksurface	POA
Y100723 - Star base without worksurface	POA

Shell Colours



Lava Spice June Avocado Navy Starlight Stone Cosmos

Flex Chair



Lecture mode

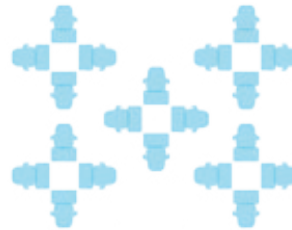

Group work mode



Discussion mode



Charge Lockers

Charging and security solutions for laptops, netbooks, tablets, Apple devices and other IT equipment.

- All charging units are CE marked (marking on a product is a manufacturer's declaration that the product complies with the essential requirements of the relevant European health, safety and environmental protection legislation)
- All doors are secured to a welded locker frame by a solid vertical rod acting as the hinge
- All the units are manufactured from 0.9 mm steel for the doors and frame and 0.7mm for the backs and sides.
- All compartments have a transparent lock cover incorporating the facility to number each door to help identification
- Each charging compartment has a rear perforated panel to allow excess heat to dissipate

Single power socket located at the rear of each compartment

A



B



C



A. 16 Compartment mobile charge trolley

YCH16M	Locker 1200 x 760 x 525mm	£2038.80
--------	---------------------------	----------

B. 15 Compartment charge

YCH15	Locker 1780 x 380 x 525mm	£795.00
-------	---------------------------	---------

C. 4 Compartment charge

YCH04	Locker 1780 x 380 x 460mm	£392.80
-------	---------------------------	---------

Door colours



Red

Blue

White

Carcass colours



White

Charge Lockers

Best
Seller



Power 2 Learn charging trolley & charging inserts

- This slim-line trolley has one of the smallest footprints in the market which makes this a perfect low cost and practical device charging option for smaller classrooms or learning areas
- The trolley can hold either 2 extra deep power trays or 3 deep power trays (see ordering options below)
- Each tray can charge a variety of USB devices in lightning fast speed using dynamic device recognition
- Lockable trolley to securely store and charge tablets and small devices
- Trays available to order separately (not recommended for secure storage of devices)
- Each tray comes with a UK socket adaptor – simply plug in, switch on and connect up to 10 USB devices to charge
- Trays available only in silver grey or white
- Steel trolley available in 5 modern bright colours: silver, white, power blue, power pink and power yellow
- W423 x D454 x H957mm (inc. handle)



YP2L102	Trolley with 2 Extra Deep Charging Trays	£928.80
YP2L103	Trolley with 3 Deep Charging Trays	£1126.80
YPTCF02	Deep Charging Tray ONLY	£262.80
YPTCF02.5	Extra Deep Charging Tray ONLY	£274.80



Power Blue White Silver Grey Power Yellow Power Pink

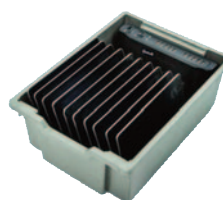

Deep Charging Tray
(Comes with Socket
Adaptor)



Extra Deep Charging
Tray (Comes With
Socket Adaptor)





Laptop Storage

Lapcabby - vertical

- 10, 15 (includes projector and printer storage), 16 and 20 port laptop trolley
- Lockable unit to securely store and recharge laptops - sequential power supply included
- Specifically designed and tested air venting system maintains the security of the unit whilst increasing ventilation
- Soft rubber grips cushion and protect laptops when in storage and large L-shaped doors and sliding shelves provide easy, clear access to laptop storage compartment

a. YLAPC10V	LapCabby 10V W616 x D703 x H1115mm	£1030.00
b. YLAPC15V	LapCabby 15V W1015 x D703 x H1115mm	£1614.00
c. YLAPC16V	LapCabby 16V W1015 x D703 x H1115mm	£1366.80
d. YLAPC20V	LapCabby 20V W1015 x D703 x H1115mm	£1546.80

Lapcabby Colours



Lapcabby - horizontal

- 16 and 32 laptop trolley
- Stored on an individual sliding tray for improved accessibility
- Lockable unit to securely store and recharge laptops - sequential power supply included
- Rear facing doors allows easy access to the individual AC adapters supplied with laptops
- The Power7 timer allows schools to program which time each day they would prefer to charge their laptops according to the class schedule or Economy 7 to reduce energy bills
- An innovative cable storage system that keeps cables compact, neat and tidy

e. YLAPC16H	LapCabby 16H W857 x D703 x H1215mm	£1750.80
f. YLAPC32H	LapCabby 32H W1291 x D703 x H1215mm	£2602.80

Laptop Storage

Lapcabby mini

- 20 and 32 port mini laptop trolley
- Lockable unit to securely store and recharge laptops - sequential power supply included
- Storage boxes available for greater protection against knocks and scrapes
- The Power7 timer allows schools to program which time each day they would prefer to charge their laptops according to the class schedule or Economy 7, to reduce energy bills
- Unique energy saving dual cables which connect to the AC adapters that are supplied with the laptops
- These cables will enable two mini laptops to charge using the same 3-pin plug
- Suitable for mini notebook laptops

a. YLAPCM20V	LapCabby 20V Mini W616 x D703 x H1115mm	£1182.00
b. YLAPCM32V	LapCabby 32V W1015 x D703 x H1115mm	£1594.80

Tabcabby

- 32 port tablet trolley
- Colourful easy-access sliding trays hold two tablets each
- Fitted with a Power7 energy management system as standard
- For added safety, AC adaptors and power supply are stored in a separate compartment - only accessible via a concealed door release
- Unique cable storage keeps cables compact, neat and tidy
- Heavy duty wheels
- Innovative air ventilation to cool tablets whilst charging
- TabCabby Store&Charge allows you to charge the majority of tablets and other USB powered devices. Using the Cambionix U16S technology you can also simultaneously synchronise all the devices whilst they are in the TabCabby

c. YTABC32H	TabCabby W840 x D437 x H1030mm	£1486.80
d. YTABSYNC32	TabCabby Sync & Charge W840 x D437 x H1030mm	£2566.80

Media-avcabby

- Designed to hold your multi-media equipment with your projector, amplifier, DVD, VCR and speakers etc. at your fingertips
- The Media-AVCabby comes complete with many features including integrated power and lockable doors which fold back a complete 270 degrees and are held in place by strong magnetic catches
- This versatile unit is manufactured from MFC with soft corners to the top and bottom and is assembled around a fully welded, powder coated steel frame, giving a sturdy unit capable of being moved easily on fully castored and braked rubber wheels

e. YMAVC200	Media-AVCabby W705 x D705 x H1105mm	£774.00
-------------	--	---------



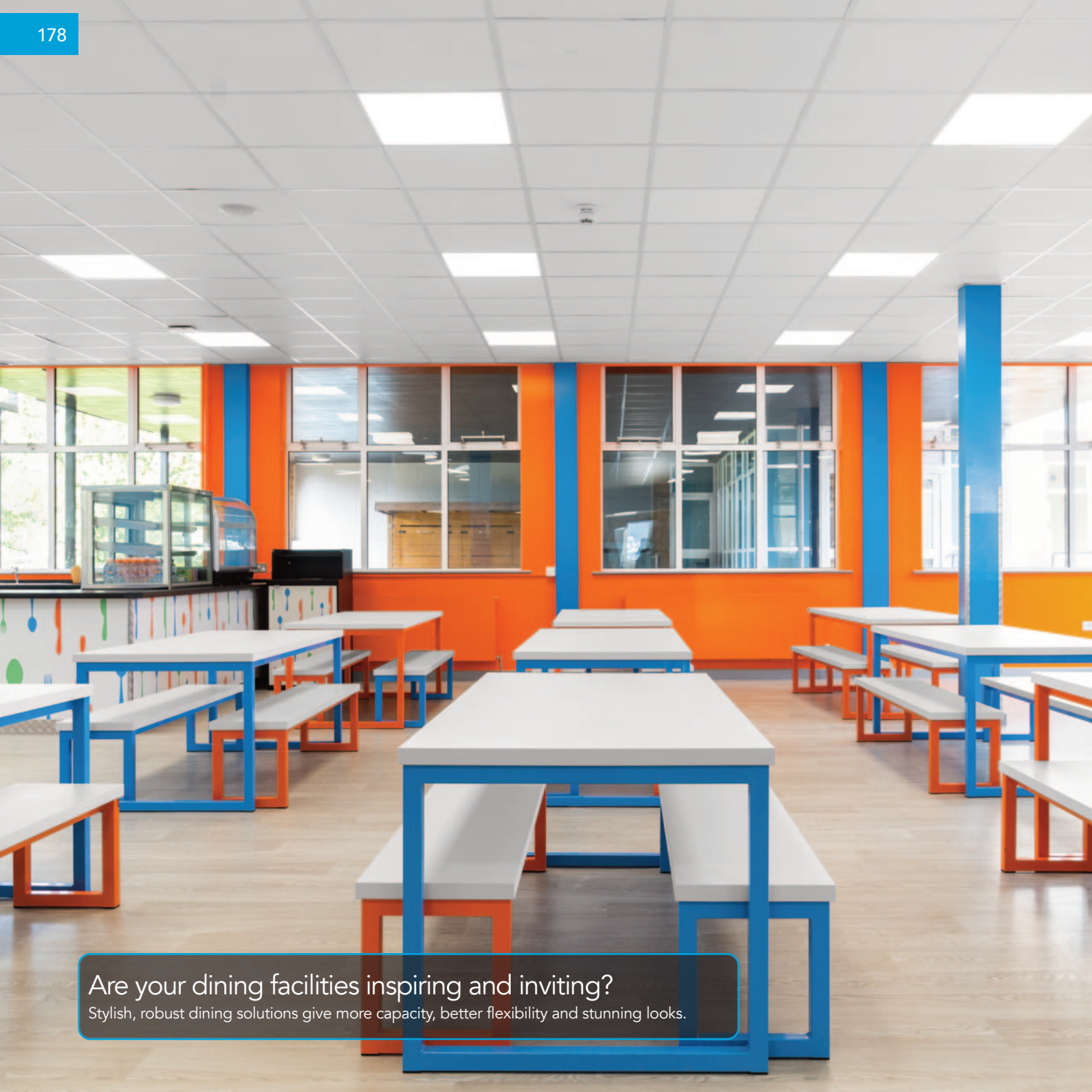

Are your dining facilities inspiring and inviting?

Stylish, robust dining solutions give more capacity, better flexibility and stunning looks.

Dining Furniture

Flip-Top Tables	180
Benchmark Folding Tables	181
Folding Tables with Stools	182
ConverTables	183
Wall Pocket Tables	184-185
Ultimate Table/Bench	186
Concept Table/Bench	187
Round Folding Tables	188
Dining Chairs	189-197
Stools	190,191,196,197
Cafe Tables	198-199
Statik Range	200

Dining Furniture

Dining areas are much more than just places to feed students. They need to be welcoming and desirable places to eat and socialise, places that students feel comfortable in and spaces that attract them.

With our extensive experience we can help you create just the right ambience that will appeal to students and staff alike.

Whether it's a modern, sleek look for a new facility or a more traditional style to suit existing surroundings, we can help you achieve just the right effect that is hygienic, effective and inspiring. Whatever your requirements, we have a feast of ideas and valuable experience!





Flip-Top Tables

- These premium quality flip-top tables are built to endure years of daily treatment
- Suitable for education environments and regular use in multi-use dining halls
- The flip-top functionality allows the tables to be easily opened and closed and wheeled away to store after use
- Supplied with four locking castors
- Available in four table heights, five frame colours and 10 laminate top colours
- The tops are well balanced, robust and reliable, with a solid 18mm MDF top with a high pressure laminate

A. 1200mm circular flip-top table

	Height	Age Range	
Y373102	640mm	8-11	£316.00
Y373104	710mm	11-14	£316.00
Y373106	760mm	14+	£316.00

B. Oval flip-top table

- 1610 x 900mm

	Height	Age Range	
Y373108	590mm	6-8	£421.50
Y373110	640mm	8-11	£421.50
Y373112	710mm	11-14	£421.50
Y373114	760mm	14+	£421.50

C. Equal octagonal flip-top table

- 1200 x 1200mm

	Height	Age Range	
Y373116	590mm	6-8	£335.00
Y373118	640mm	8-11	£335.00
Y373120	710mm	11-14	£335.00
Y373122	760mm	14+	£335.00

D. Wide octagonal flip-top table

- 1380 x 1000mm

	Height	Age Range	
Y373124	590mm	6-8	£335.00
Y373126	640mm	8-11	£335.00
Y373128	710mm	11-14	£335.00
Y373130	760mm	14+	£335.00

E. Rectangular flip-top table

- 1200 x 900mm

	Height	Age Range	
Y373132	590mm	6-8	£295.00
Y373134	640mm	8-11	£295.00
Y373136	710mm	11-14	£295.00
Y373138	760mm	14+	£295.00

F. Rectangular flip-top table

- 1500 x 900mm

	Height	Age Range	
Y373140	590mm	6-8	£349.00
Y373142	640mm	8-11	£349.00
Y373144	710mm	11-14	£349.00
Y373146	760mm	14+	£349.00



Tilt Mechanism Detail

Select:

1. Your dining table
2. Your table height
3. Your laminate top colour
4. Your frame colour
5. Your edge style

Laminate Top Colours

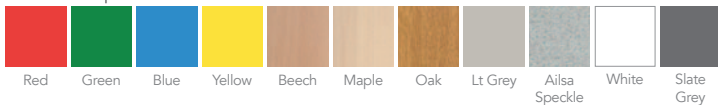

Edge Style & Colour



Frame colours



* Non returnable

Benchmark folding table with benches

- Folds flat for compact storage
- Height-adjustable
- Lift assist system
- Clears standard doorways
- Patented DoubleGuard® protects against tipping while table is being moved into storage position
- Tables nest compactly, requiring only 28cm of space centre-to-centre
- Tables feature compression spring Lift Assist for smooth, controlled operation
- Top design allows continuous end-to-end table placement
- Folded table easily clears standard door frames. Folded heights range from 1310 to 1920mm
- Edges are finished with EdgeGuard™, providing superior resistance to moisture and eliminating unsanitary food traps
- Width: Top 762mm; Bench 229mm; Total 1400mm
- 15 year warranty

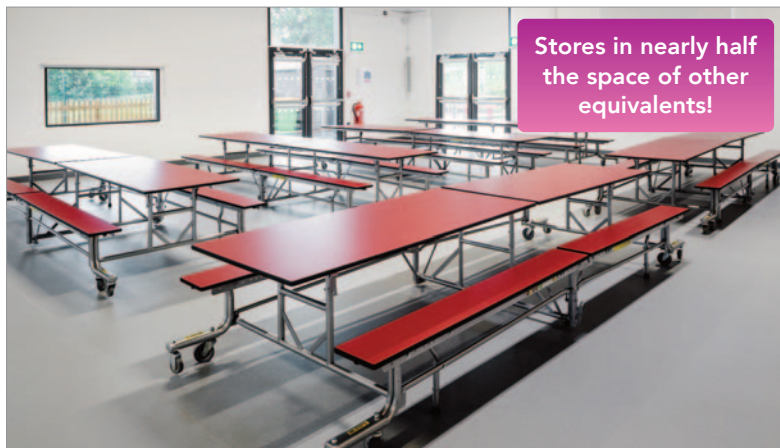

Image shows Port laminate tops – many colours available, please ask

15 Year Warranty

	Table length cm	Seat capacity	Table & Bench height cm	Folded height cm
Y16074	247	10 - 12	69/43	131
Y16076	308	12 - 14	69/43	162
Y16078	369	16 - 20	69/43	192
Y16080	247	10 - 12	74/43	131
Y16082	308	12 - 14	74/43	162
Y16084	369	16 - 20	74/43	192
Y16086	247	10 - 12	76/43	131
Y16088	308	12 - 14	76/43	162
Y16090	369	16 - 20	76/43	192

- ✓ Folds flat for compact storage
- ✓ Height-adjustable
- ✓ Seats up to 20 students
- ✓ Lift assist system
- ✓ Clears standard doorways



Add the wow factor to your dining hall. Custom graphics available.

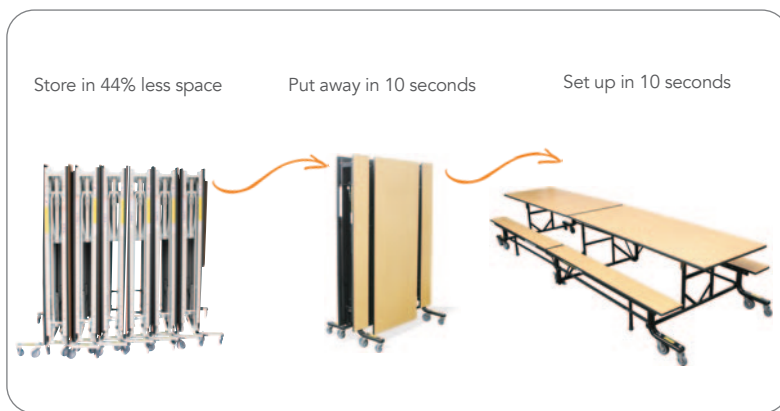

Table Colours Most popular - more available on request at no extra cost

Fusion Maple	Huntington Maple	Lapis Blue	Ocean	Dove Grey	Grey Glace	White Nebula

Frame Colours

Natural Stone	Black	Silver Metallic

Stores in nearly half the space of standard folding dining furniture

- Stores in 44% less space
- Seats up to 20 students
- Reduces lunchtime set-up



Folding dining tables with stools

- 18mm MDF core top with hard wearing high-pressure laminate surface for high endurance
- Tops have a seamless edging making them moisture resistant and resilient to damage
- All moving parts are secured with locking nuts and bolts to prevent detachment over time
- Units come with patented centre lock bar system which includes override mechanism for compact storage and transit position for safe handling and set-up
- Choice of two heights (primary and secondary) The folding rectangular table is also available with 16 stools x H650mm for infant schools only
- 14 table top colours to choose from and 11 stool colours to choose from
- 15 year warranty on welds and mechanisms and lifetime warranty on all welded parts

Folding rectangular tables

		Age Range
Y360640	With 8 Stools x H685mm	5-11
Y360642	With 8 Stools x H735mm	11+
Y360644	With 12 Stools x H685mm	5-11
Y360646	With 12 Stools x H735mm	11+
Y373150	With 16 Stools x H650mm	4-11

Folding Oval tables

Y360614	With 12 Stools x H685mm	5-11
Y360616	With 12 Stools x H735mm	11+



When ordering please specify:

1. Table colour
2. Stool colour

Stool colours



Blue Apple Yellow Green Black Blueberry Wine Orange Red Lilac Grey

Table top colours



Maple Beech Oak Red Royal White Dove Black Purple Azure Lime Orange Blue/Grey Grey Fleck

Folding round tables

		Age Range
Y360650	With 8 Stools x H685mm	5-11
Y360652	With 8 Stools x H735mm	11+

Folding Octagonal tables

		Age Range
Y360654	With 8 Stools x H685mm	5-11
Y360656	With 8 Stools x H735mm	11+

Table height guide

740mm	11 years to adult
690mm	7 to 11 years
660mm	4 to 11 years
610mm	4 to 7 years



Add the wow factor to your dining hall. Custom graphics available.



ConverTable bench tables

- Converts easily from a single-sided table to a comfortable bench. Two tables together make a full size cafeteria table
- Ideal for auditorium, lunchroom and additional classroom seating
- New 64cm high model available for early childhood applications
- Optional linking mechanism connects tables together securely.
- Dimensions – Back / Top width 38cm / Seat width 31cm
- 15 year warranty

Phone For Bulk Prices

	Table length cm	Seat capacity children	Table & Bench adult	height cm
Y16050	122	3	2	64/38
Y16052	183	4	3	64/38
Y16054	213	5	4	64/38
Y16056	244	6	5	64/38
Y16058	122	3	2	69/38
Y16060	183	4	3	69/38
Y16062	213	5	4	69/38
Y16064	244	6	5	69/38
Y16066	122	3	2	74/43
Y16068	183	4	3	74/43
Y16070	213	5	4	74/43
Y16072	244	6	5	74/43



Approximate seat widths: 406mm per child, 483mm per adult

When ordering please specify:
1. frame colour
2. table colour

Frame Colours

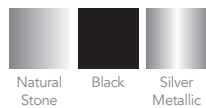

Please ask for our full colour chart at no extra charge

Table colours - more available on request

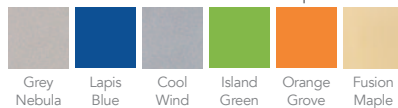

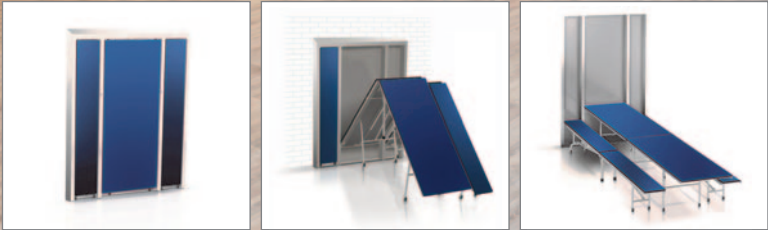

Add the wow factor to your dining hall. Custom graphics available.

Suitable for installation to existing as well as new build halls

15 Year Warranty



...to a Dining Hall
in Minutes!



Perfect for
multi-use halls!



EXCLUSIVE
IN THE UK

15 Year
Warranty

Wall pocket dining system

The perfect answer to dining furniture in multi-use school halls!

The space-saver wall pocket tables are the best solution for schools that use their halls for PE, dining and assemblies as these tables simply fold away into the walls when not in use. Seating up to 20 children per table, the wall pocket table folds down when required and it takes just seconds to convert your hall into a full dining facility.

When finished they fold away taking up less than 2½ square feet of floor space!

- Secure locks and counter-balance sprung for safety and control
- Benches and tables can be used independently for assemblies, community use, tabletop sales and lectures

- Pocket storage unit available as surface mounted or flush fitting for optimum space efficiency
- Optional filler panels between multiple units create a flat safe surface, facilitating multi-use activities
- Available as single, double, triple and quadruple pockets for up to 4 tables and 8 benches in one pocket!
- Special 'EdgeGuard' finish to table top for hygiene, strength and long life
- 15 year manufacturer's warranty
- Call for free survey, references and quote
- Customise your table tops with your school logo

Best Seller

Lifetime Warranty

A

Must be stacked vertically



When ordering your tables and benches please specify:
1. length 2. height 3. laminate colour



Lifetime Warranty

B

We recommend using B on page 188 for safe and easy transportation



A. Ultimate tables with polyedge™

The Premier range of folding tables features the superb polyurethane edge. The table top surface is durable, hygienic and of the highest quality.

- Suitable for dining, social gatherings, and community use
- Folds flat for storage and is easily transported, enabling this product to be used in a multi-functional environment
- Strong in construction, all 760mm and 685mm high tables are supplied with aluminium clad steel legs for stability
- Select the height of table you require from 6 heights
- 4 table lengths available 92cm, 122cm, 152cm, 183cm
- 3 table widths available 61cm, 69cm 76cm
- Meets BS EN1729 Part 1

Premier folding tables

	Length		Width		Approx weight kg	
	mm	Inches	mm	Inches		
Y14014*	915	36	610	24	9.00	£131.16
Y14016*	915	36	685	27	9.75	£134.53
Y14018	915	36	760	30	12.00	£139.62
Y14020	1220	48	610	24	11.25	£157.15
Y14022	1220	48	685	27	12.75	£160.56
Y14024	1220	48	760	30	13.00	£166.77
Y14026	1520	60	610	24	15.25	£173.55
Y14028	1520	60	685	27	16.50	£183.17
Y14030	1520	60	760	30	17.25	£190.51
Y14032	1830	72	610	24	17.50	£202.96
Y14034	1830	72	685	27	18.75	£206.92
Y14036	1830	72	760	30	19.50	£212.55
Y14038	FastFold Speedy Folding Table					£14.00

* Not available in height size A

B. Ultimate stacking benches with polyedge™

- Stacking benches feature the superb polyurethane smooth sealed edge for ultimate hygiene and easy cleaning
- These benches are of the highest quality and when combined with a Premier table they transform any dining area or canteen
- Meets BS EN1729 Part 1
- Available in 3 lengths 122cm, 152cm 183cm, and 3 heights 48cm, 43cm, 38cm
- Strong and robust, durable and hygienic
- Stacks for storage - use the Bench Skate Set comprising two ABS plastic moulded skates, to move your stack of benches with ease

Premier folding benches

	Length		Width		Approx weight kg	
	mm	Inches	mm	Inches		
Y14002	1220	48	254	10	6.25	£94.41
Y14004	1520	60	254	10	7.00	£112.50
Y14005	1830	72	254	10	8.80	£124.38
Y14008	Bench Skate Set				3.00	£82.50

Bench & Table Heights

When ordering, please add the height code (A-I)
e.g. code Y14014 would be Y14014B for the 698mm height.

Table heights and codes:

A	Buffet	760mm (30")
B	Adult	700mm (27.6")
C	Junior	635mm (25")
D	Infant	584mm (23")
E	PreSchool	546mm (21.5")
F	Nursery	508mm (20")

Bench heights and codes:

G	Buffet	483mm (19")
H	Adult	432mm (17")
I	Junior	381mm (15")



When ordering your tables and benches please specify:
1. length 2. height 3. laminate colour (see opposite page)

A. Concept folding tables & stacking benches

- The Concept range of folding tables and stacking benches are recommended for Dining & Canteen Halls, Youth Organisations and Outdoor Catering
- Lightweight and versatile, with a wide range of sizes available
- Meets BS EN1729 Part 1



Best Seller
Lifetime Warranty

Concept folding tables

	Length		Width		Approx weight kg	
	mm	Inches	mm	Inches		
Y14040	915	36	610	24	6.75	£98.38
Y14042	915	36	690	27	7.25	£100.63
Y14044	915	36	760	30	7.25	£104.00
Y14046	1220	48	610	24	8.00	£112.48
Y14048	1220	48	690	27	8.25	£114.77
Y14050	1220	48	760	30	9.50	£119.29
Y14052	1520	60	610	24	9.75	£120.42
Y14054	1520	60	690	27	10.25	£127.77
Y14056	1520	60	760	30	11.25	£132.28
Y14058	1830	72	480	19	11.00	£126.66
Y14060	1830	72	610	24	11.50	£139.64
Y14062	1830	72	690	27	12.00	£141.89
Y14064	1830	72	760	30	13.00	£146.41

Y14038 FastFold Speedy Folding Tool £14.00

Concept folding benches

	Length		Width		Approx weight kg	
	mm	Inches	mm	Inches		
Y14066	1220	48	254	10	5.00	£74.61
Y14068	1520	60	254	10	5.75	£84.23
Y14070	1830	72	254	10	6.75	£85.50
Y14008	Bench Skate Set				3.00	£82.50

When ordering your tables and benches please specify:
1. length 2. height 3. laminate colour



Must be stacked vertically



Bench & Table Heights
When ordering, please add the height code (A-I)
e.g. code Y14014 would be Y14014B for the 698mm height.

Table heights and codes:		Bench heights and codes:	
A Buffet	760mm (30")	G Buffet	483mm (19")
B Adult	700mm (27.6")	H Adult	432mm (17")
C Junior	635mm (25")	I Junior	381mm (15")
D Infant	584mm (23")		
E PreSchool	546mm (21.5")		
F Nursery	508mm (20")		

Phone
For Bulk
Prices



A. Round folding tables

- The Round folding tables and stacking benches are recommended for school dining, from pre-school up to adult use
- Easy to carry and open with a simple to fold clasp the tables are strong and robust, folding flat for storage
- A wide range of sizes available with 16 choices of laminate and sealed ply see page 187



Storage
Trolley

Full colour
options shown
on page 187



Colour
Options

- Choose
1. table diameter
 2. table height
 3. laminate colour see page 187

Round Folding Tables

	Table diameter	Table Finish	Approx weight	A Buffet 76cm (30")	B Adult 70cm (27.5")	C Junior 64cm (25")	D Infant 58cm (23")	E PreSchool 55cm (21.5")	F Nursery 51cm (20")	
Y14072	4ft Round	122cm	Laminate	20.00kg	•	•	•	•	•	£267.73
Y14074	5ft Round	152cm	Laminate	27.50kg	•	•				£312.84
Y14078	Storage Trolley									£461.85



B. Trolley

- Table trolleys in 2 sizes to suit all needs
- Takes up to 14 tables through a standard doorway for easy storage
- Locking castors for safety
- Please check door height clearance for small and rectangular trolleys before ordering

Y14010	Up to 7 Tables	each	£280.18
Y14012	Up to 14 Tables	each	£398.31

Only use the products on
pages 186-187 with
these trolleys

Enviro chairs

Enviro is a natural product, in a stunning range of colours, made from real wood, supplemented by additional valuable properties which are usually only provided by stone or metal. What this means for you: easy cleaning and a hardly flammable, self-extinguishing material which can even be weatherproof on request with the use of special resins.

- Stain and abrasion resistant
- Shock and break proof
- Scratch and wear resistant
- Light fast and resistant to chemicals
- 6 different seat heights 310mm to 510mm
- Made from Beech trees from stocks which are carefully replanted
- Please call for more information

YPAG7800	Sled-Base Chair
YPAG7850	4-leg Chair
YPAG7811	C-shape Chair



Size Guide

Size	Pupil Size cm	Table Height cm	Seat Height cm
2	108-121	53	31
3	119-142	59	35
4	133-159	64	38
5	146-176	71	43
6	159-188	76	46
7	174-207	82	51



Sled Base



C-Shaped



New Product



4 Legged

Select:

1. Chair type
2. Shell colour
3. Frame colour
4. Chair size

Shell Colours

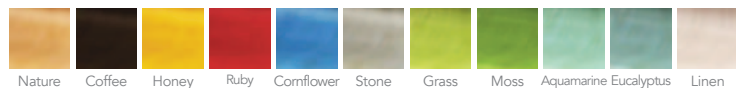

Frame Colours



A

2 Year
Warranty**A. Tuscany polypropylene dining chair & stool**

- The Tuscany brings a modern, lively look to dining and study areas, whilst the strong polypropylene seat and chrome frame are very wear resistant
- Available in 11 distinctive colours
- Stackable
- 2 year warranty

		Seat Height	
YD565	4 Leg Frame	460mm	£99.00
YD566	High Stool	760mm	£127.50

Shell Colours

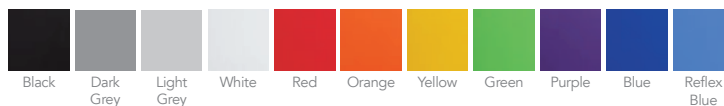

Frame Colours

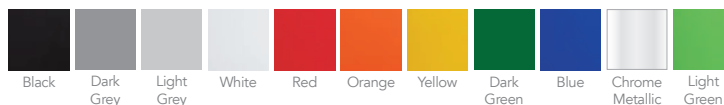
New
Product

B

**B. Highway dining chair & stool**

- Highway combines durability, comfort and style in one refined chair
- Available in 10 different colours and 8 different colours for the legs
- Laminate plywood ideal chair for soft floors

Y360352	Chair	£116.50
Y360353	Stool	£177.00

Wooden Shell Colours



Frame Colours



C

**C. Molde wooden**

- Comfortable contoured seat
- Available in Natural Oak
- Wooden Plyform seat
- Seat colours Black, White, Blue, Red, Orange, Yellow, Lime Green, Purple & anthracite

Y600610	Plyform Seat Chair	£315.00
Y600620	Plyform Seat Stool	£500.00



A. Flow dining chair & stool



A robust, durable and extremely popular chair which will work hard in your dining room giving years of dependable service. The iconic shape and chrome frame looks great and the angled rear legs discourage tilting.

- Available in 16 colours
- 125kg weight limit
- Chairs stack 6 high
- Orders of less than 6 stools may incur a carriage charge
- 15 year warranty for complete peace of mind

Chairs

		Seat Height
Y360124	Chrome Frame	460mm
Y366326	Silver Frame	460mm

High Stools

Y100125	4 Leg	610mm
Y100126	4 Leg	660mm
Y100133	Skid Frame	610mm
Y100134	Skid Frame	685mm



For critical colour matching please ask for a sample

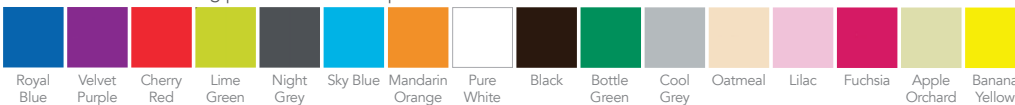



Express
Delivery

*Express delivery on
indicated colours
10-15 days

15 Year
Warranty

A. Roma chair

Roma is a contemporary and comfortable stacking chair. Stacking up to 38 chairs on a dolly, Roma really comes into its own when seating is required on a large scale. They are a popular choice for halls, meeting areas and classrooms.

- 15 year warranty
- Orders of less than 10 chairs may carry a carriage charge

		1-29	30+
Y16716	Roma Chair	£99.90	POA
Y16728	Transport Dolly	£283.80	POA
Y100310	Optional Linking Plastic Glides	£9.90	POA



Stacks up to 38 high

6 Year
Warranty



B. The Profile chair



- Modern contoured style
- Complies with EN1729 Parts 1 & 2
- Can be stacked 8 high with great stability
- Orders of less than 10 chairs may carry a carriage charge

Code	Details	Seat Height	Width	4-29	30+
Y100186	4 Legged Chair	430	480	£47.70	POA
Y100187	4 Legged Chair	460	480	£48.30	POA
Y100188	Skid Base Chair	430	530	£54.50	POA
Y100189	Skid Base Chair	460	530	£57.40	POA
Y100190	Cantilever Chair	430	530	£67.90	POA
Y100191	Cantilever Chair	460	530	£68.60	POA
Y100192	Optional Seat Pad			£26.60	POA

Shell colours:



Frame colours

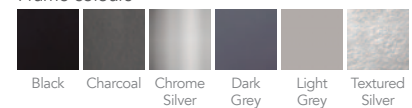

New Product

A

A. Geneva dining chair

- Strong, stable, and stackable;
- This modern side chair is perfect for outdoor use and boasts reinforced glass fibre to ensure durability
- This chair is truly versatile and can be used indoors too
- Manufactured from recyclable polypropylene
- Comes in 8 colours and stacks 4 high
- Seat height 440mm

		Seat Height
Y200200	Yellow	440
Y200202	White	440
Y200204	Red	440
Y200206	Tropical Green	440
Y200208	Dark Grey	440
Y200210	Black	440
Y200212	Orange	440
Y200214	Taupe	440



B. La rocca dining chair

- The La Rocca chair is guaranteed to bring an urban look to your dining hall with its striking elegant design
- This affordable chair is one of the strongest polypropylene chairs on the market with a steel frame that extends up the back of the chair
- Available in 7 shell colours
- Frame colours are Flint or Silver (Silver at additional cost)
- UK made with a 10-year guarantee



B

	Seat Height	Width	1-29	30+
Y360130	460mm	463mm	£49.76	POA

Shell Colours



21 Year
Warranty

A



A. Chevron chair



- One Piece Polypropylene Chair
- Streamline Design for exceptional ergonomics, comfort and a modern look
- Stronger and Lightweight - glass filled polypropylene ensures greater strength and durability, yet lighter weight
- Space Saving Stack-ability - the chair stacks easily for efficient storage, up to 21 chairs within a 2 metre height
- Slim line curved legs for pleasing aesthetics
- Sustainable Materials - uses less materials than any other chair in its class. Made from fully recyclable materials
- Stacks 21 high
- 11 Colours available
- Orders of less than 30 chairs may carry a carriage charge

	Seat Height	Overall Width	1-29	30+
Y100142	260mm	400mm	£18.90	POA
Y100143	310mm	400mm	£19.70	POA
Y100144	350mm	460mm	£21.60	POA
Y100145	380mm	460mm	£24.20	POA
Y16717	430mm	500mm	£28.20	POA
Y16718	460mm	500mm	£29.50	POA
Y100116	Linking Device		£6.60	POA

B. Trolley to take 30 chevron chairs

- Supplied flat packed for easy assembly
- Complete with ratchet strap
- Suitable for chair heights 350, 380, 430 and 460mm

Y100118	each	£159.00
---------	------	---------

For critical colour matching please ask for a sample

Royal
Blue

Sky Blue*

Lime
GreenBanana
YellowMandarin
OrangeCherry
RedVelvet
PurpleDark
GreyPure*
White

Black



Stacks 21 High

B



C



B. Oslo dining chair

- Oslo's distinct, angular design lends itself to a variety of dining settings
- Superior quality blow moulded plastic construction
- Suitable for indoor and outdoor use
- Stackable 4 high

		Seat Height	
Y360380	Oslo Dining Chair	460mm	£68.00

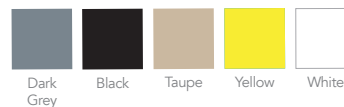
Dark
Grey

Black

Taupe

Yellow

White

A. Vivid stacking chair

- Stackable elegance for multipurpose spaces
- The elegant, streamlined silhouette of these chairs is created with a 100% recyclable, one-piece injection-moulded polypropylene/glass fibre blend.
- Its built-in UV protection makes it suitable for indoor and outdoor use
- Strong, comfortable and light
- Stackable 8 high

		Seat Height	
Y360818	Dining Chair	455mm	£39.00
Y360820	Transport Dolly		£223.00



A

Page Link - see pages

For Canopies 443



B. Stanza café chair

Looking for a little chic? You've definitely got it with Stanza!

- No screws, joints or pressure points
- Designed for maximum comfort & good lumbar support
- Made from reinforced Polypropylene with a lightly textured polymer finish
- Lightweight and easy to handle
- Easy clean and resilient
- Stacks up to 10 high
- Interior and Exterior use - UV resistant
- Available in 10 dynamic colours

		Seat Height	1-29	30+
YD995	Stanza Café Chair	460mm	£62.00	POA

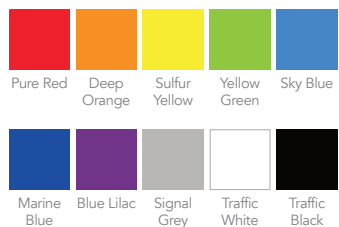

B



Also available with a Seat Pad

New
Product

A



A. Expression Stools

- A new standard by improving the aesthetic, function and sustainable role of the modern plastic stool
- Easy to use in a range of indoor and outdoor environments, décors and styles
- These stools are lightweight and can be moved around with ease
- Made from over 50% post-industrial recycled plastic in a robust, long-lasting design

Y366325	Stool	W420 x D420 x H450	£43.50
Y366326	Mid Stool	W430 x D430 x H650	£62.00
Y366327	High Stool	W450 x D450 x H750	£69.00



May Green Signal Orange Pastel Blue Violet Blue Mouse Grey Light Grey Traffic White Traffic Black

B



B. Metallique side chair

- Wanting to create a 'Costa style' dining area? The vintage Metallique range provides just that!
- Shown in Gunmetal, also available in Silver
- Low stool and high stool (without back) also available

		Seat Height	
Y366328	Side Chair	450mm	£51.00
Y366329	High Chair	745mm	£60.00

C



C. Spar dining chair

- With its iconic retro style and strong polyurethane seat the Spar chair will bring style and character to your dining space
- Available in 10 modern colours
- New mid height stool for 2019

		Seat Height	1-29	30+
YD102	Chair	450mm	£83.50	POA
Y366325	Chair Skid Frame	450mm	£87.00	POA
Y366324	Mid Stool	695mm	£107.00	POA



Black Grey Red Navy Green White Mustard Turquoise Plum

A. Skagen dining chair & stool

- With a nod towards Scandinavian style, the distinctive Skagen range combines wood and steel to create a robust and elegant addition to your dining area
- Available in Black or Natural
- Available in 3 dining heights

		Seat Height	
Y366318	Dining Chair, Ash	480mm	£102.50
Y366338	Dining Chair, Black	480mm	£102.50
Y366319	Mid Stool, Ash	650mm	£123.00
Y366339	Mid Stool, Black	650mm	£123.00
Y366320	High Stool, Ash	750mm	£134.00
Y366340	High Stool, Black	750mm	£134.00



A

B. Ermington dining chair

- The Ermington adds a sophisticated look to any dining area with its one-piece shell and chrome frame
- 4-leg Chrome version stacks up to 6
- Frames in Steel, Chrome or Black (spar leg only)
- Maple or Wenge Veneer

		Seat Height	1-29	30+
YD303	Dining Chair	460mm	£68.00	POA

Veneer finishes



Maple Wenge

Leg finishes



Steel Chrome Black



B

C. Harlen

- Harlen is a superior quality dining chair designed to evoke café vibes
- Crafted from a black steel frame for ultimate durability
- Top-quality oak veneered plywood shell seat and backrest

		Seat Height	
Y360384	Dining Chair	460mm	£156.50
Y360386	Dining Stool	780mm	£205.00



C

Barletta café dining tables

- These robust and elegant tables look great in any dining setting and are sure to add a café feel in any dining area
- Heavy bases ensure good stability in high footfall areas
- 25mm thick MFC core top with impact resistant edge
- The tops are available in eight colours
- The café dining chairs come in standard 755mm height which includes the tabletop
- Easy clean surface
- For ultimate durability why not upgrade to the Werzalit table tops – please ask for more details



Finishes

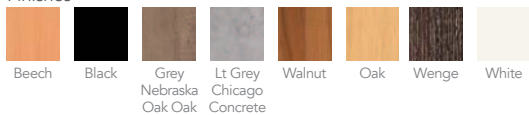

Black cast square dining base

Y370110	600 x 600mm Square Top	£207.59
Y370112	700 x 700mm Square Top	£237.02
Y370114	800 x 800mm Square Top	£296.80

Black cast rectangular dining base

Y370116	1200 x 700mm Rectangular Top	£276.64
Y370118	1500 x 700mm Rectangular Top	£301.13

Black cast trumpet dining base

Y370120	600mm Round Top	£208.63
Y370122	700mm Round Top	£236.43
Y370124	800mm Round Top	£296.14
Y370330	1000mm Round Top	£304.95

Stainless steel square dining base

Y370138	600 x 600mm Square Top	£259.46
Y370140	700 x 700mm Square Top	£330.68
Y370142	800 x 800mm Square Top	£390.91

Stainless steel rectangular dining base

Y370144	1200 x 700mm Rectangular Top	£398.27
Y370146	1500 x 700mm Rectangular Top	£422.73

Stainless steel trumpet dining base

Y370148	600mm Round Top	£282.00
Y370150	700mm Round Top	£347.46
Y370152	800mm Round Top	£406.88
Y370332	1000mm Round Top	£369.00

Black cast spar 4-leg dining base

Y370300	600 x 600mm Square Top	£207.17
Y370302	700 x 700mm Square Top	£221.13
Y370304	800 x 800mm Square Top	£281.17

Y370306	600mm Round Top	£207.07
Y370308	700mm Round Top	£221.50
Y370310	800mm Round Top	£281.38

Flip-top black cast spar 4-leg dining base

Y370312	600 x 600mm Square Top	£237.21
Y370314	700 x 700mm Square Top	£251.17
Y370316	800 x 800mm Square Top	£311.23

Y370318	600mm Round Top	£237.32
Y370320	700mm Round Top	£251.37
Y370322	800mm Round Top	£310.75



See our Wilmington tables on pages 330-331





Leg Finishes



White Silver Graphite Black Raw

MFC Finishes



Beech Maple Oak Walnut Light Grey White Black Comina Ash Boston Concrete Shorewood Whitewood

A. Statik hoop dining range

- The Statik Hoop dining range is a contemporary yet practical solution for modern dining environments
- Fully welded frame construction with 40mm thick tops and high impact resistant edges
- Easy clean laminate surfaces
- Benches store neatly under the tables for compact storage
- Many colour options available - please ask
- Upholstered seats available at extra cost

Benches

Y360418	H425 x L1000 x D350mm
Y360420	H425 x L1200 x D350mm
Y360422	H425 x L1400 x D350mm
Y360424	H425 x L1600 x D350mm
Y360426	H425 x L1800 x D350mm
Y360428	H425 x L2000 x D350mm

Tables

Y360400	H750 x L1200 x D800mm
Y360402	H750 x L1400 x D800mm
Y360404	H750 x L1600 x D800mm
Y360406	H750 x L1800 x D800mm
Y360408	H750 x L2000 x D800mm

Poseur Tables

Y360412	H1000 x L1600 x D800mm
Y360414	H1000 x L1800 x D800mm
Y360416	H1000 x L2000 x D800mm

Planning a dining room refurbishment? Let us inspire you with our **Interior Design** service



The high traffic volume and rigorous daily use of the school dining hall require a durable and timeless design.

Our talented interior design team have many years of experience creating school dining spaces that are both inspirational and functional. We'll work with you to create a space that exceeds your expectations, not your budget.





Needing to cater for everyone in your library?

We can beautifully display your books and store those resources - whilst creating areas for relaxed reading and inspiring learning areas.

Libraries & Learning Zones

Projects	204
Dynamix Shelving	205
Cantilever Shelving	206
Coniston Shelving	207
Grasmere Book Storage	207
Kandi Range	208-209
Book Storage Units	210-211
Book Spinner & Kinderboxes	212
Easy Seating	212-217
Study Hubs	218-219

Libraries & Learning Zones

Libraries are fast becoming much more than just a place to display books. With the rise of self-directed learning and personalised study programmes, libraries and learning zones are often the central feature of the school.

From group activities right through to individual study we have a full range of furniture, shelving and seating to create the perfect environment for you.

Whether its bespoke or from stock, you'll be amazed at the ideas we'll come up with based on solid experience combined with creativity and design flair. Zones to take your breath away!





Re-thinking your library or learning zones?

Let our designers demonstrate what we could do with your library or learning zone. Make your library a magnet for learners who want to be high achievers. Create an atmosphere conducive to serious study and let us design something that will stand out among other nearby schools.

Our talented interior design team will develop 3D and 4D visuals to bring your new space to life. They'll help you to create a space that exceeds your expectations but not your budget.



Dynamix Library System



Stunning units with coloured edges and tops, the Dynamix range creates an impressive and stimulating library and learning environment.

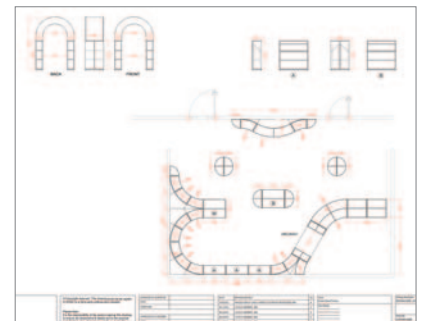
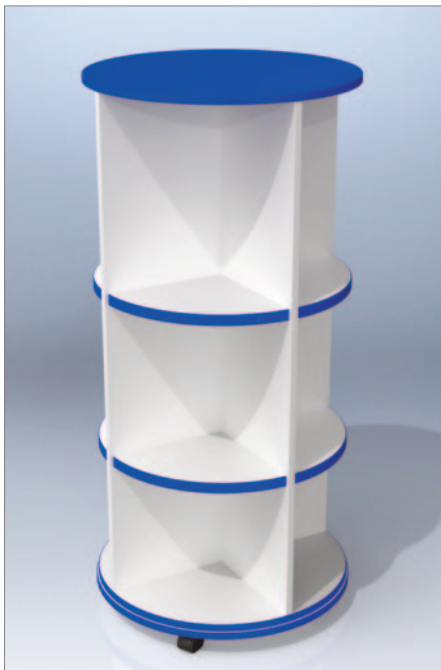
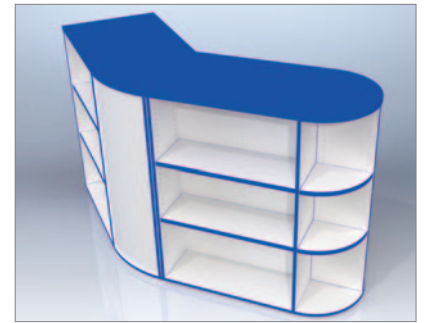



Cantilever Shelving

- This versatile shelving system offers a wide range of shelves, on-shelf and signage accessories - ideal for all library and office requirements
- Modern, stylish and robust, this cost-effective system can be quickly adapted to meet your changing needs
- The system is quick and easy to construct saving down time and minimising disturbance
- Single-sided and double-sided shelving available
- Lockable castors are available to allow the shelving to be moved around the library whilst still offer stability
- Colour combinations offer huge versatility and endless possibilities
- Space planning and fitting also available
- Designed and manufactured in the UK

Single / double sided shelving

- Heights: 1200mm | 1500mm | 1800mm | 2100mm | 2300mm
- Depths: 200mm | 250mm | 300mm | 350mm
- Widths: 750mm | 900mm | 1000mm

Standard Finishes



White



Pale Grey



UK MADE

Premium Finishes



Blue



Yellow



Red



Purple



Green



Sapphire



Silver Grey



Smoke White



Graphite Grey



Black

End panel options

- End panel options can be used to define space, enhance the display, add colour or custom graphics to brand your library. A broad range of finishes are available, giving a choice of wood effect, laminate, mfc or paint coated. Please contact us for more information

**CONTACT US TO DISCUSS YOUR
SHELVING REQUIREMENTS**

Coniston Library Shelving

Coniston is a high quality range of shelving units, available in a choice of 8 colours, specifically designed to create practical and aesthetically pleasing learning environments.

- All units can be supplied in one colour or a combination, as shown
- Units can also be supplied with castors
- Available as single or double sided units and also starter units and add-on units to create a neat and uniform library area
- Complete with 5 year guarantee



Wood & colour finishes may not be representative of actual colours - please ask for a sample



Grasmere Curve Book Storage System

- Premium range made from high quality 18mm MFC in a choice of board finishes with cream back boards
- Choice of either single sided bookcases in 2 heights, or double sided mobile units in 3 different heights
- Other board finishes available - please ask for pricing and details

Wood & colour finishes may not be representative of actual colours - please ask for a sample



A. Grasmere straight bookcase

- Single sided
- Depth 320mm

	H x W (mm)	
Y200600	900 x 1000	£370.50
Y200604	900 x 600	£331.00



B. Grasmere straight bookcase

- Double sided
- Depth 600mm

	H x W (mm)	
Y200610	900 x 1000	£517.00
Y200612	1200 x 1000	£670.50
Y200614	1500 x 1000	£789.50
Y200616	900 x 600	£430.00
Y200618	1200 x 600	£591.00
Y200620	1500 x 600	£663.00



C. Grasmere curved bookcase

- Single sided
- Choice of concave - curves inwards or convex - curves outwards
- Max. depth 835, width 1180mm

		H (mm)	
Y200630	Convex	900	£555.00
Y200632	Concave	900	£555.00
Y200634	Convex	1200	£658.00
Y200636	Concave	1200	£658.00



D. Grasmere curved bookcase

- Double sided
- Max. depth 1115 x width 1575mm

		H (mm)	
Y200640	Convex	900	£719.50
Y200642	Convex	1200	£936.50
Y200644	Convex	1500	£1245.00
Y200646	Concave	900	£719.50
Y200648	Concave	1200	£936.50
Y200650	Concave	1500	£1245.00



Y400096



Y400098



Y400100



Y400102



Y400104



Y400106



Y400108



Y400110

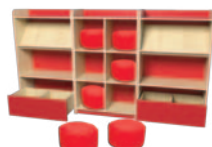

Y400112



Y400114



Y400115

Kandi Wood Options



White Maple Beech

Kandi Upholstery Colour Options



Apple Cobalt Blue Fuschia Lemon Red Orange Turquoise Violet

Kandi Theme Colour Options



Sage Red Blue Plum Fjord Green Graphite Jaffa Powder Blue Lilac Lime Stone Grey

Kandi

The Kandi range allows you to create an instant library or reading corner in any space. Mix and match units to create immersive student areas. Available in 7 bright colours and 2 wood finishes.

Y400096	Curved Book Case Set H1500 x D3200mm	£2359.50
Y400098	Curved Book Case Set with Seat H1500 x D3200mm	£3018.00
Y400100	Island Set H1500 x W1450 x D350mm	£1976.50
Y400102	Reading Straight Set H1500 x W1450 x D350mm	£909.00
Y400104	Reading Corner Set H1500 x W1465 x D1465mm	£1829.00
Y400106	Book Tree Oval H1500 x W900 x D320mm	£358.00
Y400108	Book Tree Triangle H1500 x W900 x D320mm	£358.00
Y400110	Display & Browse set H1250 x W2250 x D350mm	£1234.50
Y400112	Display & Browse with Stools set H1250 x W2250 x D350mm	£1593.50
Y400114	Reading Nook H1500 x W2700 x D676mm	£2075.50
Y400115	Book Browsing Centre Set H750 x W2250 x D500mm	£1055.00
Y400116	Hideaway Play Nook H1250 x W1700 x D676mm	£1452.00
Y400118	Hideaway Double Nook H1250 x W2100 x D676mm	£1594.00

NB. For safety reasons, library units should be fixed back to the walls

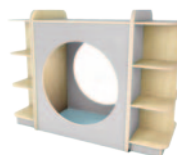

Y400116



Y400118

A. Double D-end cap bookcases

- W676 x D350mm
- Fixed shelves



Y404002	750mm High	£280.50
Y404004	1000mm High	£315.50
Y404006	1250mm High	£346.00
Y404008	1500mm High	£369.50
Y404010	1750mm High	£393.00
Y404012	2000mm High	£428.00



A

B. Reading bench

Set includes:

- 2 x 1500mm bookcase
- 1 x reading bench with seat pad
- 3 x cube soft seats
- H 750 x W 2734 x D 350mm



Y404014	Reading Bench	£1112.50
---------	---------------	----------



B

C. Double book browsers

- W 750 x D 400 mm



Y404016	Lower Book Browser	£184.50
Y404018	Tall Book Browser	£222.00



C

D. Library end bookcases

- Fixed shelves



Left

Y404020	750mm High	£233.50
Y404022	1000mm High	£245.00
Y404024	1250mm High	£257.00
Y404026	1500mm High	£268.50
Y404028	1750mm High	£280.50
Y404030	2000mm High	£292.00

Right

Y404032	750mm High	£233.50
Y404034	1000mm High	£245.00
Y404036	250mm High	£257.00
Y404038	1500mm High	£268.50
Y404040	1750mm High	£280.50
Y404042	2000mm High	£292.00



D



A. Tiered shelf library unit

- In a choice of Beech-BE, or Maple-MP MFC finish
- Dimensions: W760 x D380mm
- 4 tier H780mm, 5 tier H965mm

Y15092	4 Tier Unit	each	£279.00
Y15094	5 Tier Unit	each	£315.00

A



B. Straight shelf library unit

- In a choice of Beech-BE, or Maple-MP MFC finish
- Dimensions: W1040 x D502mm
- 3 tier H1000mm, 4 tier H1500mm

Y15096	3 Tier Unit	each	£235.00
Y15098	4 Tier Unit	each	£287.00

B



C. 2 & 3 shelf library units

- Popular double sided Beech units
- 2 shelf unit has 2 angled display shelves each side, and a flat storage shelf
- The 3 shelf unit has 3 flat storage shelves either side
- W1040 x D500 x H850mm

Y15106	2 Shelf Unit	£262.00
Y15114	3 Shelf Unit	£284.00

C



A. Library unit with 3 straight shelves on both sides

- W 1044 x D 502 x H 883 mm



Y406002	Cyan	£243.00
Y406004	Pink	£243.00
Y406006	Lime	£243.00
Y406008	Orange	£243.00



A

B. Library unit with 2 angled & 1 horizontal shelf on both sides

- W 1044 x D 502 x H 883 mm



Y406010	Cyan	£231.50
Y406012	Pink	£231.50
Y406014	Lime	£231.50
Y406016	Orange	£231.50



B

C. Double sided library unit with 3 tiered fixed shelves on both sides

- W 760 x D 760 x H 650 mm



Y406018	Cyan	£289.00
Y406020	Pink	£289.00
Y406022	Lime	£289.00
Y406024	Orange	£289.00



C

D. Single sided library unit with 4 tiered fixed shelves

- W 760 x D 380 x H 780 mm



Y406026	Cyan	£209.00
Y406028	Pink	£209.00
Y406030	Lime	£209.00
Y406032	Orange	£209.00



D

E. Single sided library unit with 2 fixed straight shelves

- W 1040 x D 502 x H 1000 mm



Y406034	Cyan	£228.00
Y406036	Pink	£228.00
Y406038	Lime	£228.00
Y406040	Orange	£228.00



E

A

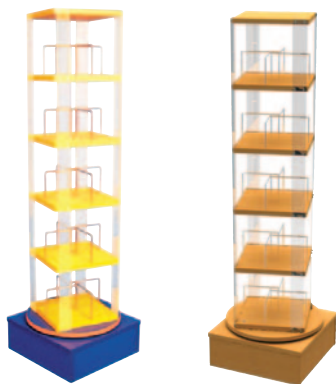

A. Book spinner

- This smaller version of an adult paperback tower holds 125 books or 60 videos
- The tower and base can be chosen in two different colours to create your own multi-coloured unit
- Please specify the base and tower colours when ordering the coloured book spinner
- Size: W400 x D400 x H1350mm
- Internal slot height: 220mm
- Dimensions for book space between dividers: 115 x 115mm

Y15110	Book Spinner Beech	£383.70
Y15112	Book Spinner Coloured	£417.42

B



B. 4 legged kinderbox

- Wooden or metal 4 legged frame 4 kinderbox unit
- Boxes available in beech, red, green, yellow or blue finish
- Wooden frame: D620 x W620 x H360mm
- Metal frame: D600 x W600 x H360mm
- Bespoke sizes and shapes available

YBX05W	Wooden Frame Kinderbox	£224.73
--------	------------------------	---------



UK MADE

5 Year
Warranty

C



C. Aspect modular vinyl range

- A flexible range of modular seating perfect for libraries and breakout areas
- Fully upholstered modular furniture with deep cushions for comfort
- Matching table with oak look or glass top
- Seat: H400 x W575mm
- Available in: Vinyl band 4

YREC25WW	Chair	£251.00
YREC26WW	Chair Left Arm	£314.00
YREC27WW	Chair Right Arm	£314.00
YREC28WW	Arm Chair	£405.00
YREC29WW	Two Seater Arm Chair	£675.00
YREC31WW	Corner Seat	£280.50
YREC32WW	30 Deg. Internal Link	£299.50
YREC33WW	60 Deg. External Link	£296.50
YREC32LWW	30 Deg. Internal Link With Left Arm	£376.00
YREC32RWW	30 Deg. Internal Link With Right Arm	£376.00
YREC33LWW	60 Deg. External Link With Left Arm	£373.00
YREC33RWW	60 Deg. External Link With Right Arm	£373.00
YREC04WW	Vinyl Oak Top Table	£188.00
YREC04GV	Vinyl Glass Top Table	£194.50

Please specify fabric colour

Page Link - see page

Vinyl
Colour
Options

291



Verve

The opportunities are endless with the Verve range - simply intertwine pieces to create a unique, creative library or learning area. Verve units are chunky, very comfortable and available in H250, H450 or H650mm. Prices shown are for H450mm. Other configurations available, please just ask!

Y400120	Verve One Seater
Y400122	Verve Two Seater
Y400124	Verve Three Seater
Y400126	Verve Five Seater
Y400128	Verve Join Three Seater
Y400130	Verve Join Four Seater
Y400132	Verve Join Five Seater
Y400134	Verve Join Six Seater
Y400136	Verve Join Three Seater Pod



Y400120

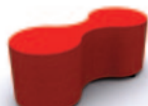

Y400122



Y400124

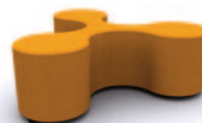

Y400136



Y400132

Causeway

- These irregular hexagonal form seats are available in 2 heights that serve as both sitting and backrest units
- Can be freely combined in infinite arrangements
- Ideal for chillout zones, waiting areas and entrance halls
- Connected with black, powder coated metal links

YCWAYHU	High Unit (750mm)	£355.00
YCWAYLU	Low Unit (450mm)	£274.00
Y400260	Side Table	£250.00



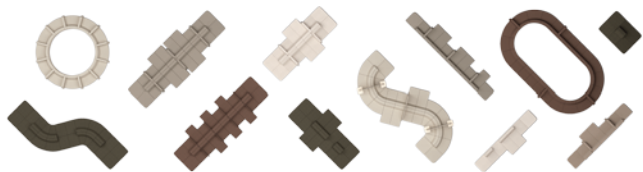

Iconic

- This flexible modular system consisting of a series of lounge seaters available in different sizes and forms. These modules can be easily combined or rearranged to make efficient use of the space
- These lounge seaters blend subtly into all kinds of lounge or workspaces for both public and private use and help to create a welcoming, safe and calm atmosphere for relaxation, informal meetings, collaborative or individual tasks
- The armrests furniture has in-built power sockets or fast charging USB (Type A+C) ports
- Upholstered in a wide range of fabrics, leathers, faux leathers, and colours



Please call for more information



Huddle

Huddle is a statement modular furniture collection that facilitates a multitude of ways to work via the creation of configurable and connected spaces. It is an innovative system designed to enable spaces to flex and adapt using easy to assemble modules to configure different shapes, making each space unique to the needs of the environment.

- The Huddle collection is based on four modular components: backs, benches, screens and work rails
- Available with integrated technology including power modules and WIFI
- These modules can be curved or straight and are available in a choice of widths; with or without legs
- Integral work surfaces and tables are optional
- Available in a wide range of fabrics, vinyls and leathers

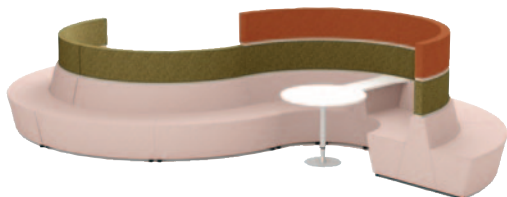

Y369810 Configuration 1

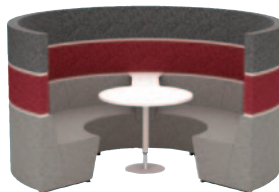

Y369812 Configuration 2



Y369814 Configuration 3

Readingzone



- Ideal for library areas, receptions, common rooms, in fact they fit anywhere!
- Seat height 440mm
- Please call for bulk discounts



Unlimited fabrics available

Prices shown are for Phoenix, Era and Rivet fabrics only - see pages 288-289. Please contact us for prices on other fabrics.



Best Seller
5 Year Warranty



Round stool

- H440 X D400mm

YSTYROF*	Fabric	£235.50
YSTYROV*	Vinyl	£251.00



Square stool

- H440 X W400 X D400mm

YSTYSQF*	Fabric	£237.50
YSTYSQV*	Vinyl	£252.00



Two seater bench

- H440 X W800 X D400mm

YSTY2F*	Fabric	£275.00
YSTY2V*	Vinyl	£298.00

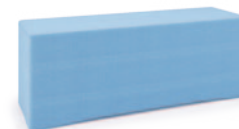

Three seater bench

- H440 X W1200 X D400mm

YSTY3F*	Fabric	£329.00
YSTY3V*	Vinyl	£356.00



Oval stool

- H440 X W780 X D400mm

YSTYOVF*	Fabric	£282.50
YSTYOVV*	Vinyl	£291.00



Wedge stool

- H440 X W530/400 X D400mm

YSTYWGF*	Fabric	£224.00
YSTYWGV*	Vinyl	£244.00



Quadrant stool

- H440 X W 860 X D400mm

YSTYQUF*	Fabric	£292.00
YSTYQUV*	Vinyl	£314.00



Tangent stool

- H440 X W790 X D400mm

YSTYTGF*	Fabric	£367.50
YSTYTGv*	Vinyl	£373.50

Page Link - see page

Early Years Versions

115



Page Link - see page

View more styles...

251



Arrow stool

- H440 x W400 x D600mm

Y420130*	Fabric	£244.50
Y420132*	Vinyl	£261.00



Large island stool

- H840/440 X D1340mm

YSTYISF*	Fabric	£917.00
YSTYISV*	Vinyl	£971.00



Oasis

- Developed as a modular solution with endless configurations, we can furnish spaces to suit layout, size, height and design preferences
- Comfortable modular seating with optional 530mm back extension. See page 240-241 for more options



More from this range
on pages 240-241

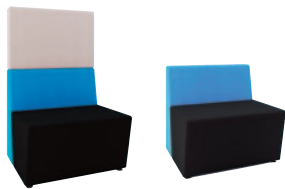

Single seater straight unit

Y600110	1 Seater	£718.00
Y600115	1 Seater with Back Extension	£1002.00

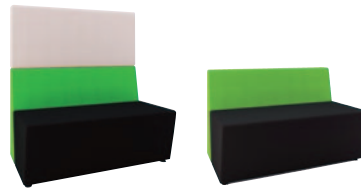

2 seater straight unit

Y600120	2 Seater	£872.00
Y600125	2 Seater with Back Extension	£1184.00

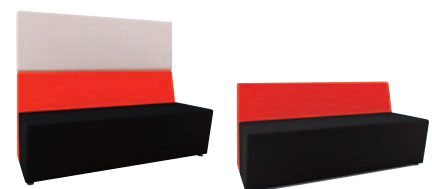

3 seater straight unit

Y600130	3 Seater	£1005.00
Y600135	3 Seater with Back Extension	£1358.00



Corner unit

Y600140	Corner Unit	£711.00
Y600145	Unit with Back Extension	£1051.00

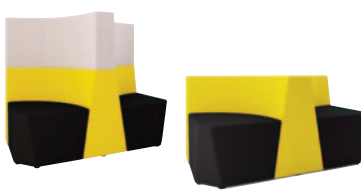

T module unit

Y600150	T Module Unit	£1263.00
Y600155	Unit with Back Extension	£1792.00

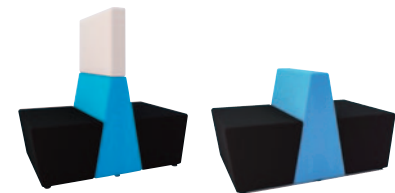

Back to back single seater

Y600160	Back to Back Single Seater	£1006.00
Y600165	Unit with Back Extension	£1325.00

Whisper



- High back seat units, ideal for creating designated areas to enhance privacy and noise reduction
- Freestanding straight, concave and convex options
- Linking brackets can be added as an on-cost

A. YWHIS1	Double Straight High Back Seat Unit	£900.00
B. YWHIS4	Single High Back Seat Unit	£658.00
C. YWHIS2	45 Degree Concave High Back Seat Unit	£1044.00
D. YWHIS3	45 Degree Convex Straight High Back Seat Unit	£907.00

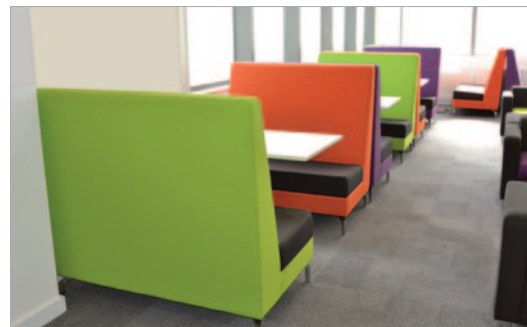

Unlimited fabrics available

Prices shown are for Era and Rivet fabrics only - see pages 288-289. Please contact us for prices on other fabrics.



Comb

- This break out seating range includes a deeply cushioned hexagon shaped seat
- Available in both 350mm and 450mm height
- Seats are available in a wide choice of fabrics

YCOMB350	Comb Soft Seating 350mm
YCOMB450	Comb Soft Seating 450mm



New Product

Bean bags



- Perfect for indoor as well as outdoor use, this versatile bean bag is great for relaxed learning environments
- Tough wipe-clean waterproof fabric makes it perfect for outdoor reading
- Available in a range of bright colours
- Other fabric options available including pastel colours, quilted, fur and suede

		H x W x L(mm)	
Y400900	Mini Relax Pod	740 x 740 x 710	£84.50
Y400901	Mighty Relax Pod	800 x 990 x 940	£135.50
Y400902	Monster Relax Pod	940 x 1160 x 800	£191.00



Made from waterproof material

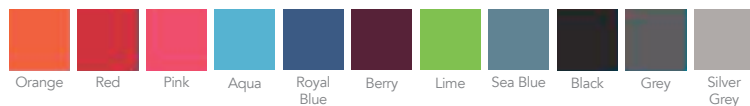



Retreat - Booth



Retreat - Cube



Retreat - Curve

Retreat

Retreat is a range of acoustic work areas created to make open spaces private.

With numerous styles, configurations and a full range of accessories, Retreat can be used in many different environments.

Please contact us for more details and ask about our planning and design services.



Blox

Tiered seating – perfect for library and school environments! The Blox range offers total modularity which means that a room can be quickly and easily converted to whatever use is required, even using the units as room dividers to accommodate separate groups. Its style and functionality are matched by its quality, comfort and durability. The Blox range is available in numerous configurations and is upholstered in a wide range of fabric, vinyl or leather. A plywood base option with a fabric seat pad is also available. Please contact us for more details!



Hive

The Hive range nestles and tessellates to optimise available space, allowing the creation of an agile and flexible work space. Perfect for encouraging self-directed learning amongst students, the Hive pods create a quiet space amongst the bustle ensuring optimum productivity.

Please call for more information



Raft high back

A highly versatile modular seating system, the Raft High Back range combines pleasing aesthetics with acoustic properties to create a practical and affordable learning environment solution.

See pricing and more of the range on page 243

See page 243 for the full Raft high back range

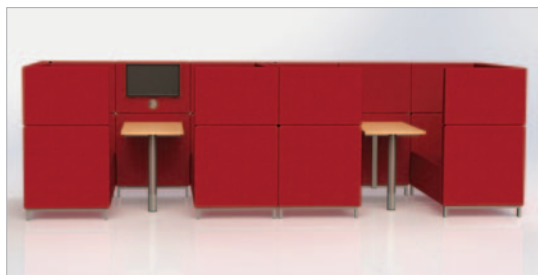



Are you and your visitors sitting comfortably?

Whether it's Office and Reception chairs, Sixth Form and Breakout seating or Conference seating and IT chairs – they're all tried and tested, comfortable and robust.

Seating

Quick Search Guide	222-223
Soft Seating For Libraries, Staffrooms, Receptions, 6th Forms, Breakout	224-251
Coffee Tables	252-253
Operator Seating	254-259
Task Seating	260-263
Executive Seating	264-265
Ergonomic Back Care Seating	266-267
Conference & Cafe Seating	268-281
Executive Conference Seating	282-283
Seating Size Guide	284-287
Fabric Swatches	288-291

Seating

When you buy seating, you are buying comfort.

We understand that work demands long hours of sitting and the chair sat on will make an impact not only on the quality of work delivered and students results, but also on users health.

All our seating ranges are selected for their excellent fit into learning environments, and our soft seating and reception ranges are designed to inspire and invigorate staff, visitors, and students alike.





aspect 224-225



horizon 226



swing 227



motion 227



jade 228



june 228



jupiter 228



jasmin 229



jasper 229



juliette 229



ivy 230



azalea 230



alyssa 231



aster 231



rally 232



imperial 232



cyprus 232



meridian 233



meridian plus 233



amaryllis 233



retro leather 234



retro fabric 234



sorano 234



legend 235



pluto 235



viva 236



java 236



tide 237



consuelo 237



valencia 238



barbary 238



cheltenham 239



chesterfield 239



oasis 240-241



raft 242



raft high back 243



whisper 244



city 244



ravenna 245



chat 246



quiet room 247



aston hut 247



confer 248



convey 249



consort 250



verve 250

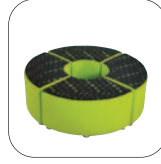

stylo 251



stylo plus 251



causeway 251

wilmington coffee
tables 252

aspect table 252

chrome leg tables
2513

alpine tables 253

nova wood tables
253

e-magic 254



breeze 254



merlin 255



score 256



merlin plus 256



melbourne 257



merlin mesh 257



chime mesh 258



florida 258



waverton 259



breathe 259



cusiro 260



chess 260



westminster 261



strike 262



comfort 262



arrow exec. 263



gorgio 264



racer 264



washington 264



chelsea 265



knightsbridge 265



francisco 265



ergotek 266



redwood 267



rheos 267



mercury 268



westbury 268



define 268



venus deluxe 269



cosmos 269



finley 269



franklin 270



college fleet 270



fleet plus 270



fleet 271



bayonne 272



belgravia 272



neptune 273



track 273



society 274-275



cathedral 276



icon 276



kraft 277



stax 278



roma 278



fusion 279



evergreen 280



narvik 280



molde 280



topaz 281



eames 282



washington 282



charles 282



chelsea 283



racer 283



mayfair 283



Quick search product guide

Reception & Staffroom Seating

Aspect modular reception



- A flexible range of modular seating with wide range of arm choices
- Fully upholstered modular furniture with deep filled cushions for comfort
- Matching table with oak look or glass top



A. Chair - No Arms



B. Chair - Left Arm



C. Chair - Right Arm



D. Armchair



E. 2 Seater Sofa



F. Corner Unit



G. 30° Internal Link



H. 60° External Link



I. Oak Top Table



J. Glass Top Table

Reception & Staffroom Seating



Aspect Modular Reception

A. YREC25W*	Chair - No Arms	£199.00	YREC32RW*	Internal Link With Right Arm	£293.00
B. YREC26W*	Chair - Left Arm	£253.00	YREC33LW*	External Link With Left Arm	£290.00
C. YREC27W*	Chair - Right Arms	£253.00	YREC33RW*	External Link With Right Arm	£290.00
D. YREC28W*	Armchair	£316.00	I. YREC04W*	Oak Top Table	£177.00
E. YREC29W*	2 Seater Sofa with Arms	£554.00	J. YREC04G*	Glass Top Table	£167.00
F. YREC31W*	Corner Unit	£332.00	YTWOT	Extra Charge for 2-Tone Fabrics from Band 1	£31.00
G. YREC32W*	Internal Link	£250.00			
H. YREC33W*	External Link	£249.00			
YREC32LW*	Internal Link With Left Arm	£293.00			

* Please specify fabric colour

For seat dimensions see pages 284-287

Reception & Staffroom Seating

Horizon

- Comfortable angled seat



YHOR01	Horizon Modular Chair	£317.00
YHOR01LA	Horizon Modular Chair w/Left Arm	£441.00
YHOR01RA	Horizon Modular Chair w/Right Arm	£441.00
YHORA	Horizon Modular Armchair	£573.00
YHOR02	Horizon Modular 30 Degree Outer Corner Segment	£299.00
YHOR03	Horizon Modular 30 Degree Inner Corner Segment	£299.00
YHORCBE	Horizon Coffee Table, Beech Top	£283.00
YHORCMA	Horizon Coffee Table, Maple Top	£283.00
YHORCOA	Horizon Coffee Table, Oak Top	£283.00
YHORCFB	Horizon Coffee Table, Fabric Top	£283.00



Unlimited fabrics available

Prices shown are for Era, Phoenix, Rivet & X2 - see pages 288-290.
Please contact us for prices on other fabrics.



Non standard fabric shown - please call for prices

For seat dimensions
see pages 284-287



PROTECTOR
Please phone for prices



YHOR01



YHOR01LA



YHOR01RA



YHORA



YHOR02



YHOR03

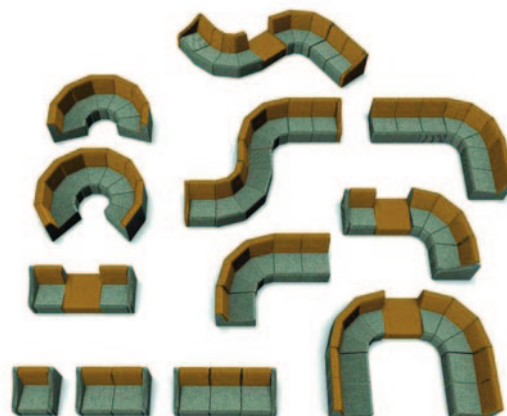

Reception & Staffroom Seating

Swing

- Modern yet cost effective modular chair
- Shapely back available in contrasting fabric to seat (at additional cost)
- Chrome feet
- Modular design for increased flexibility



YSWI1	Modular Chair	£271.00
YSWI1A	Swing Chair with Arms	£368.00
YSWIT	Modular Table with Oak Top	£245.00
YTWOT	Extra Charge for 2-Tone Fabrics from Band 1	£31.00

* Please specify fabric colour



Unlimited fabrics available

Prices shown are for Era, Phoenix, Rivet & X2 - see pages 288-290. Please contact us for prices on other fabrics.



Image shows Aspect coffee table

For seat dimensions see pages 284-287



Non standard fabric shown - please call for prices

Motion

- Distinctly designed modular chair
- Multiple fabrics can be used - ask for prices



YMOT1*	Chair	£302.00
YMOTTS*	Square Table with Oak Top	£199.00
YMOTTG	Motion Square Table with Glass Top	£205.00
YMOTTLA	Chair with Left Arm	£388.00
YMOTTRA	Chair with Right Arm	£388.00
YMOTTA	Armchair	£494.00
YTWOT	Extra Charge for Two Tone Fabrics from Band 1	£31.00

* Please specify fabric colour



Unlimited fabrics available

Prices shown are for Era, Phoenix, Rivet & X2 - see pages 288-290. Please contact us for prices on other fabrics.



5 Year Warranty

Best Seller





Reception & Staffroom Seating

Jade

- Modern office or lounge seat with broad appeal and strong character
- Comfortable and supportive with a sturdy black metal frame
- Curved, contoured backs for enhanced comfort
- Cushions with arm rests designed to fit the curve of the body
- Ideal around a coffee table in a reception or waiting area
- Velvet-style fabric finish available in two finish options

YJA01LG	Light Grey	Single Seater	£500.00
YJA01MB	Mid Blue	Single Seater	£500.00
YJA02LG	Light Grey	2-Seater	£760.00
YJA02MB	Mid Blue	2-Seater	£760.00

June

- Clean lines and minimalist design with black frame suits any setting
- Curved, contoured backs for enhanced comfort
- Ideal around a coffee table in a reception or waiting area
- Modern office or lounge seat with broad appeal and strong character
- Sturdy but lightweight for easy rearranging
- Velvet-style fabric finish available in two finish options

YJOR01DG	Dark Grey	£500.00
YJOR01LB	Light Blue	£500.00

Jupiter

- Curved, contoured backs for enhanced comfort
- Eye-catching, timeless high back design in two finishes
- Head rest, neck support and integral lumbar add to its functionality
- Ideal around a coffee table in a reception or waiting area
- Modern office or lounge seat with broad appeal and strong character
- Rich velvet fabric with complementary black metal frame

YJUP01DB	Dark Blue	£722.00
YJUP01MU	Mustard	£722.00

Reception & Staffroom Seating

Jasmin

- Contemporary lounge chair with comfortable chunky seat
- In style frame
- Available in three fabric colours: - Mustard, Grey & Blue

YJASMU	Mustard	£334.00
YJASBL	Blue	£334.00
YJASGR	Grey	£334.00



Jasper chair

- A statement piece armchair
- Dark Grey contemporary frame
- Available in Blue, Grey or Mustard

YJASPERBL	Jasper Chair Blue	£404.00
YJASPERGR	Jasper Chair Grey	£404.00
YJASPERMU	Jasper Chair Mustard	£404.00



Juliette chair

- Juliette lounge chairs are a perfect way to add more comfort to your office space while adding a stylish accent. A curved shape, lower and wider seating area implies a welcoming invitation to have a seat for anyone passing by
- Lounge chair with horizontal Ribbed back or Plain back
- Available in Black or Chrome Frame
- Ask for Unique Fabric

Black Frame

YJULRBBL	With Ribbed Back	£605.00
YJULPLBL	With Plain Back	£597.00

Chrome Frame

YJULRBCR	With Ribbed Back	£578.00
YJULPLCR	With Plain Back	£597.00



New
Product



For seat dimensions
see pages 284-287

Reception & Staffroom Seating

**A. Ivy chair**

- Designed with comfort in mind, Ivy seating is both eye-catching and timeless, seamlessly crossing the line between classic and contemporary
- Choice of distinctive polished chrome or wooden frame styles
- Luxurious deep-foamed seat
- Curved shell wraps the user in comfort available in a multitude of fabric options
- Upholstered seat and back have a gently contoured shape to maximise comfort

New Product



YIVYPYRAMID Pyramid Oak Legs £552.00

YIVYCHROME4STAR Chrome 4 Star Base £552.00

YIVYCHROMESLEIGH Chrome Sleigh Base £449.00

**B. Azalea chair**

- Lounge furniture with expressive design ideal for spending time reflecting, engaging in creative work or working with colleagues
- Creates a homely feel to your office spaces and a relaxing atmosphere
- Available in Low or High Back
- Wooden or Black Metal Legs
- Two Tone available POA

New Product

Low Back

YAZLBW	Wooden Legs	£1149.00
YAZLBBM	Black Metal legs	£895.00

High Back

YAZHBW	Wooden Legs	£1560.00
YAZHBBM	Black Metal Legs	£1361.00



Reception & Staffroom Seating



A. Alyssa chair

New Product

- Beautifully crafted and elegant design
- Exceptional comfort
- Large choice of fabrics with two-tone options
- Luxurious deep-foamed seat for added comfort
- Smooth, ergonomically-designed lines with comfortable back & arm support
- Traditionally styled, smart, angular soft seating
- Wooden legs & polished aluminium rotating base options

Low Back

YALYLBW	Wooden Legs	£449.00
YALYLB4	4 Star Base	£414.00

High Back

YALYHBW	Wooden Base	£535.00
YALYHB4	4 Star Base	£500.00

B. Aster chair

New Product

- Designed for comfort with sculpted seat and back cushions
- A mix of retro style and contemporary design, crafted with a sturdy construction
- Large choice of fabrics with two-tone options
- Choice of 3 frame styles
- Unique chair with generously proportioned seating position

Low Back

YASTLOWW	Wooden Base	£760.00
YASTLOW4STAR	4 Star Base	£760.00
YASTLOWSPIRAL	Spiral Base	£760.00

High Back

YASTHIGHW	Wooden Base	£898.00
YASTHIGH4STAR	4 Star Base	£898.00
YASTHIGHSPIRAL	Spiral Base	£898.00
YASTCOFFEE	Spiral Base Coffee Table	£232.00

Reception & Staffroom Seating

A. Rally

- Excellent for staffrooms, common rooms & heavy use areas
- Extra heavy duty skid base reception chair
- Extra deep foam padding for extra comfort
- Black frame as standard, silver and grey available to order (price on request)



		1-9	10+
YRALI*	Side Chair	£178.00	POA

* Please specify fabric colour



15 Year
Maker's
Guarantee

Best
Seller



B. Imperial

- Extremely durable range of chairs
- Extra deep foam padding
- Black frame as standard, silver and grey available to order (price on request)



YIMP1*	Side Chair	£158.00
YIMPA*	Armchair	£221.00

* Please specify fabric colour

C. Cyprus

- Robust, rectangular steel frame
- Epoxy polyester frame coating
- Top grade, extra deep contour foam
- Highly polished, solid beech arms
- Complementary Beech laminate table tops
- Optional frame colours available (minimum order quantity of 10)



YCC50*	Chair	£281.00
YCC55*	Armchair	£336.00
YCC255*	2 Seater Armchair	£601.00

YCC20	Square Coffee Table	£255.00
YCC30	Rectangular Coffee Table	£308.00

YCRAL7	Optional Grey Frame (min 10 items)	+£15.00
YCRAL9	Optional Silver Frame (min 10 items)	+£15.00
YCRAPF	Cyprus Optional Platinum Frame	+£17.00

* Please specify fabric colour



Unlimited fabrics available

Prices shown are for Era, Phoenix, Rivet & X2 - see pages 288-290. Please contact us for prices on other fabrics.



For seat dimensions
see pages 284-287

Reception & Staffroom Seating

Meridian

- Low level beech framed seating
- 5 year guarantee
- No assembly required
- Flame retardant foam



5 Year
Warranty

YMER1A	Low Back Chair	£306.00
YMER1AA	Low Back Armchair	£324.00
YMER1RA	Low Back Chair with Right Arm	£310.00
YMER1LA	Low Back Chair with Left Arm	£310.00
YMER2AA	Low Back Two Seater Settee with Arms	£601.00
YMER1M	Medium Back Chair	£334.00
YMER1MA	Medium Back Armchair	£347.00
YMER1MRA	Medium Back Chair with Right Arm	£338.00
YMER1MLA	Medium Back Chair with Left Arm	£338.00
YMER2MA	Medium Back 2 Seater Settee w/Arms	£647.00
YMER1H	High Back Chair	£300.00
YMER1HA	High Back Armchair	£367.00

* Please specify fabric colour



Low Back



High Back



Medium Back

Meridian plus

- Hardwood frames from sustainable sources
- Comfortable shaped back
- Mortice and tenon joints
- Flame retardant foam seats
- Modular design
- Manufactured in the UK
- 5 year guarantee



YMERPL	Meridian Plus Low Back	£389.00
YMERPLA	Meridian Plus Low Back with Arms	£433.00
YMERPH	Meridian Plus High Back	£422.00
YMERPHA	Meridian Plus High Back with Arms	£462.00

* Please specify fabric colour



Amaryllis chair

- A Sophisticated modern design, Ideal for restaurants, meeting rooms & receptions areas
- Available in as a 2 seater, Armchair or Side chair
- Ash Lacquered legs

YAMSC	Amaryllis Side Chair	£377.00
YAMAC	Amaryllis Armchair	£397.00
YAM2S	Amaryllis 2 Seater	£773.00

New
Product



Unlimited fabrics available

Prices shown are for Era, Phoenix, Rivet & X2 - see pages 288-290. Please contact us for prices on other fabrics.

For seat dimensions
see pages 284-287

Best Seller

For seat dimensions
see pages 284-2875 Year
Warranty

Reception & Staffroom Seating

Retro leather tub

- Ideal for head teachers office or reception
- Sturdy and comfortable
- Faced in split leather in Black or Chocolate
- Other colours available to order

YREC10BK	Retro Tub Chair Black	£376.00
YREC10CH	Retro Tub Chair Chocolate	£376.00
YREC102BK	Retro Tub 2 Seater Black	£586.00
YREC102CH	Retro Tub 2 Seater Chocolate	£586.00

Retro fabric tub chairs

- Ideal for reception or Break Out Areas
- Available in Single or Double Seater
- Black Feet Glides
- 5 year warranty
- Made in the UK



Y600100	Single Tub	£376.00
Y600102	Double Tub	£586.00

Sorana tub

- Choice of 3 stylish bases
- Trumpet & square base – height adjustable
- 360 degree swivel
- 5 year warranty



YSTRUMPET	Trumpet Base Height Adjustable	£404.00
YSSQUARE	Square Base Height Adjustable	£463.00
YSSPIDER	Spider Base	£498.00



Unlimited fabrics available

Prices shown are for Era, Phoenix, Rivet & X2 - see pages 288-290.
Please contact us for prices on other fabrics.

Reception & Staffroom Seating

Legend

- Sturdily built chair
- Attractive beech wood or chrome feet
- Deep, fibre-topped seat cushions



Beech Feet

YLEG1B*	Tub Chair	£545.00
YLEG2B*	2 Seater	£809.00

Chrome Feet

YLEG1C*	Tub Chair	£642.00
YLEG2C*	2 Seater	£905.00

* Please specify fabric colour



Unlimited fabrics available

Prices shown are for Era, Phoenix, Rivet & X2 - see pages 288-290. Please contact us for prices on other fabrics.



5 Year
Warranty



Non standard fabric shown
- please call for prices

Pluto

- Compact stylish tub chair
- Modern chrome feet
- 2-tone fabric at no extra cost
- Ideal for areas with limited space
- Seat height 440mm, width 650mm overall
- Combining a generously proportioned seat with a compact overall footprint.
- Three foot styles: - Black Brushed, Polished Chrome & Polished Chrome Ball Foot. Comes as standard with Black Brushed. Please specify if non-standard option is preferred

YPSL1	Chair with Standard Foot Style	£586.00
-------	--------------------------------	---------

* Please specify fabric colour



Unlimited fabrics available

Prices shown are for Era, Phoenix, Rivet & X2 - see pages 288-290. Please contact us for prices on other fabrics.



For seat dimensions
see pages 284-287

Reception & Staffroom Seating

5 Year
Warranty

Viva

- Minimalist elegance and enduring comfort is what makes Viva great. Viva has a stylish look balanced by an elegant silhouette where the soft curves render a feminine and playful touch that will fit into almost any room, lounge, meeting area or leisure environment. Moreover, the Viva tub chair has a compact footprint, which is excellent for space optimisation
- Available in Black frame, Chrome Frame POA, Angled or Curved Frame

A. YVIV01	Viva Tub Chair with 4 Angled Black Legs	£433.00
B. YVIV02	Viva Tub Chair with 4 Curved Black Legs	£433.00



Unlimited fabrics available

Prices shown are for Era, Phoenix, Rivet & X2 - see pages 288-290.
Please contact us for prices on other fabrics.

For seat dimensions
see pages 284-287



Java

- Beautifully simple
- Modular design means that Java looks good as a single bench or as a large configuration to dramatically fill an atrium
- Black frames as standard, Chrome legs POA

A. YJAVA01	1200 Bench Unit	£593.00
B. YJAVAST	Square Connecting Table	£380.00
C. YJAVA	Table	£482.00
YJAVLNK	Linking Device	£10.00



Unlimited fabrics available

Prices shown are for Era, Phoenix, Rivet & X2 - see pages 288-290.
Please contact us for prices on other fabrics.

A



B



C



Reception & Staffroom Seating

Tide

- Modern visitor and reception chair
- Generously sized bucket seat



YTGIG2*	Chair with Skid Base	£613.00
YTGIG4	Chair with Cross Over Skid Base	£613.00
YTGIG5	Coffee Table	£429.00

* Please specify fabric colour



Unlimited fabrics available

Prices shown are for Era, Phoenix, Rivet & X2 - see pages 288-290. Please contact us for prices on other fabrics.



5 Year
Warranty

For seat dimensions
see pages 284-287

Consuelo

- Stylish visitor chair
- 4 base styles with platinum finish



A. YCON2	Visitor Seat with Spider Base	£523.00
B. YCON3	Visitor Seat with 4 Leg Base	£469.00
C. YCON4	Visitor Seat with Skid Base	£469.00
D. YCON5	Visitor seat w/ black 4 Legged Frame	£587.00

* Please specify fabric colour



Unlimited fabrics available

Prices shown are for Era, Phoenix, Rivet & X2 - see pages 288-290. Please contact us for prices on other fabrics.



Reception & Staffroom Seating



Cushion pictured in non standard fabric - please call for prices

Valencia

- Designed with striking square lines, deep fill cushions and a choice of legs
- Comes with Chrome legs as standard, Beech and Walnut also available, please ask
- UK made



YVAL01	Valencia Armchair	each	£900.00
YVAL02	Valencia 2 Seat Sofa	each	£1508.00
YVAL03	Valencia 3 Seat Sofa	each	£1959.00
YVALC	Square Cushion, 400 x 400mm	each	£41.00



Unlimited fabrics available

Prices shown are for Era, Phoenix, Rivet & X2 - see pages 288-290. Please contact us for prices on other fabrics.



New
Product



Barbary

- Available in 1, 2 and 3 seater combinations and with the option of two-tone fabric, the Barbary range is perfect for any breakout or reception area which needs that elusive touch of style. With its modern look and sleek lines, this range offers superb comfort, quality and it absolutely oozes style

YBARB1	Barbary Single seater Armchair	£678.00
YBARB2	Barbary 2 Seater Sofa	£954.00
YBARB3	Barbary 3 Seater Sofa	£1128.00

For seat dimensions
see pages 284-287

Reception & Staffroom Seating

Cheltenham

- Brilliant cost effective sofa range
- Modern aesthetic design & robust build
- Ideal for reception areas and common rooms
- Attractive Chrome feet
- Seat width 830mm, depth 730mm



5 Year
Warranty



Fabric

YSA001F*	Armchair Fabric	£561.00
YSA002F*	2 Seater Fabric	£747.00
YSA003F*	3 Seater Fabric	£905.00

Leather

YSA001L*	Armchair Leather	£787.00
YSA002L*	2 Seater Leather	£969.00
YSA003L*	3 Seater Leather	£1175.00

* Please specify fabric colour



Unlimited fabrics available

Prices shown are for Era, Phoenix, Rivet & X2 - see pages 288-290.
Please contact us for prices on other fabrics.



Chesterfield sofa

- Made with Traditional Antique Leather
- UK Manufactured
- Available in single, double or triple seater
- Ask for Leather Swatch

YCHESERFIELDS	Single Seater
YCHESTERFIELDDD	Double Seater
YCHESTERFIELDT	Triple Seater



Unlimited fabrics available

Prices shown are for Era, Phoenix, Rivet & X2 - see pages 288-290. Please contact us for prices on other fabrics.



For seat dimensions
see pages 284-287

Reception & Staffroom Seating



Please note that back extensions cannot be retrospectively fitted

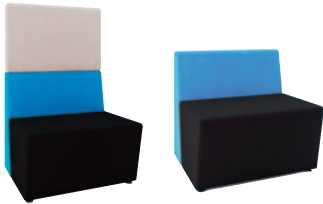

Single seater straight unit

Y600110	Single Seater	£718.00
Y600115	Single Seater High Back	£1002.00

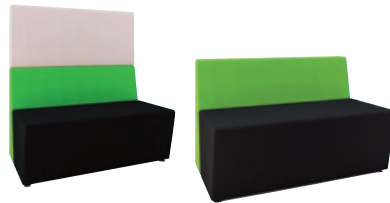

2 seater straight unit

Y600120	2 Seater	£872.00
Y600125	2 Seater High Back	£1184.00



3 seater straight unit

Y600130	3 Seater	£1005.00
Y600135	3 Seater High Back	£1358.00



Corner unit

Y600140	Corner Unit	£711.00
Y600145	Corner Unit High Back	£1051.00

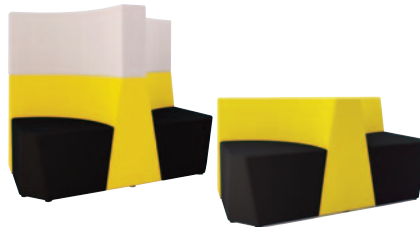

T module unit

Y600150	T Module Unit	£1263.00
Y600155	T Module Unit High Back	£1792.00

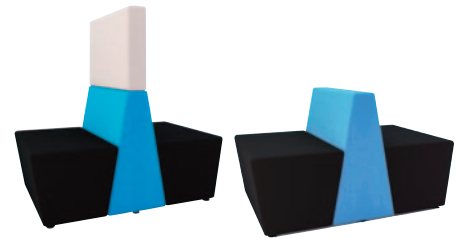

Back to back single seater

Y600160	Back to Back Single Seater	£1006.00
Y600165	High Back	£1325.00

Reception & Staffroom Seating

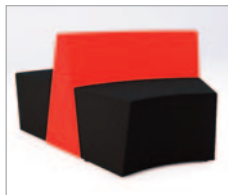
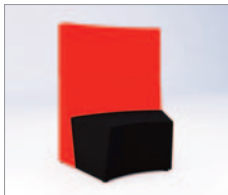

Oasis

- Developed as a modular solution with endless configurations, we can furnish spaces to suit layout, size, height and design preferences. Oasis seeks to empower people to come together whether it be for working practices or purely to meet, socialise and communicate individually or as groups
- Comfortable modular seating with optional 530mm back extension



Unlimited fabrics available

Prices shown are for Era, Phoenix, Rivet & X2 - see pages 288-290. Please contact us for prices on other fabrics.

Please note that back extensions cannot be retrospectively fitted

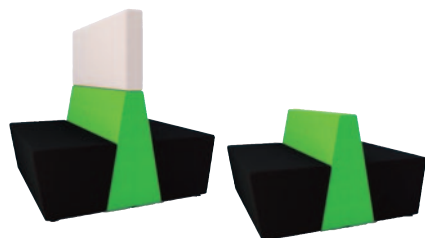

Back to back double seater

Y600170	Back to Back Double Seater	£1230.00
Y600175	Back to Back Double High Back	£1517.00

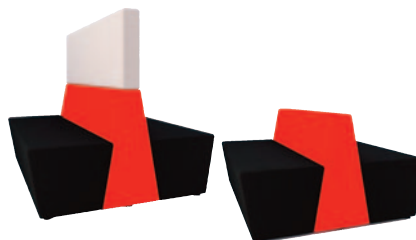

Back to back triple seater

Y600180	Back to Back Triple Seater	£1472.00
Y600185	Back to Back Triple High Back	£1876.00

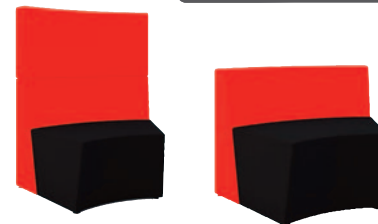

45 degree concave

Y600190	45 Degree Concave Unit	£898.00
Y600195	45 Degree High Back	£1302.00

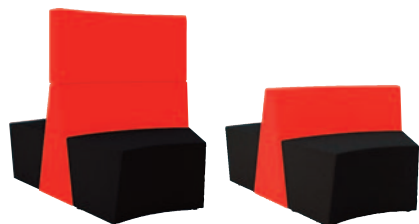

45 degree back to back curved unit

Y600200	Back to Back Curved Unit	£1386.00
Y600205	Back to Back Curved High Back	£1778.00



D end unit

Y600210	D End Unit	£594.00
---------	------------	---------



45 Degree convex unit

Y600220	45 Degree Convex Unit	£855.00
Y600225	45 Degree High Back	£1234.00

Reception & Staffroom Seating



Raft

- Highly versatile modular seating system
- Many configurations can be created
- Black frame as standard
- Sprung seat
- Optional extras available – floating leg, castors, writing table, skid frame
- Optional non-standard colour to legs available

A.	YRAF1	Single Base Unit	£306.00
B.	YRAF1B	Single Base Unit w/Back	£421.00
C.	YRAF1BR	Single Unit w/Back & Right Arm	£568.00
D.	YRAF1BL	Single Unit w/Back & Left Arm	£568.00
E.	YRAF1BA	Single Unit w/Back & Two Arms	£716.00
F.	YRAF1CB	Single Unit w/Corner Back	£628.00
G.	YRAF2	Double Base Unit	£494.00
H.	YRAF2B	Double Unit w/Back	£665.00
I.	YRAF2BR	Double Unit w/Back & Right Arm	£812.00
J.	YRAF2BL	Double Unit w/Back & Left Arm	£812.00
K.	YRAF2BA	Double Unit w/Back & Two Arms	£959.00
L.	YRAF3	Quadrant Base Unit	£391.00
M.	YRAFT	Table with Beech Top	£349.00
N.	YRAF3B	Triple Unit w/Back	£1066.00
O.	YRAF3BA	Triple Unit w/Back & 2 Arms	£1350.00
P.	YRAFN15	Laptop Coffee Table	£286.00



Unlimited fabrics available

Prices shown are for Era, Phoenix, Rivet & X2 - see pages 288-290.
Please contact us for prices on other fabrics.

A

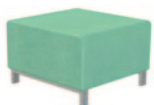

B



C



D



E



F



G

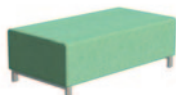

H

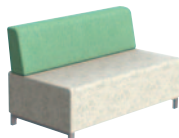

I



J



K



L



N

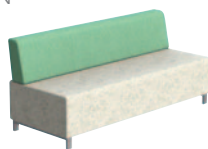

O



P



Reception & Staffroom Seating

Raft high back

- Highly versatile modular seating system
- Many configurations can be created
- Black frame as standard
- Sprung seat
- Optional extras available – floating leg, castors, writing table, skid frame



A. YRAFH1	Single Unit, High Back	£737.00
B. YRAFH1R	Single Unit, High Back & Right Side	£1078.00
C. YRAFH1L	Single Unit, High Back & Left Side	£1078.00
D. YRAFH1S	Single Unit, High Back & Sides	£1419.00
E. YRAFH2	Double Unit, High Back	£1130.00
F. YRAFH2R	Double Unit, High Back & Right Side	£1470.00
G. YRAFH2L	Double Unit, High Back & Left Side	£1470.00
H. YRAFH2S	Double Unit, High Back & Sides	£1810.00
I. YRAFHCV	Concave Unit, High Back	£1317.00
J. YRAFHCX	Convex Unit, High Back	£1231.00
K. YRAFHC	High Back Unit, Corner Back	£1091.00
L. YRAFHV	Vertical Unit (includes Links)	£842.00
M. YRAFHVT	Vertical Unit, Single Width Table	£824.00
N. YRAFHDT	Vertical Unit, Double Width Table	£884.00

Options

O. YRAFCL	Option - Chrome Legs	+£74.00
P. YRAFLNK	Option - Linking kit (one side)	+£34.00
Q. YRAFPM1	Option - Power Module 1, Power & Twin USB Fast Charge	+£328.00
R. YRAFPM2	Option - Power Module 2, HDMI & Single USB Fast Charge	+£457.00



Unlimited fabrics available

Prices shown are for Era, Phoenix, Rivet & X2 - see pages 288-290. Please contact us for prices on other fabrics.

For seat dimensions see pages 284-287

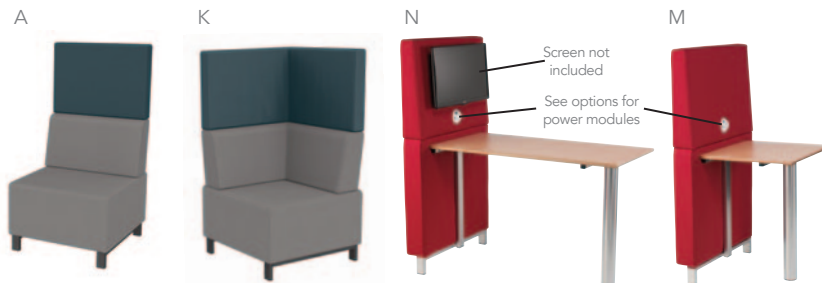

Non standard fabric shown - please call for prices



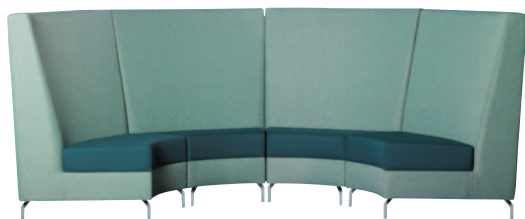
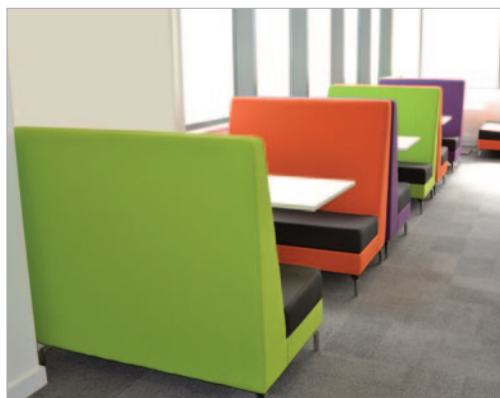

Reception & Staffroom Seating

Whisper



- High back seat units
- Be inspired and create your own seating configuration with this modular system
- Ideal for creating designated areas to enhance privacy and noise reduction.
- A straight, concave and convex option, all units are freestanding
- Linking brackets can be added as an on-cost

A. YWHIS1	Double Straight High Back Seat Unit	£900.00
B. YWHIS4	Single High Back Seat Unit	£658.00
C. YWHIS2	45 Degree Concave High Back Seat Unit	£1044.00
D. YWHIS3	45 Degree Convex Straight High Back Seat Unit	£907.00

A



B



C



D



Unlimited fabrics available

Prices shown are for Era, Phoenix, Rivet & X2 - see pages 288-290. Please contact us for prices on other fabrics.

A



B



C



D



E



F



G



H



I



J



City sofas



- Versatile modular seating system
- Deep seat foam
- Heavy duty steel under frame
- Welded steel linking option meaning that units can be fixed together

A. YCITB1	City Single Seat With Back	£395.00
B. YCITDB1	City Double Seat With Back	£609.00
C. YCITTB1	City Three Seat With Back	£754.00
D. YCIT1	City Single Seat Without Back	£323.00
E. YCIT2	City Double Seat Without Back	£484.00
F. YCIT3	City Three Seat Without Back	£671.00
G. YCIT4	90 Deg External Corner Seat w/ Back	£568.00
H. YCITC1	90 Deg Internal Corner Seat w/ Back	£620.00
I. YCITCON1	City Corner Seat Without Back	£425.00
J. YCITTAB2	City 4 Way Seat	£535.00

Optional Extras

YCITLKL	Extra Cost For Link - Left Hand as Seated	+£34.00
YCITLKR	Extra Cost for link - Right Hand as Seated	+£34.00



Unlimited fabrics available

Prices shown are for Era, Phoenix, Rivet & X2 - see pages 288-290. Please contact us for prices on other fabrics.

Reception & Staffroom Seating

Ravenna

- This premium sofa range is available in single, two seat and three seat configurations, with a choice of LH and RH arm options to allow you to get creative
- The Ravenna sofa range will elevate any workspace, meeting, breakout, or waiting room interior
- Black skid base frame supplied as standard
- Optional Beech frame - POA

YRLB1	Single Seater	£475.00
YRLB10	Single Seater w/ Back	£772.00
YRLB12A	Armchair w/ Back Panel	£1127.00
YRLB15A	Armchair w/ Shallow Privacy Panels	£1689.00
YRLB15AL	LH Single Seat w/ Shallow Privacy Panel	£1231.00
YRLB15AR	RH Single Seat w/ Shallow Privacy Panel	£1231.00
YRLB1A	Single Seater Armchair	£831.00
YRLB1AL	Single Seater w/ Left Arm	£652.00
YRLB1AR	Single Seater w/ Right Arm	£652.00
YRLB2	2 Seater	£737.00
YRLB20	2 Seater w/ Back	£1283.00
YRLB22A	2 Seater w/ Back Panel	£1640.00
YRLB25A	2 Seat w/ Back Panel & Shallow Panels	£2201.00
YRLB25AL	2 Seat w/ L/Hand Shallow Privacy Panel	£1742.00
YRLB25AR	2 Seat w/ R/ Hand Shallow Privacy Panel	£1742.00
YRLB2A	2 Seater w/ Arms	£1092.00
YRLB2AL	2 Seater w/ Left Arm	£915.00
YRLB2AR	2 Seater w/ Right Arm	£915.00
YRLB3	3 Seater	£1143.00
YRLB30	3 Seater w/ Back	£1917.00
YRLB32A	3 Seater Armchair w/ Back Panels	£2273.00
YRLB35A	3 Seat Armchair w/ Shallow Privacy Panels	£2834.00
YRLB35AL	3 Seat w/back LH Arm & Shallow Arm	£2375.00
YRLB35AR	3 Seat w/back RH Arm & Shallow Arm	£2375.00
YRLB3A	3 Seater Armchair	£1499.00
YRLB3AL	3 Seater w/ LH Arm	£1321.00
YRLB3AR	3 Seater w/ RH Arm	£1321.00



Image shows shallow privacy panels



Unlimited fabrics available

Prices shown are for Era, Phoenix, Rivet & X2 - see pages 288-290.
Please contact us for prices on other fabrics.



Bracket



90° Bracket



Beech Frame
Optional extra - POA



Reception & Staffroom Seating



Chat

- Chat Makes a statement
- The collaborative dens are great for seating up to 7 people
- Available in 3 Heights, Low, Mid or High Back

YCHATLD	Low Den
YCHATMDB	Mid Back Den
YCHATHBD	High Back Den
YCHATCT	Circular Table 1000mm Dia. White

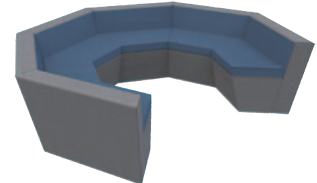
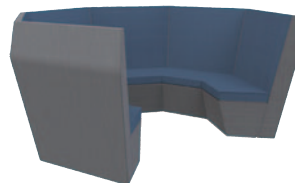

Reception & Staffroom Seating

Quiet room

- QUIET ROOM is the oasis of silence in a middle of a modern office. Thanks to this office solution, concentrating at work has never been easier as it enables employees to focus during phone conversations, video conferences or creative tasks without distracting others. QUIET ROOM ensures indoor air quality as well as acoustic and visual comfort for employees
- Comes as standard with lighting & ventilation
- Available in Single person, 2 person or 4 person

YQRS Single Person Quiet Room

YQRD 2 Person Quiet Room

YQRQ 4 Person Quiet Room



Aston hut

- For a greater degree of privacy, the Aston Hut provides the answer. The Aston Hut features a high acoustic surround, with the addition of a complete upholstered roof create a fully upholstered seating solution for 4 or 6 persons
- Wherever you situate the Aston Hut, it will exude understated, restful confidence and create a genuine talking point

Options available: -

- Single or 2-tone fabrics
- Upholstered arm cushions
- Upholstered Rectangular loose cushions
- Upholstered Square loose cushions
- MFC Vase shaped table
- Power module – 2 x power
- Power module – 2 x power, 2 x USB
- Power module – 1 x power, 2 x USB, 1 x HDMI

Y609800 Aston 4 Seater Hut

Y609801 Aston 6 Seater Hut





Unlimited fabric options
available, please enquire

Confer

- Confer is a range that is needed in most open space environments in today's interior space planning
- Whether you are making a phonecall, having a one 2 one meeting, group meetings, private chats or just sitting in an area that is comfortable and pleasing to the eye the confer range provides it all, while reducing the noise level
- Includes standard MFC panels & desktop on pedestal base
- Power, lighting and TXV rackets also available – please enquire

Flat Roof

Y620100	1 Seater Booth
Y620105	2 Seater Booth
Y620110	4 Seater Booth

Pitched Roof

Y620115	2 Seater
Y620120	4 Seater



Convey

- Featuring a dynamic, fresh design Convey is the perfect range for the modern learning and workplace environment
- The modular sofa range is available with a high back, all with its unique 'U' shaped arm creating great flexibility
- If you want to create a little privacy Convey is also available with or without a roof option, with the option for power and USB ports, making it perfect for breakout, workspace, meeting and presentation areas

Convey with Roof

Y620200 2 Seater Convey Booth with Roof

Y620205 4 Seater Convey Booth with Roof

Y620210 6 Seater Convey Booth with Roof

Convey Open Top

Y620220 2 Seater Convey Booth - Open Top

Y620225 4 Seater Convey Booth - Open Top



Open Top 2 Seater

Unlimited fabric options
available, please enquire



6 Seater

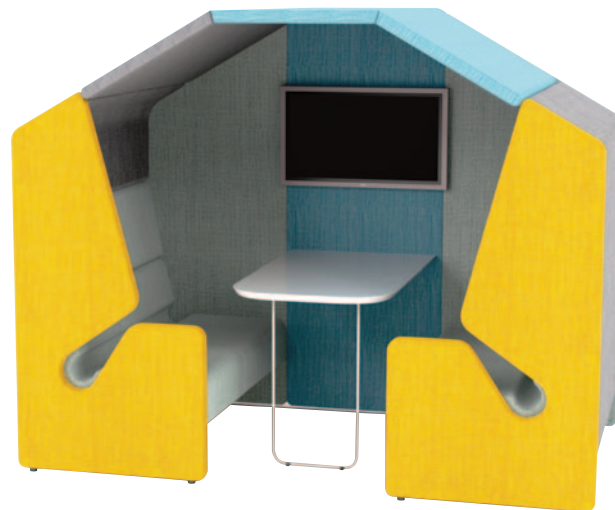

4 Seater



Reception & Staffroom Seating

Consort

- This range enables you to create the space that meets your individual requirements through an easy to use modular system
- Whether it is a circular booth, a presentation space, a breakout area, a sweeping S-shaped seating plan or a combination of all of these then Consort gives you it all
- With a comfortable wire bench seat and optional padded back Consort can be used with poseur height tables, or additional seating to the rear to maximise the available space
- Available in both curved and angular units, with the option of power and USB ports
- Choice of colours for top and back. Stools not included

Y620300	Angular Unit with Poseur Table
---------	--------------------------------

Y620305	Curved Unit with Poseur Table
---------	-------------------------------

Unlimited fabric options
available, please enquire



Verve

The opportunities are endless with the Verve range - simply intertwine pieces to create a unique, creative library or learning area. Verve units are chunky, very comfortable and available in H250, H450 or H650mm. Prices shown are for H450mm. Other configurations available, please just ask!

Y400120	Verve One Seater
---------	------------------

Y400122	Verve Two Seater
---------	------------------

Y400124	Verve Three Seater
---------	--------------------

Y400126	Verve Five Seater
---------	-------------------

Y400128	Verve Join Three Seater
---------	-------------------------

Y400130	Verve Join Four Seater
---------	------------------------

Y400132	Verve Join Five Seater
---------	------------------------

Y400134	Verve Join Six Seater
---------	-----------------------

Y400136	Verve Join Three Seater Pod
---------	-----------------------------



Y400120



Y400122



Y400124

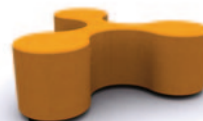

Y400136



Y400132

Stylo & Stylo Plus



- Singularly or in groups, this versatile range of soft seating with endless configurations, makes for an interesting seating solution, whether for reception or breakout areas
- Adult and junior sizes
- Stylish, multi functional design
- No assembly required
- Flame retardant foam

Stylo

YLU21	Circular Seat	£160.00
YLU22	Dogbone Seat	£197.00
YLU23	Kidney Shaped Seat	£197.00
YLU24	Square Seat	£173.00
YLU25	Apostrophe Seat	£235.00
YLU26	Double Seater	£194.00
YLU28	Quadrant	£208.00



5 Year
Warranty

Stylo plus

Like the Stylo but with chrome feet and adult sizes

- Eight stylish designs

YLP21	Circular Seat	£228.00
YLP22	Dogbone Seat	£262.00
YLP23	Kidney Shaped Seat	£254.00
YLP24	Square Seat	£250.00
YLP25	Apostrophe Seat	£310.00
YLP26	Double Seater	£264.00
YLP27	Circular Nibble	£228.00



For seat dimensions
see pages 284-287



Unlimited fabrics available

Prices shown are for Era, Phoenix, Rivet & X2 - see pages 288-290.
Please contact us for prices on other fabrics.

Causeway

- These irregular hexagonal form seats are available in two heights that serve as both sitting and backrest units
- Can be freely combined in infinite arrangements
- Ideal for chillout zones, waiting areas and entrance halls
- Connected with black, powder coated metal links

YCWAYHU	High Unit (750mm)	£355.00
YCWAYLU	Low Unit (450mm)	£274.00



New
ProductNew
Product

Non standard
fabric shown -
please call for
prices

Coffee Tables

Wilmington Hairpin Leg Coffee Tables

- Black industrial Style Legs
- Available in Circular, Curved Square, Square or Rectangular shapes
- Wood colours to match Wilmington range
- 410mm High

Circular

YHPCT600	600mm Diameter	£260.00
YHPCT700	700mm Diameter	£276.00

Curved Square

YHPCST66	600 x 600mm	£260.00
YHPCST77	700 x 700mm	£276.00

Square

YHPCT66	600 x 600mm	£222.00
YHPCT77	700 x 700mm	£237.00

Rectangular

YHPCT86	800 x 600mm	£246.00
YHPCT95	900 x 500mm	£246.00

Wilmington Tubular Leg Coffee Tables

- Tubular legs in silver as standard – other leg colours POA
- Available in Circular, Curved Square, Square or Rectangular
- Wood colours to match Wilmington range
- 410mm high

Circular

YTGCT600	600mm Diameter	£260.00
YTGCT700	700mm Diameter	£276.00

Curved Square

YTGCSCT66	600 x 600mm	£260.00
YTGCSCT77	700 x 700mm	£276.00

Square

YTGCT66	600 x 600mm	£222.00
YTGCT77	700 x 700mm	£273.00

Rectangular

YTGCT86	800 x 600mm	£246.00
YTGCT95	900 x 500mm	£246.00

Aspect coffee table

- Matches the aspect range of modular seating on page 224
- Table with Oak look top

YREC04W*	£177.00
----------	---------

Coffee Tables

Column leg coffee tables

- Premium laminate top in a choice of colours - please specify when ordering
- Height 505mm
- 2mm ABS edge

A. YTRUCC	Circular 600mm Diameter	£293.00
B. Y600390	Square 600 x 600mm	£224.00
C. Y600400	Rectangular 1000 x 600mm	£170.00

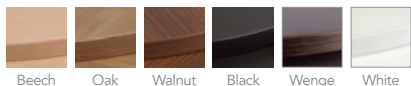

Beech

Oak

Walnut

Black

Wenge

White



A



B

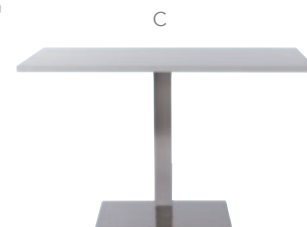

C



Alpine coffee tables

- Matches with office furniture on pages 308 to 309

Panel Base, MFC Tables H400mm

D. YZZN603	Square Table, H600 x D600	£136.00
E. YZZN100	Rectangular Table, W1000 x D600	£204.00
F. YZZN651	Round Coffee Table, Ø650	£146.00

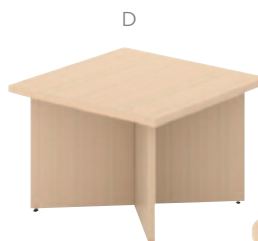

D

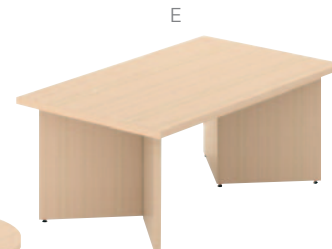

E



F

Nova Wood Coffee Tables

- Nova wood coffee tables with stylish wooden frames
- Available in circular or square
- White tops as standard – wood colour options POA

YCNN070	Circular 700mm Diameter	£267.00
YCNN071	Square Table 700mm Sqaure	£315.00



Express
Delivery

Operator Seating

E-Magic

- Twin lever mechanism
- Back height and angle adjustment
- Styles may vary
- Supplied flat pack for self assembly
- Fixed arms available at additional cost



		1-9	10+
YEMAG01B	Operator Chair	£96.00	POA
YEMAGA	Fixed Arms	+£28.00	+POA

Fabric Options

Charcoal Royal
BlueFor seat dimensions
see pages 284-287Best
Seller5 Year
Warranty

Breeze

- Luxury operator chair
- Advanced lumbar support - for extra back support
- Large back chair has pump up lumbar support
- 3 lever mechanism allows extra adjustment
- Heavy duty gas lift allows heavier use
- Deep padded foam seat for added comfort
- Larger back



A. YBRELB*	Large Back Pump up Lumbar	£200.00
B. YBRELBA*	Large Back with Fixed Arms	£228.00
C. YBRELAAJ*	Large Back with Adjustable Arms	£244.00
YTWOT	Extra Charge for 2-Tone Fabrics from Band 1	£31.00

*Please specify fabric colour



Unlimited fabrics available

Prices shown are for Era, Phoenix, Rivet & Advantage – see pages 288-290. Please contact us for prices on other fabrics



Operator Seating

Merlin

- Low price, high quality
- High back and medium back
- 5 year guarantee



A. Y20106*	Mid Back	£140.00
B. Y20111*	Mid Back - Fixed Arms	£167.00
C. Y20113*	Mid Back - Adjustable Arms	£185.00
D. Y20108*	High Back	£157.00
Y20110*	High Back - Fixed Arms	£171.00
Y20112*	High Back - Adjustable Arms	£188.00
G. Y20301*	High Back Draughtsman Chair	£179.00
H. Y20201*	H/Back Cantilever Conference Chair	£214.00
I. YCH	Chrome Base	+£47.00
J. YCFA	Chrome Fixed Arm	+£34.00
K. YFOLD	Folding Arms	+£52.00
YPULS	Pump up Lumbar Support	+£22.00
YTLM	Three Lever Mechanism (seat tilt)	+£16.00
YTWOT	Extra Charge for 2-Tone Fabrics from Band 1	£31.00

* Please specify colour fabric



Unlimited fabrics available

Prices shown are for Era, Phoenix, Rivet & Advantage – see pages 288-290. Please contact us for prices on other fabrics



High Back



Mid Back



Non standard fabric shown - please call for prices

Some chair options are not shown in the price list - please call for details

For seat dimensions see pages 284-287

5 Year
Warranty

Operator Seating

Score

- Ergonomic operator chair
- Sculptured seat and back for greater comfort
- 2 lever mechanism
- Hand wheel back height adjustment



YGLSHB	High Back Operator Chair	£204.00
YGLSHMA	High Back Operator Chair with Fixed Arms	£224.00
YGLSHAT	High Back Operator Chair with Adjustable Arms	£256.00

* Please specify colour fabric



Unlimited fabrics available

Prices shown are for Era, Phoenix, Rivet & Advantage – see pages 288-290. Please contact us for prices on other fabrics

For seat dimensions
see pages 284-2875 Year
Warranty

Merlin plus

- Modern, comfortable square back
- Twin lever mechanism
- Adjustable back height



A. YMPS66	Merlin Plus High Back	£160.00
B. YMPS66FA	Merlin Plus - Fixed Arms	£188.00
C. YMPS66ADJ	Merlin Plus - Adjustable Arms	£205.00
YTWOT	Extra Charge for 2-Tone Fabrics from Band 1	£31.00



Unlimited fabrics available

Prices shown are for Era, Phoenix, Rivet & Advantage – see pages 288-290. Please contact us for prices on other fabrics

Other options - please call for details



Operator Seating

Melbourne

- Round back operator chair
- Twin lever mechanism
- 5 year guarantee
- Matching visitor chair



YMELR	Operator Chair	£139.00
YMELRA	Chair with Fixed Arms	£162.00
YMELRZA	Chair with Adjustable Arms	£177.00
YMELRFA	Chair with Folding Arms	£194.00
YCH	Chrome Base	+£47.00
YMELBK	Meeting Chair - Black Frame	£180.00
YMELC	Meeting Chair - Chrome Frame	£205.00



Unlimited fabrics available

Prices shown are for Era, Phoenix, Rivet & Advantage – see pages 288-290. Please contact us for prices on other fabrics

For seat dimensions
see pages 284-287



YMELR



Chrome Base
Option



YMELRZA



YMELRBK

Merlin mesh

- Low price, high quality
- High back
- 2 lever mechanism
- 5 year guarantee



YMMHM	Mesh Chair	£140.00
YMMHMA	Mesh Chair with Fixed Arms	£164.00
YMMHMZA	Mesh Chair with Adjustable Arms	£179.00
YCH	Chrome Base	+£47.00
YFOLD	Folding Arms	+£52.00
YTLM	Three Lever Mechanism (seat tilt)	+£16.00



Unlimited fabrics available

Prices shown are for Era, Phoenix, Rivet & Advantage – see pages 288-290. Please contact us for prices on other fabrics



YMMHM



Folding Arms
Option



YMMHMZA

Page Link - see pages

For
fabric
swatches

288-291



Operator Seating

Chime mesh



A. YCHI1B	Operator Chair	£155.00
B. YCHI1BFX	Operator Chair, Fixed Arms	£176.00
C. YCHI1BAD	Operator Chair, Adjustable Arms	£191.00
D. YCHI1BFA	Operator Chair, Folding Arms	£206.00
E. YCHI1C	Operator Chair, Chrome Base	£178.00
F. YCHI1CAD	Operator Chair, Chrome Base, Adjustable Arms	£200.00
G. YCHI1CFA	Operator Chair, Chrome Base, Folding Arms	£228.00
H. YCHI2B	Draughtsman Chair	£183.00
I. YCHI2BAD	Draughtsman Chair, Adjustable Arms	£219.00
J. YCHI2BFA	Draughtsman Chair, Folding Arms	£233.00

* Please specify fabric colour



Unlimited fabrics available

Prices shown are for Era, Phoenix, Rivet & Advantage – see pages 288-290. Please contact us for prices on other fabrics

For seat dimensions
see pages 284-287

High chair with footrail for use at
high workspaces

Florida mesh chair

- Ratchet back
- Three lever mechanism – Dual control
- Mechanism weight tension control
- Seat slide
- Flame retardant foams
- Class 4 gas stem up to 25 stone/150 kilos
- 5 year guarantee (8 hour use)

Y600300	Florida Chair	£217.00
Y600301	Florida Chair w/fixed arms	£238.00
Y600302	Florida Chair w/adjustable arms	£265.00
Y600303	Florida Chair w/folding adjustable arm	£265.00



Unlimited fabrics available

Prices shown are for Era, Phoenix, Rivet & Advantage – see pages 288-290. Please contact us for prices on other fabrics



Operator Seating

Waverton mesh back chair

- Breathable mesh
- Adjustable lumbar support
- Multi-locking synchronous mechanism
- Seat slide adjustment
- Height adjustable arm rests

YWAVEMADJ

£359.00

For seat dimensions
see pages 284-287



Breathe chair

Made to suit even the pickiest sitter, this is a task chair that has been designed with long-term comfort in mind. The precisely tensioned back mesh will keep you cool and dry all day long, while the inbuilt lumbar support and Operator Synchro mechanism will ensure each member of your team can set up their chair precisely to suit them. It's a one-size-fits-all office chair that follows best practice for long-term healthy sitting.

- Cool, flexible mesh back
- Push button mechanism control
- Body Balance mechanism for 'dynamic sitting'
- Height adjustable lumbar pad



YBV32	Chair w/height adjustable lumbar pad	£295.00
YBV32ADJ	Chair w/Adjustable Arms	£340.00
YBVC30	Meeting Chair w/adjustable Lumbar pad	£242.00
YBVEX30	Meeting Chair w/Lumbar pad & Arms	£317.00
YBV40	4 legged Meeting Chair	£280.00
YBV40A	4 Legged Meeting Chair w/Arms	£318.00
YBV50	Cantilever Chair	£253.00
YBV50A	Cantilever Chair w/Arms	£292.00



Unlimited fabrics available

Prices shown are for Era, Phoenix, Rivet & Advantage – see pages 288-290. Please contact us for prices on other fabrics



Best Seller

5 Year Warranty

Express Delivery



Non standard fabric shown - please call for prices



5 Year Warranty



Non standard fabric shown - please call for prices

Task Seating

Cusiro task chair

- Ergonomic, permanent contact back with weight control



A. YTRA11	Black Components	£239.00
B. YTRA11FA	Black Components & Fixed Arms	£263.00
C. YTRA11A	Black Components & Adj Arms	£290.00
D. YTRA12	Chrome Components	£256.00
E. YTRA12FA	Chrome Components & Fixed Arms	£286.00
F. YTRA12A	Chrome & Adjustable Arms	£320.00
YTWOT	Extra Charge for 2-Tone Fabrics from Band 1	£31.00

* Please specify fabric colour



Unlimited fabrics available

Prices shown are for Era, Phoenix, Rivet & Advantage – see pages 288-290. Please contact us for prices on other fabrics

For seat dimensions see pages 284-287

Chess



A. YCHE01	Task Chair with No Arms	£259.00
B. YCHE01F	Task Chair with Fixed Arms	£284.00
C. YCHE01AA	Task Chair with Adjustable Arms	£316.00
D. YCHE01D	Task Chair with Folding Arms	£316.00
E. YCHE02	Task Chair with Chrome Base and No Arms	£286.00
F. YCHE02F	Task Chair with Chrome Base and Fixed Arms	£309.00
G. YCHE01A	Task Chair with Chrome Base and Adjustable Arms	£344.00
H. YCHC01D	Task Chair with Chrome Base and Folding Arms	£343.00
YTWOT	Extra Charge for 2-Tone Fabrics from Band 1	£31.00

* Please specify fabric colour



Unlimited fabrics available

Prices shown are for Era, Phoenix, Rivet & Advantage – see pages 288-290. Please contact us for prices on other fabrics

Task Seating

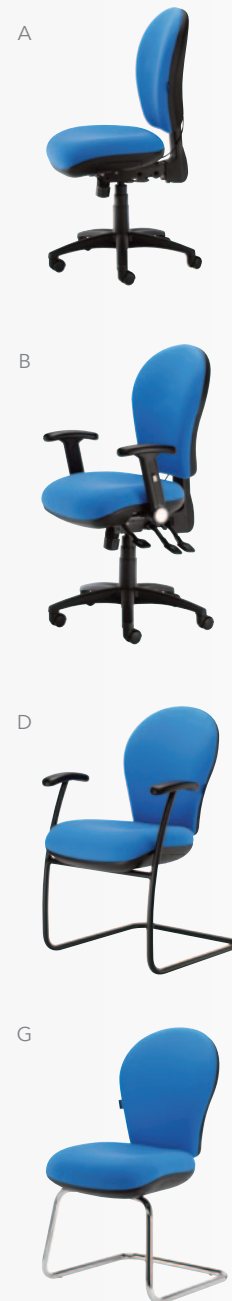

Westminster task chair

- Brilliant value for money task chair
- Highly ergonomic
- Contoured seat and back
- Heavy duty back
- Independent mechanism adjusts seat and back separately



A. YHYP1	Chair, Black Components	£316.00
B. YHYP1A	Chair, Black Components w/Adj Arms	£359.00
C. YHYP1V	Visitor/Conference Chair	£220.00
D. YHYP1VA	Visitor/Conference Chair w/Arms	£301.00
E. YHYP2	Task Chair With Chrome Components	£361.00
F. YHYP2A	Task Chair Chrome w/Adjustable Arms	£408.00
G. YHYP2V	Visitor/Conference Chair in Chrome	£239.00
F. YHYP2VA	Visitor/Conference Chair in Chrome w/Frame Arms	£342.00



Unlimited fabrics available

Prices shown are for Era, Phoenix, Rivet & Advantage – see pages 288-290. Please contact us for prices on other fabrics

* Please specify fabric colour Please choose synchronised or independent mechanism

For seat dimensions see pages 284-287

Task Seating

Strike

- Stylish Task chair
- Full back upholstered all round
- Stable star base with easy roll castors
- Synchronised mechanism

YTRA17*	Task Chair (No Arms)	£339.00
YTRA17A*	Task Chair with Adjustable Arms	£398.00
YTRA18*	Chrome Task Chair (No Arms)	£382.00
YTRA18A*	Chrome Task Chair with Adjustable Arms	£421.00
YTWOT	Extra Charge for 2-Tone Fabrics from Band 1	£31.00

* Please specify fabric colour



Unlimited fabrics available

Prices shown are for Era, Phoenix, Rivet & Advantage – see pages 288-290. Please contact us for prices on other fabrics

For seat dimensions
see pages 284-287

Comfort chair

- The Ergonomically designed Task chair with large seat & back
- Three lever mechanism - Dual Control, Mechanism weight tension control, Thunder base
- Rubber Castors
- Pump up lumbar
- Ratchet back
- Seat slide
- Black or Chrome components
- Flame retardant foams
- Class 4 gas stem up to 25 stone/150 kilos

YCOML	Chair Black Base	£258.00
YCOMLAA	Chair Black Base & Adj. Arms	£285.00
YCOMLFA	Chair Black Base & Folding Arms	£302.00
YCOMLC	Chair Chrome Base	£274.00
YCOMLAAC	Chair Black Chrome & Adj. Arms	£309.00
YCOMLFAC	Chair Black Chrome & Folding Arms	£325.00



Unlimited fabrics available

Prices shown are for Era, Phoenix, Rivet & Advantage – see pages 288-290. Please contact us for prices on other fabrics

5 Year
Warranty



Task Seating

Arrow executive chair

- High back executive style chair at incredible value
- Superb back support
- Pump up lumbar support
- Adjustable seat and back angle
- Height adjustable arms and headrest available
- Available with chrome base & arms POA
- 5 year guarantee

A. YAIF2	Visitor/Conference Chair, Black Frame	£327.00
B. YAIF2A	Visitor/Conference Chair w/Arms, Black Frame	£405.00
C. YAIF3	Visitor/Conference Chair with Chrome Frame	£346.00
D. YAIF3A	Visitor/Conference Chair with Chrome Frame and Arms	£404.00
E. YAIF81	Executive Chair - No Arms	£354.00
F. YAIF81ADJ	Executive Chair With Adjustable Arms	£424.00
G. YAIF91ADJHR	Executive Chair With Adjustable Arms & Headrest	£511.00

Options

YAIFAP	Polished Aluminium Base (Task Chairs Only)	+£77.00
YAIFCF	Additional Cost for Chrome Cantilever Frame	+£21.00
YAIFCFA	Additional Cost for Chrome (Conference Chair with Arms)	+£39.00
YAIFMF	Arrow Optional Memory Foam Seat	+£79.00
YAIFSS	Arrow Optional Seat Slider	+£37.00

Genuine Leather Options

YAIF2AL	Leather Conference Chair with Arms	£881.00
YAIF2L	Leather Conference Chair	£799.00
YAIF81ADJL	Leather Executive Chair With Adjustable Arms	£901.00
YAIF81L	Genuine Leather Executive Chair	£856.00
YAIF91ADJHRL	Leather Executive Chair, Adjustable Arms & Headrest	£984.00



5 Year
Warranty



Unlimited fabrics available

Prices shown are for Era, Phoenix, Rivet & Advantage – see pages 288-290. Please contact us for prices on other fabrics

Page Link - see pages

For
fabric
swatches

188-291



For seat dimensions
see pages 284-287

Manager & Executive Seating

Gorgio

- Sleek high back executive chair
- Height adjustable arms with sliding arm pads
- Four position synchronised mechanism
- Side tension control
- Polished Aluminium base



Y610500	Gorgio Managers Chair	£373.00
---------	-----------------------	---------



Racer

- A stylish high back executive chair featuring a five locking position synchronized mechanism aluminium base, aluminium arms and PU arm pads

YRAC01	Black Managers Chair	£344.00
--------	----------------------	---------

Page Link - see page

Executive
conference
seating



Washington managers chair

- Faux leather executive chair with leather padded steel arms
- Black with standard tilt lock
- Deep cushioned seat with waterfall front for increased comfort
- Gas lift adjustment with tension control
- Panel stitched design to seat & back with mesh inserts
- Raised Chrome spider base

YWA01BK		£471.00
---------	--	---------

Manager & Executive Seating

Chelsea managers chair

- A superb high back executive chair
- Five locking position synchronized mechanism
- Aluminium base and arms
- PU arm pads
- Matching cantilever available (see page 283)

YCHEL01	Chelsea Managers Chair	£344.00
---------	------------------------	---------

For seat dimensions
see pages 284-287

Knightsbridge executive chair

- Premium faux leather back & seat
- Polished aluminium arms & mechanism
- Moulded foam seat pad
- Integrated operating levers
- Triple position tilt lock

YKNIGHTBK	Knightsbridge Executive Chair	£490.00
-----------	-------------------------------	---------



Francisco executive chair

- 24 hour ergonomic padded seat and back for enhanced comfort
- Chrome 5 star base with twin wheel hooded castors
- Fully adjustable arms with adjustable headrest
- Oversized high back leather effect executive office chair
- Smart looking, elegant leather chair with dual layer seat and back cushions
- Waterfall seat aids circulation and removes pressure on the thighs

YFRAN24BK	Francisco Executive Chair	£650.00
-----------	---------------------------	---------





Ergonomic &
Backcare
Range

For seat dimensions
see pages 284-287

A
Shown with
chrome base
option



B
Shown with fold
down arms & chrome
base option



C
Shown with
chrome disc
fixed arms



D
Shown with
chrome height
adjustable
arms



E
Shown with chrome
height adjustable
arms



F
Shown with
chrome disc fixed
arms



Ergonomic Backcare Seating

Ergotek task chair

- Physiotherapist approved ergonomic back care chair
- Ratchet back height adjustment
- Deep moulded foam for superior user comfort
- Compliant with HSE seating at work directives
- SATRA tested to BS 5459 level S severe use
- Weight capacity 150kg, cantilever 110 kg
- Seat Slide

Ergotek

A. YERGM	Mid Back Task Chair	£343.00
B. YERGH	High Back Task Chair	£376.00

Ergotek+ Larger, fully upholstered cut foam back

C. YERGMV	Mid Back Visitor Cantilever Chair	£254.00
D. YERGP	High Back Task Chair	£462.00
E. YERGPH	High Back Task Chair with Headrest	£533.00
F. YERGPV	High Back Visitor Cantilever Chair	£395.00

Arm Options

G. YERGAA	Black Height Adjustable Arms	+£44.00
H. YERGAC	Black Fixed Arms	+£34.00
I. YERGAD	Chrome Height Adjustable Arms	+£88.00
J. YERGAH	Chrome Disc Fixed Arms	+£27.00
K. YERGAM	Height adjustable Fold Down Arms	+£117.00

Base Options

L. YERGB2	Black Nylon Spider Base	+£52.00
M. YERGB3	Chrome Base	+£62.00
N. YERGB5	Polished Aluminium Base	+£89.00

Ergo Options

YERGCC	Coccyx Cut-Out (Ergotek+ Only)	+£25.00
YERGL	Inflatable Lumbar Support	+£50.00



Unlimited fabrics available
Prices shown are for Era, Phoenix, Rivet & Advantage – see pages 288-290. Please contact us for prices on other fabrics



Ergonomic Backcare Seating

Redwood

- Certified to BS 5459, the patented floating lumbar and pelvic support system and intuitive controls mean users of most sizes, shapes and weights get support and dynamic movement the moment they sit in the Redwood
- This chair has all our standard ergonomic advantages and upgradable options that enable the Redwood to cater for users up to 150KG
- This chair is ideal for 24/7 use
- Thoracic Support (upper back & shoulders)
- Floating lumbar and pelvic supporting lower back
- Locking height-adjustable aluminium back
- Direct tension control
- Dual-pivot mechanism
- Waterfall seat for behind the knee comfort
- Fully adjustable 4D arms
- Optional adjustable headrests
- Pictorial buttons – simple and easy to adjust
- Available in a unique Fabric or Mesh Seat
- Premium Mesh or Leather seat options available POA

YREDWM	Mesh Seat & Back	£690.00
YREDWMHR	Mesh Seat & Back with Headrest	£726.00
YREDWF	Fabric Seat & Mesh Back	£690.00
YREDWFHR	Fabric Seat & Mesh Back with Headrest	£726.00

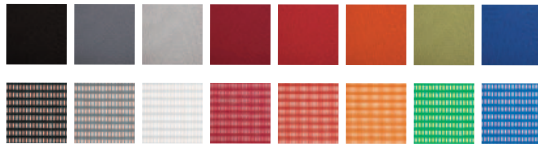

Fabric Options

Mesh Options

Rheos chair

- Wellbeing in the workplace is vital for maximising organisational performance. The Rheos ergonomic chair range has been designed to address the daily physiological problems experienced by office workers
- Large seat with integral coccyx cut out
- Weight activated synchronised mechanism
- Integral seat slide
- Fine tension adjustment
- 5 degree forward seat tilt
- 4 position tilt lock
- Additional 13 degree back angle adjustment
- 2D or 4D arm options
- Black nylon, black aluminium or polished aluminium base

YRHE01	Rheos Wellbeing Medium back chair
YRHE02	Rheos Wellbeing High back chair
YRHE2D	Optional Extra 2D Adjustable Arms
YRHE4D	Optional Extra 4D Adjustable Arms
YRHELU	Optional Extra Inflatable Lumbar Support
YRHEHR	Optional Extra Headrest



Unlimited fabrics available

Prices shown are for Era, Phoenix, Rivet & Advantage – see pages 288-290. Please contact us for prices on other fabrics



New Product

For seat dimensions see pages 284-287





Conference Seating

Mercury wood frame visitor

- High quality moulded wood frame
- Light Oak effect frame
- 535mm wide
- Stacks 4 high

YVIS04*	Mercury Beech Side Chair	£156.00
YVIS04A*	Mercury Beech Armchair	£162.00
YTWOT	Extra Charge for 2-Tone Fabrics from Band 1	£31.00

* Please specify fabric colour



Unlimited fabrics available

Prices shown are for Era, Phoenix, Rivet & Advantage – see pages 288-290. Please contact us for prices on other fabrics



Westbury

- Stylish solid wood frame chair ideally suited for a variety of locations
- Stacks 4 high
- Coated in hygienilac anti-bacterial laquer
- 5 year guarantee (normal use)

YWES01	Westbury Wood Frame Side Chair	£257.00
YWES02	Westbury Wood Frame Armchair	£319.00

* Please specify fabric colour



Unlimited fabrics available

Prices shown are for Era, Phoenix, Rivet & Advantage – see pages 288-290. Please contact us for prices on other fabrics



Define

- Attractive boardroom chair
- One piece seat and back
- Clear lacquered frame
- 5 year guarantee

YDHAT01*	Define 4 Leg Chair	£235.00
YTWOT	Extra Charge for 2-Tone Fabrics from Band 1	£31.00

* Please specify fabric colour



Unlimited fabrics available

Prices shown are for Era, Phoenix, Rivet & Advantage – see pages 288-290. Please contact us for prices on other fabrics

5 Year
Warranty

For seat dimensions
see pages 284-287

Conference Seating

Venus deluxe beech framed

- Suited for visitors or management suites
- Fully upholstered waterfall seat
- Stylish curved frame
- Stacks 4 high

YVIS06* Venus Beech Chair £235.00

YTWOT Extra Charge for 2-Tone Fabrics
from Band 1 £31.00

* Please specify fabric colour



Unlimited fabrics available

Prices shown are for Era, Phoenix, Rivet & Advantage – see pages 288-290. Please contact us for prices on other fabrics



5 Year
Warranty

Best
Seller

Cosmos wood frame visitor

- Elegant stacking side or arm chairs
- Crafted hard wood frame
- 5 year guarantee
- Stacks 4 high

YCM05* Cosmos Stacking Side Chair £209.00

YCM05A* Cosmos Armchair £229.00

* Please specify fabric colour



Unlimited fabrics available

Prices shown are for Era, Phoenix, Rivet & Advantage – see pages 288-290. Please contact us for prices on other fabrics



For seat dimensions
see pages 284-287

Finley wooden frame side chair

- Solid wood legs, lacquered natural ash
- The inner (seating part) and outer shells can be upholstered
- A striking contrast can be created by mixing the inner shell in one of the fabrics with the outer shell a different fabric option
- Available in other frame options POA

YFINWFC Wooden Frame Side Chair £483.00



Unlimited fabrics available

Prices shown are for Era, Phoenix, Rivet & Advantage – see pages 288-290. Please contact us for prices on other fabrics



New
Product



Conference Seating

Franklin chair

- Strong, fully upholstered chair
- Ideal for 6th Form and College use
- 5 year warranty
- Optional tablet can be fitted left or right
- Black frame as standard – other frame colours available POA

YFKLR1	Franklin Side Chair	£132.00
YFKLR1W	Franklin Side Chair w/Writing Tablet	£231.00



College fleet heavy duty chair

- Heavy duty chair designed for use in colleges and higher education
- Narrower design allowing 2 chairs to fit under 1200mm wide classroom table
- Stackable

		1-19	20+
YCOFL	Chair	£108.00	POA
YCOFLWT	Chair with Writing Tablet	£178.00	POA

Delivery charge for quantities of less than 10 chairs

Narrower design allowing 2 chairs to fit under 1200mm wide classroom table

For seat dimensions see pages 284-287

5 Year Warranty



Fleet plus

- Classic conference chair with added quality
- Mesh back chair with fabric upholstered seat
- Arm writing tablets available POA



		1-9	10+
YFP500MB*	Mesh Back Chair	£108.00	£98.00

* Please specify fabric colour

Conference Seating

Fleet



- A collection of multipurpose stacking chairs suitable for conference, meeting and training rooms, public waiting areas, canteens and schools
- Features include comfortable deep foam, three dimensional waterfall seat, plastic feet to eliminate floor scratching with a choice of black or chrome steel frames
- Stackable up to eight high
- If using with classroom tables, please use the College Fleet chair shown opposite as it is narrower

		1-9	10+
A. YVIS13	Chair with Black Frame	£73.00	£65.00
B. YVIS15	Chair With Chrome Frame	£77.00	£69.00
YVISP1BK	Chair with Black Moulded Plastic Seat and Back	£64.00	£58.00
YVISP2R	Chair with Red Moulded Plastic Seat and Back	£64.00	£58.00
YVISP3BL	Chair with Blue Moulded Plastic Seat and Back	£64.00	£58.00
YVISP4G	Chair with Green Moulded Plastic Seat and Back	£64.00	£58.00
YVISP5P	Chair, Upholstered Seat and Perforated Plastic Back	£83.00	£75.00
C. YVIS16	Fleet Wood Chair	£112.00	£101.00

Options

YFLETA	Optional Arms	+£32.00	+£29.00
YVIS17	Optional Writing Tablet	+£44.00	+£40.00
YVISWFA	Writing Tablet & 1 Arm	+£66.00	+£59.00
YFLETLD	Fixed Linking Device (Pair)	+£11.00	+£10.00

Please specify fabric colour

Colour Options Unlimited fabrics available
Prices shown are for Era, Phoenix, Rivet & Advantage – see pages 288-290. Please contact us for prices on other fabrics

For seat dimensions see pages 284-287

Fast Track Chair - in stock for faster delivery



Fleet fast track

- Stocked in Black BK, Royal Blue RB, Claret CL

	1-19	20+
YFLEFT	£50.00	£45.00

Fleet Fast Track Chair Fabric Options

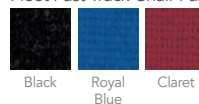

Optional Linking Device



A



Fleet with Black Frame

Best Seller
Express Delivery

B



Fleet with Chrome Frame

C



Fleet Wood Chair



Fleet with Optional Arms



Fleet with Writing Tablet & 1 Arm



Conference Seating

Bayonne cantilever chair

- Popular Cantilever Chrome meeting chair
- Stacks 4 high
- Other frame colours available POA

YBAYCC	Bayonne Cantilever Chair	£186.00
--------	--------------------------	---------



E



Belgravia chair

- The new Belgravia chair is a modern, contemporary multi-purpose design, suitable for a wide range of commercial and hospitality environments. Perfect for hotel and leisure, break out spaces and reception, board rooms and meeting rooms
- Available with Wooden 4 leg, Aluminium 4 Star Rocking, 5 star Chrome base with castors, 4 Star Polished Aluminium with castors, 4 Leg Black Manhattan Base, 4 Leg Polished Manhattan Base or 4 leg Black Manhattan base with castors
- Available in Single colour or 2-tone

A. YBELW4L	Wooden 4 Leg	£315.00
B. YBELB4LM	4 Leg, Black Manhattan Base	£357.00
C. YBELALUM4STAR	4 Star Polished base	£347.00
D. YBELALUMMBC	With Polished 4 Leg Manhattan Base on Castors	£368.00
E. YBELALUM	With 4 Leg Manhattan Base	£357.00
F. YBELBLM	With Black 4 Leg Manhattan Base on castors	£368.00
G. YBEL5STAR	With 5 Star Chrome base on Castors	£368.00
YTWOT	Extra Charge for 2-Tone Fabrics from Band 1	£31.00

A



B



C



D



F



G



Conference Seating

Neptune chair

- Range of comfortable yet stylish boardroom chairs
- Available in Full back, Small back & Mesh back
- Chrome frame as standard
- Desk clearance of 645mm
- Stacks up to 4 high
- Mesh back available in 7 colours: - Black, Blue, Green, Grey, Orange, Red or White. Please specify at time of order

Full back chair

YNEPFB4	4 legged Chrome frame with arms	£198.00
---------	---------------------------------	---------

YNEPFB4	4 legged Chrome frame with arms	£198.00
YNEPFB4	Conference Chair Cantilever frame w/arms	£198.00

Small back chair

YNEPSB4	4 legged chrome frame with arms	£186.00
---------	---------------------------------	---------

YNEPSB4	4 legged chrome frame with arms	£186.00
YNEPSB4	Cantilever chrome frame with arms	£186.00

Mesh back chair

YNEPMH4	4 legged chrome frame with arms	£202.00
---------	---------------------------------	---------

YNEPMH4	4 legged chrome frame with arms	£202.00
YNEPMH4	Cantilever chrome frame with arms	£202.00



Unlimited fabrics available

Prices shown are for Era, Phoenix, Rivet & X2 - see pages 288-290. Please contact us for prices on other fabrics.



Track

- Stacking chair
- Writing tablet option

A. YTRAC1*	Track 4 Leg Chair	£155.00
------------	-------------------	---------

B. YTRACPP	Track 4 Leg Chair with Polypropylene Arms	£185.00
------------	---	---------

YTRAC4C	Track Chrome Frame for 4 Leg Chairs	+£29.00
---------	-------------------------------------	---------

C. YTRACCA*	Track Cantilever Chair with Arms	£243.00
-------------	----------------------------------	---------

YTRACCR	Track Chrome Frame for Cantilever Chair	+£31.00
---------	---	---------

* Please specify fabric colour



Unlimited fabrics available

Prices shown are for Era, Phoenix, Rivet & Advantage - see pages 288-290. Please contact us for prices on other fabrics.



For seat dimensions
see pages 284-287

New
Product

A. Society Chairs

Where elegance meets durability and versatility. Our chairs are thoughtfully designed to provide exceptional comfort, enhanced ventilation and flexibility.

- Stackable: 4 Leg and Sled Base chairs can be conveniently stacked up to 8 high (6 if upholstered), 12 on a dolly allowing for easy storage and space optimisation
- Society chairs available as 4-Leg, Sled Base, 4-Leg on Castors, HD, with tablet arm & with arms
- Colour Options: 8 polypropylene seat and backrest colours
- Frames available in Black, Blue Grey and Cool Grey
- High Density chairs (HD) stack up to 32 on transport dolly (25 if upholstered)



Frame & Poly Colours

Black

Blue Grey

Cool Grey



Cool Grey

Blue Grey

Grass Green

Black

Nordic Blue

Flannel

Surf's Up

Cayenne



Code	Seating Style	1-29 Units	30+ Units
YSOC4L	4-Leg	£122.00	POA
YSOC4LC	4-Leg on Castors	£136.00	POA
YSOC4LA	4-Leg with Arms	£151.00	POA
YSOC4LCA	4-Leg on Castors With Arms	£168.00	POA
YSOCSLED	Sled Base	£132.00	POA
YSOCHD	High Density Chair	£120.00	POA
YSOC4LTA	4-Leg with tablet arm	£304.00	POA



B. Society Task Chairs

Innovative and versatile our 360 swivelling tablet arm enhances comfort.

- Colour Options: 8 polypropylene seat and backrest colours
- Opt for a polypropylene or a fully upholstered seat
- Tablet arms are made with 15mm BB/BB birch ply board, finished with Ash Nebula laminate surface, and a two-coat lacquer edge



C. Society Task Stools

Perfectly blending style and durability, it boasts a sleek chrome footing, base and glides for elevated support.

- Colour Options: 8 polypropylene seat and backrest colours
- Opt for a polypropylene or a fully upholstered seat
- Available with glides only



D. Society Stools

Maximise space and convenience with our stackable stools, accommodating up to 4 high, including upholstered options.

- Colour Options: 8 polypropylene seat and backrest colours, frames available in 3 colours.
- Opt for a polypropylene or a fully upholstered seat.
- Foot rail added for comfort and practicality.



Code	Seating Style	1-29 Units	30+ Units
YSOCTC	Task Chair	£183.00	POA
YSOCTCTA	Task Chair with Tablet Arm	£364.00	POA
YSOCTSG	Task Stool	£225.00	POA
YSOC4LS	Stool	£175.00	POA
YSOCUPH	Upholstered Seat (band 1)	+£53.00	+POA



Conference Seating

Cathedral chair

- The Cathedral chair combines comfort and stackability
- Lightweight
- Stacks 10 high or 25 high on Cathedral trolley

		1-19	20+
YCATH	Chair	£114.00	POA
YCATHTR	Trolley	£344.00	n/a

* Please specify colour



Unlimited fabrics available

Prices shown are for Era, Phoenix, Rivet & Advantage – see pages 288-290. Please contact us for prices on other fabrics



For seat dimensions
see pages 284-287



Icon chair

- Versatile Chair that ensures adaptability in all situations
- Available in 6 colours
- Stacks 30 chairs high on a trolley
- Optional extra seat pad available
- Also available in a Skid base stool - POA

YICONLI	Icon Chair in Lime	£122.00
YICONOC	Icon Chair in Ocean	£122.00
YICONBK	Icon Chair In Black	£122.00
YICONRD	Icon Chair in Red	£122.00
YICONSL	Icon Chair in Slate	£122.00
YICONWH	Icon Chair in White	£122.00
YICONUP	Icon Chair with Upholstered Seat	£151.00
YICONT	Stacking Trolley	£416.00



Conference Seating

Kraft

- Sled frame training and conference chair
- Silver frame, Chrome available

A. YKRA1	Black Plastic Sidechair	£123.00
B. YKRA1S	Upholstered Seat Sidechair	£176.00
C. YKRA1F	Fully Upholstered Sidechair	£204.00
D. YKRA2	Black Plastic Sidechair w/Arms	£176.00
E. YKRA2S	Upholstered Seat Sidechair w/Arms	£237.00
F. YKRA2F	Fully Upholstered Sidechair w/Arms	£259.00
G. YKRA3	Black Plastic Sidechair with Writing Tablet	£205.00
H. YKRA3S	Upholstered Seat Chair with Writing Tablet	£264.00
I. YKRA3F	Fully Upholstered Chair with Writing Tablet	£290.00
J. YKRATR	Kraft Trolley (Chairs not Included)	£313.00
	YKRACF Additional Cost for Chrome Frame	+\$25.00

* Please specify fabric colour



Unlimited fabrics available

Prices shown are for Era, Phoenix, Rivet & Advantage – see pages 288-290. Please contact us for prices on other fabrics



5 Year Warranty



J



For seat dimensions see pages 284-287



Conference Seating

Stax

High density stacking chair

- Chrome wire frame
- Stacks up to 40 high
- Integral linking on all chairs
- Weight capacity 200kg
- New colour range
- Stacking trolley available
- Also Available with Seat Pad – POA

Y600535	Midnight Blue	£126.00
Y600545	Traffic Black	£126.00
Y600555	Anthracite Grey	£126.00
Y600565	Grass Green	£126.00
Y600575	Soft Red	£126.00

Stax trolley

- Stacks 32 chairs high in 2 metres

Y600740	£336.00
---------	---------

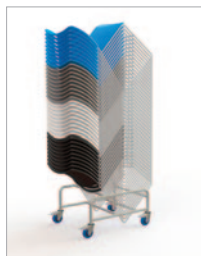

Roma

A contemporary and comfortable stacking chair

- Stacks up to 38 chairs on a dolly
- Ideal chair for when seating is required on a large scale
- A popular choice for halls, meeting areas and classrooms
- Available in Black, Flannel and Nordic as standard, all other colours available to order POA.

		1-29	30+
Y16716	Roma Chair	£99.90	POA
Y16728	Transport Dolly	£283.80	POA
Y100310	Optional Linking Plastic Glides	£9.90	POA

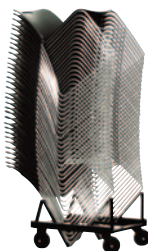
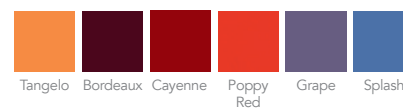
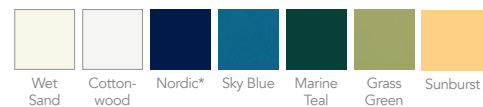

Removable left or right handed tablet arm



Upholstered seat pad

For seat dimensions see pages 284-287

Conference Seating

Fusion

- Stackable
- Chrome frame
- Writing tablet and linking device available - please enquire
- Optional seat and back pads available
- Available in Red, Blue, Black, White, Green, Brown and Grey - please specify when ordering

4 Leg Chair

YFUS1	4 Leg Chair	£182.00
YFUS1UPH	With Upholstered Seat	£194.00
YFUS1UPHSB	With Upholstered Seat & Back	£208.00
YFUS1A	Frame 4 Leg Chair with Arms	£266.00

Skid Base Options

YFUS2	Sled Base Chair	£157.00
YFUS2UPH	With Upholstered Seat	£230.00
YFUS2UPHSB	With Upholstered Seat & Back	£256.00

4 Leg Chair with Castors

YFUS3C	4 Leg Chair with Castors	£187.00
YFUS3CUPH	With Upholstered Seat	£201.00
YFUS3CUPHSB	With Upholstered Seat & Back	£212.00

4 Leg High Stool

YFUS1B	High Stool	£267.00
YFUS1BUPH	With Upholstered Seat	£279.00

Chair Trolley

YFUSTR	Chair Trolley	£329.00
--------	---------------	---------



For seat dimensions
see pages 284-287



New
Product



Conference Seating

A. Evergreen

- Those who prefer practical chairs with natural design details can choose Evergreen version with an ashwood base which complements perfectly the plastic seat with a classical silhouette. Wood always adds some extra warmth and cosiness to any interior space. Chair legs are available in two colour options: light grey-stained or black-stained ashwood
- Available with 4 Leg or Castors
- Plastic seat colour options: - Avocado Green, Dusty Rose, Black or Grey
- Optional Extra Fabric Seat Pad

YESPC002	Natural Ash Wood 4 Leg	£369.00
YESPC002B	Black Ash Wood 4 Leg	£369.00
YESPC011	Pyramid Base on Castors	£466.00
YESPUPH	Upholstered Seat Pad	£466.00



Narvik upholstered

- Fully upholstered chair
- Deep foamed seat for extra comfort
- Hand-crafted from sustainable timber
- Robust construction, ideal for contract and retail locations
- Available in Natural Oak
- Choice of fabrics, vinyls and leathers

Y600580	Oak Frame Upholstered Chair	£351.00
Y600590	Oak Frame Upholstered Stool	£540.00



Unlimited fabrics available

Prices shown are for Era, Phoenix, Rivet & Advantage – see pages 288-290. Please contact us for prices on other fabrics

For seat dimensions
see pages 284-287



Molde wooden

- Comfortable contoured seat
- Available in Natural Oak
- Wooden Plyform seat
- Seat colours Black, White, Blue, Red, Orange, Yellow, Lime Green, Purple & anthracite

Y600610	Plyform Seat Chair	£315.00
Y600620	Plyform Seat Stool	£500.00

Conference Seating

Topaz

- Chrome frame chair with upholstered inner back and plastic back outer
- Weight capacity 110kg

YTOP1U	4 Legs	£209.00
YTOP1UA	4 Legs & Arms	£268.00
YTOP2UA	Cantilever Frame & Arms	£316.00

* Please specify fabric colour



Unlimited fabrics available

Prices shown are for Era, Phoenix, Rivet & Advantage – see pages 288-290. Please contact us for prices on other fabrics



5 Year
Warranty

Topaz mesh

- Chrome frame chair with upholstered seat and mesh back
- Weight capacity 110kg

YTOP1M	4 Legs	£290.00
YTOP1MA	4 Legs and Arms	£345.00
YTOP2MA	Cantilever Frame & Arms	£400.00
YTOPTR	Trolley (for 4 Leg Options Only)	£166.00

* Please specify fabric colour



Unlimited fabrics available

Prices shown are for Era, Phoenix, Rivet & Advantage – see pages 288-290. Please contact us for prices on other fabrics



5 Year
Warranty

For seat dimensions
see pages 284-287

Topaz mobile

- Chrome Frame chair on castors
- Available with Upholstered back or Mesh back

YTOPWM	Mesh Back	£330.00
YTOPWU	Upholstered Back	£262.00
YTOPWMA	Mesh Back & Arms	£399.00
YTOPWUA	Upholstered Back & Arms	£320.00



Unlimited fabrics available

Prices shown are for Era, Phoenix, Rivet & Advantage – see pages 288-290. Please contact us for prices on other fabrics



Executive Conference Seating

Eames style chair

- The Eames Style executive chair and matching visitors chair is perfect for adding a touch of style to your office or conference room. The classic black ribbed faux leather design is available with a high back or medium back and will add some much-needed comfort to employees and visitors, with Chrome arms and a chrome base that will always looking sleek and stylish
- Contemporary design with top quality black faux leather
- Front support feet for anti-tilt
- Matching leather executive chair available
- Stylish chrome arms & cantilever frame
- Stylish, classic design suitable for any office or meeting room
- Weight capacity 115kg



YEAMC	Eames Style Cantilever Chair	£299.00
-------	------------------------------	---------



Washington

- Deep cushioned seat with waterfall front for increased comfort
- Executive faux leather visitor chair
- Front support feet for anti-tilt
- Leather padded steel arms
- Panel stitched design to seat & back with mesh inserts
- Stylish Chrome cantilever frame

YWAC02BK	Washington Cantilever Chair	£445.00
----------	-----------------------------	---------



Charles cantilever meeting chair

- Chrome Cantilever Meeting Chair
- Sculptured Back Support
- Black Faux Leather
- Anti-tilt Stabilising Frame Feet

YCHCMC	Charles Cantilever Chair	£148.00
--------	--------------------------	---------

Executive Conference Seating

Chelsea

- A superb quality cantilever chair
- Aluminium base and arms
- PU arm pads

YCHEL02	Chelsea Cantilever Chair	£238.00
---------	--------------------------	---------



5 Year
Warranty

Racer

- Stylish cantilever chair
- Black PU

YRAC02	Racer Cantilever Chair	£217.00
--------	------------------------	---------



For seat dimensions
see pages 284-287

Mayfair directors boardroom chair

- Mayfair chairs are exquisite and stylish, thus can perfectly represent company in meeting and guest areas. Quite often in a bigger executive office, there is some space devoted for meetings. A composition of Mayfair executive and visitor chairs is a harmonious and modern combination, which will surely make a good impression
- Available with or without arms
- Ask for Unique Leather Swatch
- 4 leg Polished Aluminium Base

YMAYDC	Directors Chair	£1346.00
--------	-----------------	----------

YMAYDMA	Directors Chair with Arms	£1745.00
---------	---------------------------	----------



Code	o/a height	o/a width	o/a depth	seat height	Code	o/a height	o/a width	o/a depth	seat height	Code	o/a height	o/a width	o/a depth	seat height
Reception & Staffroom Seating					YJUP01MU	930	750	780	420	YMERPLA	890	620	640	430
					Page 229					YMERPH	980	570	680	430
					YJASMU	760	580	550	425	YMERPHA	980	620	680	430
					YJASBL	760	580	550	425	YAMSC	830	590	600	450
					YJASGR	760	580	550	425	YAMAC	855	620	600	430
					YJASPERBL	860	650	800	425	YAM2S	880	1370	500	460
					YJASPERGR	860	650	800	425	Page 234				
					YJASPERMU	860	650	800	425	YREC10BK	770	700	630	455
					YJULRBBL	730	690	725	320	YREC10CH	770	700	630	455
					YJULPLBL	730	690	725	320	YREC102BK	770	1290	630	455
					YJULRBCR	730	690	725	320	YREC102CH	770	1290	630	455
YJULPLCR	730	690	725	320	Y600100	770	680	490	490					
Page 225					Page 230					Y600102	770	1100	610	490
YREC25W	740	575	710	400	YIVYPYRAMID	760	600	620	420	YYSTRUMPET	790	725	620	-
YREC26W	740	625	710	400	YIVYCHROME4STAR	760	600	620	420	YSSQUARE	790	725	620	-
YREC27W	740	625	710	400	YIVYCHROMESLEIGH	760	600	620	420	YSSPIDER	790	725	620	-
YREC28W	740	675	710	400	YAZLBW	820	725	710	395	Page 235				
YREC29W	740	1250	710	400	YAZLBBM	815	725	685	390	YLEG1B	840	720	680	460
YREC31W	740	670	670	400	YAZHBBM	1285	805	805	395	YLEG2B	840	1240	680	460
YREC32W	740	570	720	400	YAZHBBM	1280	805	785	390	YLEG1C	840	720	680	460
YREC33W	740	570	720	400	Page 231					YLEG2C	840	1240	680	460
YREC32LW	740	620	720	400	YALYLBW	870	620	570	460	YPSL1	790	640	630	440
YREC32RW	740	620	720	400	YALYLB4	870	620	570	460	Page 236				
YREC33LW	740	620	720	400	YALYHBBW	1000	700	770	460	YVIV01	840	460	460	510
YREC33RW	740	620	720	400	YALYH4B	1000	700	770	460	YVIV02	840	460	460	510
YREC04W	330	620	620	-	YASTLOWWW	770	840	840	470	YJAVA01	450	1220	460	450
YREC04G	330	620	620	-	YASTLOWASTAR	770	740	740	470	YJAVAST	225	440	440	-
Page 226					YASTLOWSPIRAL	770	740	740	470	YJAVA	350	750	750	-
YHOR01	890	580	820	410	YASTHIGHW	1100	840	840	470	Page 237				
YHOR01LA	890	680	820	410	YASTHIGH4STAR	1100	740	740	470	YTIG1	860	590	-	420
YHOR01RA	890	680	820	410	YASTHIGHSPIRAL	1100	770	770	470	YTIG2	860	590	-	420
YHORA	890	780	820	410	YASTCOFFEE	430	600	600	-	YTIG3	860	590	-	420
YHOR02	890	490	820	410	Page 232					YTIG4	860	590	-	420
YHOR03	890	660	820	410	YRALI	820	520	660	410	YTIG5	365	750	-	-
YHORCBE	300	770	770	-	YIMP1	810	520	670	410	YCON2	810	570	560	430
YHORCMA	300	770	770	-	YIMPA	810	630	670	410	YCON3	810	570	560	430
YHORCOA	300	770	770	-	YCC50	890	570	660	440	YCON4	820	570	560	470
YHORCFB	300	770	770	-	YCC55	890	650	660	440	YCONS	780	570	560	-
Page 227					YCC255	890	1160	660	440	Page 238				
YSWI1	800	580	660	440	YCC20	350	550	550	-	YVAL01	830	785	810	440
YSWI1A	810	650	670	450	YCC30	350	1100	550	-	YVAL02	830	1325	810	440
YSWIT	400	580	580	-	Page 233					YVAL03	830	1870	810	440
Page 227					YMER1A	745	590	690	420	YBARB1	790	880	810	420
YMOT1	730	580	745	395	YMER1AA	745	640	690	420	YBARB2	790	1450	810	420
YMOTTS	330	620	620	-	YMER1RA	745	620	690	420	YBARB3	790	2005	810	420
YMOTTG	330	620	620	-	YMER1LA	745	620	690	420	Page 239				
YMOTTLA	730	660	745	395	YMER2AA	745	1175	690	420	YSA001F	730	830	730	440
YMOTTRA	730	660	745	395	YMER1M	890	590	735	420	YSA002F	730	1370	730	440
YMOTTA	730	740	745	395	YMER1MA	890	640	735	420	YSA003F	730	1900	730	440
Page 228					YMER1MRA	890	620	735	420	YSA001L	730	830	730	440
YJA01LG	750	780	670	340	YMER1MLA	890	620	735	420	YSA002L	730	1370	730	440
YJA01MB	750	780	670	340	YMER2MA	890	1320	735	420	YSA003L	730	1900	730	440
YJA02LG	750	1490	670	430	YMER1H	1020	590	770	420	YCHESERFIELDS	760	1065	865	-
YJA02MB	750	1490	670	430	YMER1HA	1020	640	770	420	YCHESTERFIELD	760	1625	865	-
YJOR01DG	710	670	700	410	YMERPL	890	570	640	430	YCHESTERFIELDT	760	1980	865	-
YJOR01LB	710	670	700	410										
YJUP01DB	930	750	780	420										

Code	o/a height	o/a width	o/a depth	seat height	Code	o/a height	o/a width	o/a depth	seat height	Code	o/a height	o/a width	o/a depth	seat height
Page 240					Page 245					Page 248				
Y600110	770	800	720	440	YWHIS4	1200	800	820	440	Y620100	2035	1215	750	-
Y600115	1300	800	720	440	YWHIS2	1200	1150	820	440	Y620105	2035	2060	750	-
Y600120	770	1200	720	440	YWHIS3	1200	1100	820	440	Y620110	2035	2060	1400	-
Y600125	1300	1200	720	440	YCITB1	-	600	670	440	Y620115	2200	2060	750	-
Y600130	770	1600	720	440	YCITDB1	-	1200	670	440	Y620120	2200	2060	1382	-
Y600135	1300	1600	720	440	YCITTB1	-	1800	670	440	Page 249				
Y600140	770	800	800	440	YCIT1	-	600	670	440	Y620200	1820	2236	700	-
Y600145	1300	800	800	440	YCIT2	-	1200	670	440	Y620205	1820	2236	1300	-
Y600150	770	1500	800	440	YCIT3	-	1800	670	440	Y620210	1820	2236	2100	-
Y600155	1300	1500	800	440	YCIT4	-	1090	670	440	Y620220	1524	2236	701	-
Y600160	770	800	1320	440	YCITC1	-	770	770	440	Y620225	1524	2236	1300	-
Y600165	1300	800	1320	440	YCITCON1	-	1090	670	440	Page 250				
Page 241					YCITTAB2	-	880	880	440	Y620300	1168	1854	1335	-
Y600170	770	1200	1320	440	YRLB1	80	672	775	460	Y620305	1168	1854	1335	-
Y600175	1300	1200	1320	440	YRLB10	1390	672	815	460	Y400120	450	450	450	-
Y600180	770	1600	1320	440	YRLB10A	1390	1110	815	460	Y400122	450	1100	450	-
Y600185	1300	1600	1320	440	YRLB110AL	1390	890	815	460	Y400124	450	1750	450	-
Y600190	770	1080	720	440	YRLB12A	1390	1030	815	460	Y400128	450	1368	908	-
Y600195	1300	1080	720	440	YRLB15A	1390	1110	815	460	Y400130	450	1828	908	-
Y600200	770	1080	1320	440	YRLB15AL	1390	891	815	460	Y400132	450	2287	908	-
Y600205	1300	1080	1320	440	YRLB15AR	1390	891	815	460	Y400136	450	1333	1215	-
Y600210	440	1320	660	440	YRLB1A	820	1030	775	460	Page 251				
Y600220	770	1080	720	440	YRLB1AL	820	851	775	460	YLU21	390	525	525	390
Y600225	1300	1080	720	440	YRLB1AR	820	851	775	460	YLU22	390	760	525	390
Page 242					YRLB2	820	1332	775	460	YLU23	390	760	-	390
YRAF1	460	670	715	450	YRLB20	1390	1332	815	460	YLU24	390	525	525	390
YRAF1B	830	670	715	450	YRLB20A	1390	1770	815	460	YLU25	390	1080	-	390
YRAF1BR	830	800	715	450	YRLB20AL	1390	1551	815	460	YLU26	390	870	525	390
YRAF1BL	830	800	715	450	YRLB20AR	1390	1551	815	460	YLU27	390	525	460	390
YRAF1BA	830	900	715	450	YRLB22A	1390	1690	815	460	YLU28	390	870	460	390
YRAF1CB	830	715	715	450	YRLB25A	1390	1770	815	460	YLP21	490	525	525	490
YRAF2	460	1340	715	450	YRLB25AL	1390	1551	815	460	YLP22	490	760	525	490
YRAF2B	830	1340	715	450	YRLB25AR	1390	1551	815	460	YLP23	490	760	-	490
YRAF2BR	830	1455	715	450	YRLB2A	820	1690	775	460	YLP24	490	525	525	490
YRAF2BL	830	1455	715	450	YRLB2AL	820	1511	775	460	YLP25	490	1080	-	490
YRAF2BA	830	1570	715	450	YRLB2AR	820	1511	775	460	YLP26	490	1035	525	490
YRAF3	460	715	715	450	YRLB3	820	1812	775	460	YLP27	490	525	525	490
YRAFT	430	700	700	-	YRLB30	1390	1812	815	460	YCWAYHU	750	663	522	-
YRAF3B	810	1840	715	-	YRLB30A	1390	2250	815	460	YCWAYLU	450	663	522	-
YRAF3BA	810	2100	715	-	YRLB30AL	1390	2031	815	460	Page 246				
Page 243					YRLB30AR	1390	2170	815	460	YCHATLD	780	3000 diameter	450	
YRAFH1	1300	670	715	450	YRLB35A	1390	2250	815	460	YCHATMDB	1350	3000 diameter	450	
YRAFH1R	1300	800	715	450	YRLB35AL	1390	2031	815	460	YCHATHBD	2000	3000 diameter	450	
YRAFH1L	1300	800	715	450	YRLB35AR	1390	2031	815	460	YCHATCT	750	1000 diameter	-	
YRAFH1S	1300	900	715	450	YRLB3A	820	2170	775	460	Page 247				
YRAFH2	1300	1340	715	450	YRLB3AL	820	1991	775	460	YQRS	2238	1170	1205	-
YRAFH2R	1300	1455	715	450	YRLB3AR	820	1991	775	460	YQRD	2238	2148	1205	-
YRAFH2L	1300	1455	715	450	Page 248					YQRQ	2238	2776	1975	-
YRAFH2S	1300	1570	715	450	Y609800	2320	1500	1968	-	Y609801	2320	2110	1968	-
YRAFHCV	1300	1190	715	450	Page 249					Page 250				
YRAFHCV	1300	1190	715	450	Page 250					Page 251				
YRAFHCV	1300	1190	715	450	Page 251					Page 252				
YRAFHCV	1300	1190	715	450	Page 252					Page 253				
YRAFHCV	1300	1190	715	450	Page 253					Page 254				
YRAFHCV	1300	1190	715	450	Page 254					Page 255				
YRAFHCV	1300	1190	715	450	Page 255					Page 256				
YRAFHCV	1300	1190	715	450	Page 256					Page 257				
YRAFHCV	1300	1190	715	450	Page 257					Page 258				
YRAFHCV	1300	1190	715	450	Page 258					Page 259				
YRAFHCV	1300	1190	715	450	Page 259					Page 260				
YRAFHCV	1300	1190	715	450	Page 260					Page 261				
YRAFHCV	1300	1190	715	450	Page 261					Page 262				
YRAFHCV	1300	1190	715	450	Page 262					Page 263				
YRAFHCV	1300	1190	715	450	Page 263					Page 264				
YRAFHCV	1300	1190	715	450	Page 264					Page 265				
YRAFHCV	1300	1190	715	450	Page 265					Page 266				
YRAFHCV	1300	1190	715	450	Page 266					Page 267				
YRAFHCV	1300	1190	715	450	Page 267					Page 268				
YRAFHCV	1300	1190	715	450	Page 268					Page 269				
YRAFHCV	1300	1190	715	450	Page 269					Page 270				
YRAFHCV	1300	1190	715	450	Page 270					Page 271				
YRAFHCV	1300	1190	715	450	Page 271					Page 272				
YRAFHCV	1300	1190	715	450	Page 272					Page 273				
YRAFHCV	1300	1190	715	450	Page 273					Page 274				
YRAFHCV	1300	1190	715	450	Page 274					Page 275				
YRAFHCV	1300	1190	715	450	Page 275					Page 276				
YRAFHCV	1300	1190	715	450	Page 276					Page 277				
YRAFHCV	1300	1190	715	450	Page 277					Page 278				
YRAFHCV	1300	1190	715	450	Page 278					Page 279				
YRAFHCV	1300	1190	715	450	Page 279					Page 280				
YRAFHCV	1300	1190	715	450	Page 280					Page 281				
YRAFHCV	1300	1190	715	450	Page 281					Page 282				
YRAFHCV	1300	1190	715	450	Page 282					Page 283				
YRAFHCV	1300	1190	715	450	Page 283					Page 284				
YRAFHCV	1300	1190	715	450	Page 284					Page 285				
YRAFHCV	1300	1190	715	450	Page 285					Page 286				
YRAFHCV	1300	1190	715	450	Page 286					Page 287				
YRAFHCV	1300	1190	715	450	Page 287					Page 288				
YRAFHCV	1300	1190	715	450	Page 288					Page 289				
YRAFHCV	1300	1190	715	450	Page 289					Page 290				
YRAFHCV	1300	1190	715	450	Page 290					Page 291				
YRAFHCV	1300	1190	715	450	Page 291					Page 292				
YRAFHCV	1300	1190	715	450	Page 292					Page 293				
YRAFHCV	1300	1190	715	450	Page 293					Page 294				
YRAFHCV	1300	1190	715	450	Page 294					Page 295				
YRAFHCV	1300	1190	715	450	Page 295					Page 296				
YRAFHCV	1300	1190	715	450	Page 296					Page 297				
YRAFHCV	1300	1190	715	450	Page 297					Page 298				
YRAFHCV	1300	1190	715	450	Page 298					Page 299				
YRAFHCV	1300	1190	715	450	Page 299					Page 300				
YRAFHCV	1300	1190	715	450	Page 300					Page 301				
YRAFHCV	1300	1190	715	450	Page 301					Page 302				
YRAFHCV	1300	1190	715	450	Page 302					Page 303				
YRAFHCV	1300	1190	715	450	Page 303					Page 304				
YRAFHCV	1300	1190	715	450	Page 304					Page 305				
YRAFHCV	1300	1190	715	450	Page 305					Page 306				
YRAFHCV	1300	1190	715	450	Page 306					Page 307				
YRAFHCV	1300	1190	715	450	Page 307					Page 308				
YRAFHCV	1300	1190	715	450	Page 308					Page 309				
YRAFHCV	1300	1190	715	450	Page 309					Page 310				
YRAFHCV	1300	1190	715	450	Page 310					Page 311				
YRAFHCV	1300	1190	715	450	Page 311					Page 312				
YRAFHCV	1300	1190</												

Code	o/a height	o/a width	o/a depth	seat height	Code	o/a height	o/a width	o/a depth	seat height	Code	o/a height	o/a width	o/a depth	seat height
Page 252					YMELRZA	990	650	610	475-605	YCHE01A	1045	640	600	510-590
YHPCCT600	410	600	600	-	YMELRFA	990	650	610	475-605	YCHEC01D	1045	660	600	510-590
YHPCCT700	410	700	700	-	YMELBK	1050	540	660	465	Page 261				
YHPCSCCT66	410	600	600	-	YMELC	1050	540	660	465	YHY P1	1120	510	-	500-600
YHPCSCCT77	410	700	700	-	YMMHM	950	500	550	475-605	YHY P1A	1120	670	-	500-600
YHPCT66	410	600	600	-						YHY P1V	990	540	540	490
YHPCT77	410	700	700	-						YHY P1VA	990	540	590	490
YHPCT86	410	800	600	-						YHY P2	1120	510	-	500-600
YHPCT95	410	900	500	-						YHY P2A	1120	670	-	500-600
YTGCT600	410	600	600	-						YHY P2V	990	540	540	490
YTGCT700	410	700	700	-						YHY P2VFA	990	540	620	490
YTGCSCT66	410	600	600	-						Page 262				
YTGCSCT77	410	700	700	-	YMMHMA	950	620	550	475-605	YTRA17	1070	535	570	510-630
YTGCT66	410	600	600	-	YMMHMZA	950	650	550	475-605	YTRA17A	1070	690	570	510-630
YTGCT77	410	700	700	-						YTRA18	1070	535	570	510-630
YTGCT86	410	800	600	-						YTRA18A	1070	690	570	510-630
YTGCT95	410	900	500	-						YCOML	1125	550	650	-
YREC04W	330	620	620	-						YCOMLAA	1125	660	650	-
Page 253					Page 258					YCOMLFA	1125	660	650	-
YTRUCC	505	600	600	-	YCHI1B	955	500	570	475-605	YCOMLFC	1125	550	650	-
Y600390	505	600	600	-	YCHI1BFX	955	620	570	475-605	YCOMLAAC	1125	660	650	-
Y600400	505	1000	600	-	YCHI1BAD	955	650	570	475-605	YCOMLFAAC	1125	660	650	-
YZZN603	400	600	800	-	YCHI1BFA	955	640	570	475-605	YCOMLFAAC	1125	660	650	-
YZZN100	400	600	1000	-	YCHI1C	955	500	570	475-605	Page 263				
YZZN651	400	650	650	-	YCHI1CAD	955	625	570	475-605	YAIF2	1040	540	630	490
YCINN070	480	700	700	-	YCHI1CFA	955	640	570	475-605	YAIF2A	1040	620	630	490
YCINN071	480	700	700	-	YCHI2B	1095	500	570	620-870	YAIF3	1040	620	630	490
Operator Seating					YCHI2BAD	1095	650	570	620-870	YAIF3A	1040	620	630	490
Page 254					YCHI2BFA	1095	640	570	620-870	YAIF81	1105	530	-	450-550
YEMAG01B	930	580	510	430-550	Y600300	1050	520	600	-	YAIF81ADJ	1105	660	-	450-554
YBREL B	1250	520	630	480-610	Y600301	1050	520	660	-	YAIF91ADJHR	1280	660	-	450-552
YBRELBA	1250	640	630	480-610	Y600302	1050	520	660	-	YAIF2AL	1040	620	630	490
YBRELAAJ	1250	670	630	480-610	Y600303	1050	520	600	-	YAIF2L	1040	540	630	490
Page 255					Page 259					YAIF81ADJL	1105	660	-	450-554
Y20106	860	500	550	475-605	YWAVEMADJ	1160	700	480	475-595	YAIF81L	1105	530	-	450-553
Y20111	860	620	550	475-605	YBV32	1065	490	550	-	YAIF91ADJHRL	1280	660	-	450-555
Y20113	860	650	550	475-605	YBV32ADJ	1065	640	550	-	Manager & Executive Seating				
Y20108	970	500	550	475-605	YBVC30	1040	490	550	-	Page 264				
Y20110	970	620	550	475-605	YBVEX30	1025	630	580	-	Y610500	1230	660	610	460-560
Y20112	970	650	550	475-605	YBV40	915	550	570	-	YRAC01	1210	650	620	480-560
Y20301	1110	500	570	620-870	YBV40A	915	600	570	-	YWA01BK	1230	675	785	490-555
Y20201	980	540	660	465	YBV50	915	550	570	-	Page 265				
Page 256					YBV50A	915	600	570	-	YCHEL01	1170	690	650	460-545
YGLSHB	1170	-	-	450-580	Task Seating					YKNIGHTBK	1085	680	680	440-525
YGLSHMA	1170	-	-	450-580	Page 260					YFRAN24BK	1225	665	695	480-550
YGLSHAT	1170	-	-	450-580	YTRA11	1030	520	600	510-590	Page 266				
YMPS66	1000	520	630	480-610	YTRA11FA	1030	640	600	510-590	YERGM	1180	510	-	515-630
YMPS66FA	1000	640	630	480-610	YTRA11A	1030	640	600	510-590	YERGH	1250	510	-	515-630
YMPS66ADJ	1000	670	630	480-610	YTRA12	1030	520	600	510-590	YERGMV	940	510	-	510
Page 257					YTRA12FA	1030	640	600	510-590	YERGP	1290	520	-	545-660
YMELR	990	500	460	475-605	YTRA12A	1030	640	600	510-590	YERGPH	1290	520	-	545-660
YMELRA	990	620	610	475-605	YTRA12A	1030	640	600	510-590	YERGPV	1060	520	-	545-660
					YCHE01A	1045	520	600	510-590					
					YCHE01D	1045	660	600	510-590					
					YCHE01AA	1045	640	600	510-590					
					YCHE01AD	1045	660	600	510-590					
					YCHE02	1045	520	600	510-590					
					YCHE02F	1045	640	600	510-590					

Phoenix

- Phoenix is a simple crepe weave fabric
- Available in 21 top selling colours
- Made from 100% polyester
- This hardwearing fabric is rated at 100,000 Martindale abrasion cycles



Please phone for a free swatch

Due to limitations in the printing process when fabric is shown photographically, we recommend that you ask for actual fabric samples before ordering.

Standard Fabrics Range



Task seating



Cigarette & Match



Year Guarantee

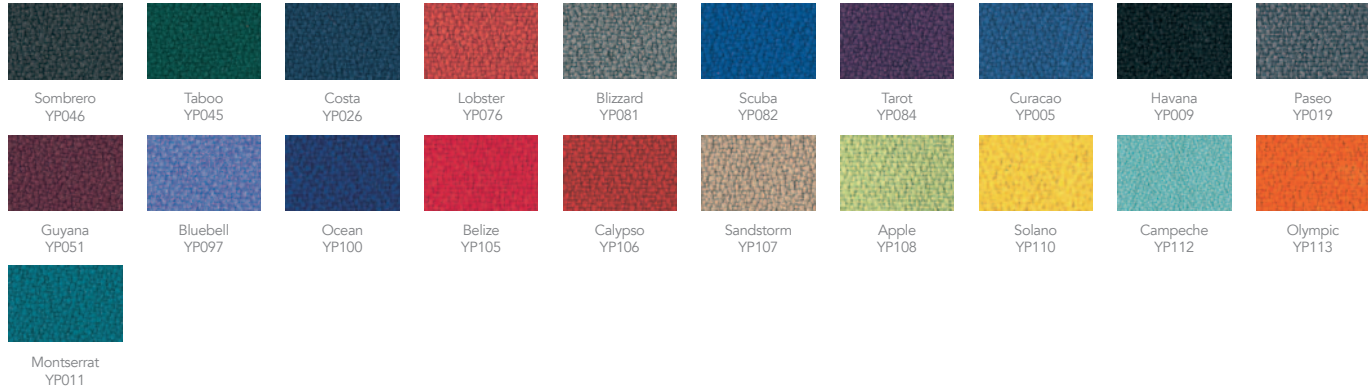

Rivet

- Rivet is a fixating fabric which connects with the modern collaborative workplace and forms a bridge between textile traditions and future innovation.
- Rivet is a lightly textured hopsack which emulates the swathe of suiting in a well-heeled synthetic. Made from 100% REPREVE®, a brand of recycled polyester made from used plastic bottles.



Task seating



Soft seating



Cigarette & Match



Washable



environmental



year guarantee

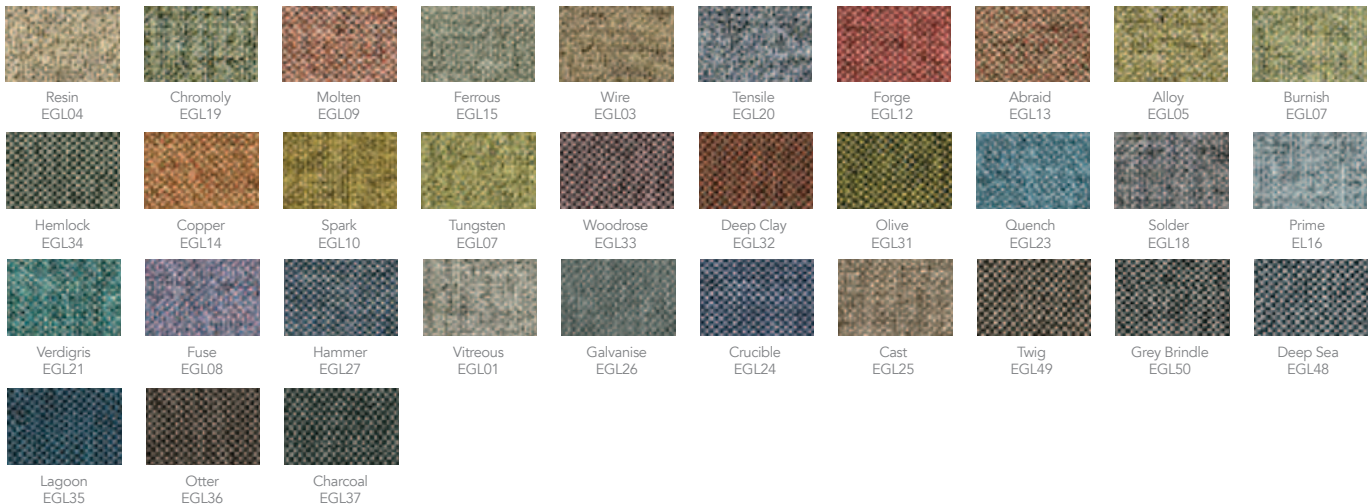

For a wider range of fabric options, please call us today.

Standard Fabrics Range

Era

- Era is a subtle, two tone polyester fabric containing stretch in both directions for ease of upholstery.
- The baby herringbone weave offers an understated contemporary texture while its colouring technique provides close up intrigue. The palette incorporates playful brights and sophisticated muted tones.



Task seating



Soft seating



Cigarette & Match

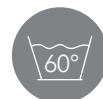

Washable



10 year guarantee

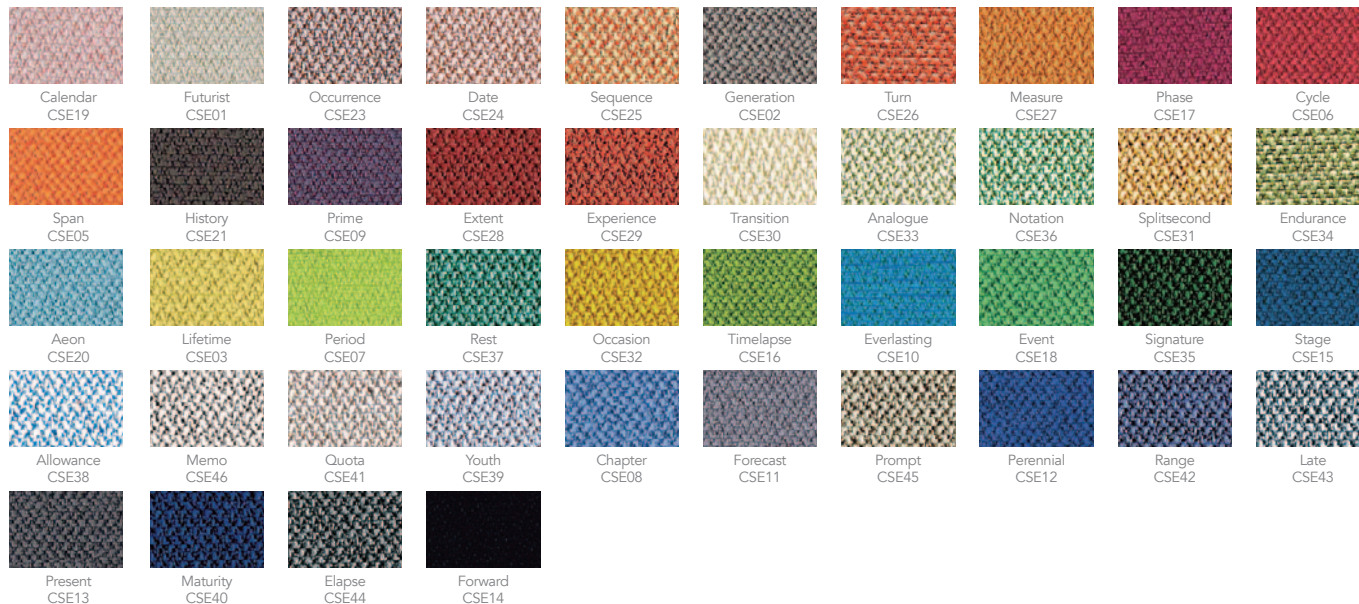

Advantage

- Advantage is the UK's top selling Low Hazard seating fabric
- Its high performance durability comes from its blend of 30% wool and 70% gymlene - a synthetic fibre originally developed for use in broadloom carpets
- It is rated at 75,000 Martindale abrasion cycles



Task seating



Cigarette & Match



5 Year Guarantee



For a wider range of fabric options, please call us today.

Premium fabrics - ALL SEATING IN THESE FABRICS AVAILABLE POA

Special Fabrics Range

Intervene performance fabric



Task seating



Soft seating



Crib 5



Anti-Microbial



Stain repellent



Water Proof



Bleach Cleanable

10
year guarantee

Intervene plain



YH171



YH096



YH047



YH100



YH046



YH071



YH030

Intervene texture

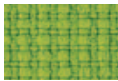

YW200

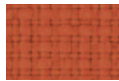

YW076

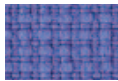

YW208



YW079



YW009



YW211



YW205



YW160



YW209



YW203



YW083



YW027



YW148



YW145

Please phone with your
choice of seating for prices
in these fabrics

X2 plus fabric options



Task seating



Soft seating



Cigarette & Match



Crib 5



environmental

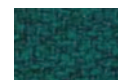
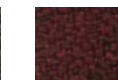
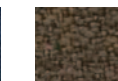
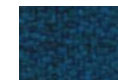

Year Guarantee

Percentage
AK016Number
AK020Ratio
AK001Divide
AK015Algebra
AK005Arithmetic
AK018Add
AK012Subtract
AK013Fraction
AK003Polygon
AK002Multiply
AK014Equation
AK004Acute
AK009Formula
AK017Value
AK006Positive
AK019Median
AK011Calculus
AK008Maths
AK007Metric
AK010Due to limitations in the printing process when fabric is shown photographically,
we recommend that you ask for actual fabric samples before ordering.

Premium fabrics - ALL SEATING IN THESE FABRICS AVAILABLE POA

Special Fabrics Range

Just colours vinyls

Just Colour harmonizes with both contemporary and traditional interiors. The broad palette encompasses modern neutrals, warm classics to vivid bright colours.

Designed to withstand the rigorous demands of both heavy domestic and contract upholstery, Just Colour is suitable for a wide variety of applications.

- Flame Retardancy: BS5852 Ignition Source 5, BS7176 Medium Hazard, S.I. 1988 No. 1324 schedule 4&5, EN1021-1&2, CS-25, FMVSS 302 and IMO A 652 (16)
- Abrasion: 100,000+



Task seating



Soft seating



Crib 5



Anti-Microbial



Stain repellent



Water Proof



Bleach Cleanable



year guarantee

Jasmine White	Scrubs	Purple Rain	Raspberry Crush	Gunmetal Grey	Sunblush	Mikado	Moss	Cocoa	Walnut	Fudge
Rosso	Blue Steel	Magnum	Professor Plum	Dolphin	Jazzberry	Eden	Citrus Green	Pillar Box	Lilac	Dune
Sea Green	Applemint	Damson	Grape	Ultraviolet	Golden Honey	Almond	Sapphire Blue	Cherry Blossom	Rainforest	Mulled Wine
Aquamarine	Ocean Blue	Lupin	Cool Blue	Gingersnap	Tangerine	Marigold	Primrose	Deep Rose	Candy	Bubblegum
Lemon	Cobalt	Battleship	Likoni	Wasabi	Elephant	Rusty	Koala	Rouge	Greyfriar	
Pear	Dijon	Teal	Putty	Fuchsia	Coral	Blackberry	Pecan			

Due to limitations in the printing process when fabric is shown photographically, we recommend that you ask for actual fabric samples before ordering.



Let us create a warm welcome to your school or office.

Clean, flowing lines give a confident, professional impression your visitors are sure to remember. Call us today to discuss your requirements.

Receptions

Wilmington	294
Alfriston	295
Tromsø	296
Venice	297
Venice Ice	298
The Alpen	299
Oval	300
Castello	301
Pescara	302
Lunae	303
Bespoke Receptions & Reception Screens	304
Office Plants	305

Receptions

First impressions count don't they? What do visitors see when they arrive at your school? It needs to be something that endorses the excellence that exists throughout the school, warmly welcomes and is pleasant for staff to work at.

We can help you achieve that in reception areas large and small from a simple one piece unit to a fully bespoke design unique to you.

Let us help you achieve the great result you want – why not call us now and we can begin the process at once.



Due to limitations in the printing process, wood and colour finishes shown throughout the catalogue may not be representative of actual colour. Samples are available on request.



Wilmington

- Ideal for school receptions or libraries, Wilmington counters are beautifully crafted in durable, wood effect melamine
- Traditional look with practical features please ask for specific quote
- Satin anodised kickplate option
- A range of matching pedestals and bookcases is also available

Finishes: Band 1

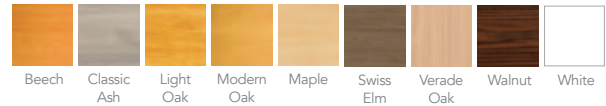

Finishes: Band 2

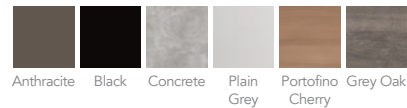

Wood & colour finishes may not be representative of actual colours - please ask for a sample. Other colours available - please enquire.

Page Link - see page
Matching office
desking

318-323



New
Product

Alfriston Range

Whether you value innovation and creativity, tradition and elegance or agility and minimalism, the right reception area creates a lasting visual message.

- The Alfriston range offers pre-designed reception configurations in a choice of 2 finishes – Beech or Beech & White
- High quality front office reception desk units with straight and curved options
- These units can be used to create alternative modular configurations. Ask our design team for more options



A. Medium Straight Reception Unit

500120	W1600 x D800 x H1172mm	£862.00
--------	------------------------	---------

B. Medium Curved Reception Unit

500121	W1800 x D800 x H1172mm	£1,282.00
--------	------------------------	-----------

C. Extra Large U-Shaped Reception Unit

500122	W3200 x D2000 x H1172mm	£3,161.00
--------	-------------------------	-----------

D. Extra Large Curved Reception Unit

500123	W3552 x D2352 x H1172mm	£3,313.00
--------	-------------------------	-----------

E. Large Curved Reception Unit

500124	W2788 x D1224 x H1172mm	£2,050.00
--------	-------------------------	-----------

F. Large Straight Reception Desk

500125	W3600 x D800 x H1172mm	£1,920.00
--------	------------------------	-----------

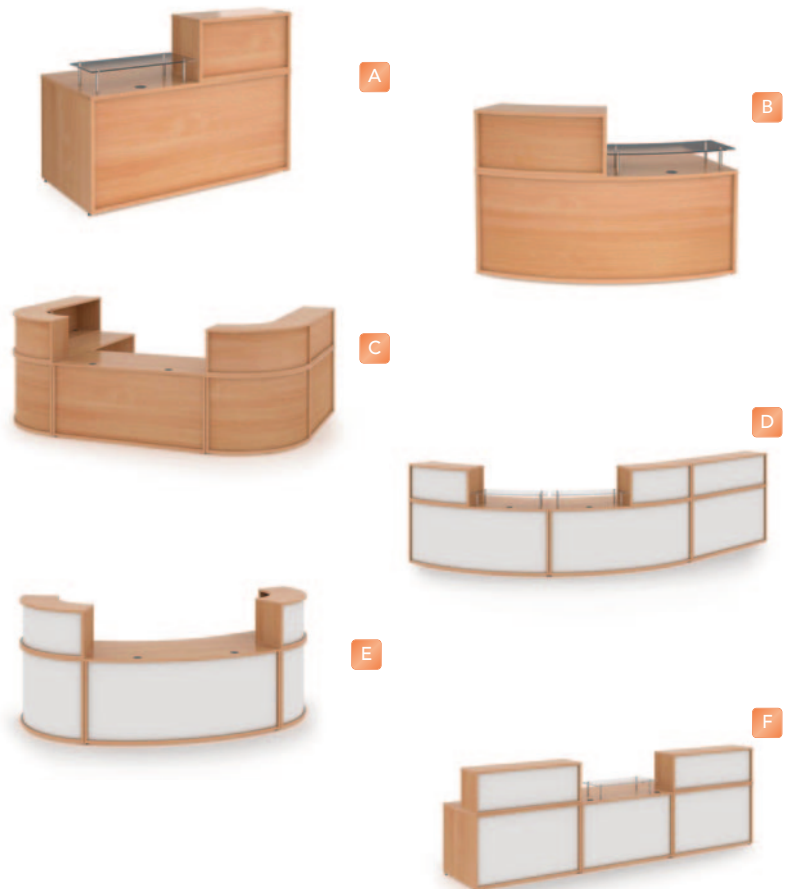



Tromsø

Timeless design in a modern office.

- A flexible modular system available in different shapes, straight and curved, also, in several height combinations for different-sized offices
- Choose from different textures and colours to create your desired style reception: secretive and minimalist or cosy and harmonious



Venice

- Stylish and sleek yet practical, Venice counters are the choice for the discerning school desiring to make a statement
- The option of a glass top and chrome strip detailing enhances the contemporary appeal, showcasing the brilliant white laminate to maximum effect
- Modular construction enables countless configuration options
- Subtle LED lighting adds a sophisticated style and gives the impression the room is bigger





Venice ice

- A range of cool white reception furniture that makes a stunning visual impact and can be enhanced further by the use of low level mood lighting
- Due to a wide range of available elements, the shape of the Venice Ice range can be configured in various forms. From a circle through an arch, to angular or simple blocks
- The body of the counter includes hidden handy shelves and a wide working table with enough space for a computer or printer
- Subtle LED lighting adds a sophisticated style and gives the impression the room is bigger

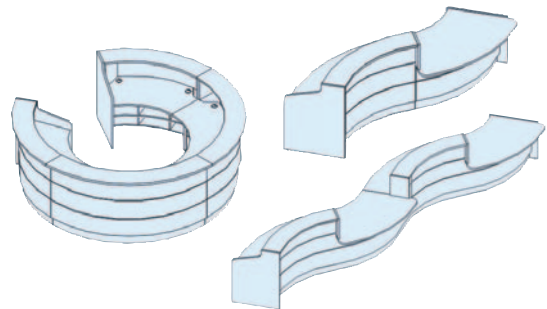



The Alpen

Evoke the feel of nature in your spaces with this reception desk inspired by the shapes of the Alps. Crafted not only to make guests feel welcome but also to suit the demands of a modern reception area. The Alpen integrates functionality with grace and timeless design, gains guests' attention and makes for an atmosphere of comfort and trust.

The high gloss front and timeless colours delight with their severity, which is additionally emphasized by an illuminated metal kick plate. The glass reception combines aesthetics with functionality, and the modular construction creates a variety of straight and corner sets. By employing a low module segment with an overhang top, the reception eases access for disabled users.

Thanks to these features Alpen fulfills the requirements of different types of spaces, from small receptions to large lobbies.



Front, Counter & Body Options



Black
Glass



Silver
Glass

White
Glass



Oval

The Oval is a multifunctional reception desk dedicated to small rooms or entrances where there is minimal space.

- The lowered desk top makes it easy to communicate with persons in a sitting position
- The common part of the desk top is tempered frosted glass, which allows the user to deal with documents easily and provides trouble-free communication
- The lifted part includes a hidden computer stand and a vertical shelf for files and documents
- Available in Cocoa or Chestnut finish panels with white body
- Available left or right handed
- 5 year warranty

Y500100	Oval Right Handed	£1190.00
---------	-------------------	----------

Y500105	Oval Left Handed	£1190.00
---------	------------------	----------

Available in



Chestnut Cocoa White Pastel



Castello

- A refreshing reception system combining high gloss HPL with MFC in a choice of six finishes
- It is a modular solution that allows the creation of compact or large reception counters depending on requirements
- It comes with an optional top highlighted with LED lighting

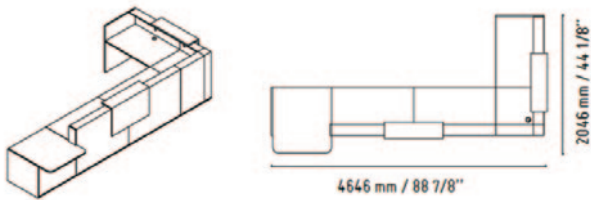

Available in:

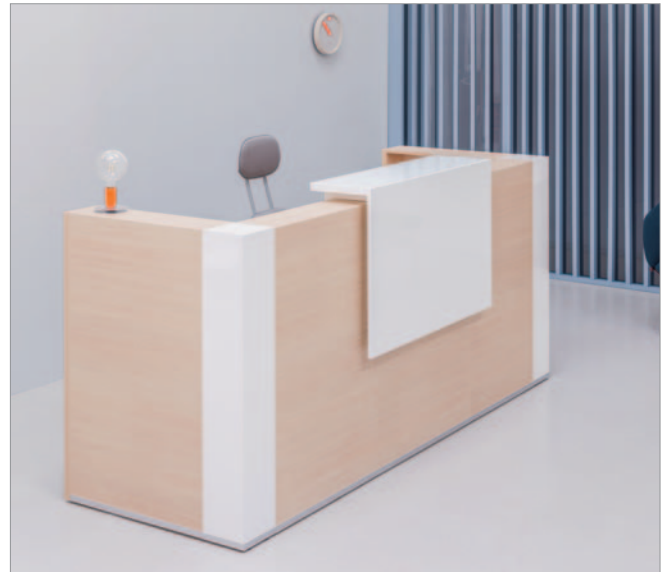
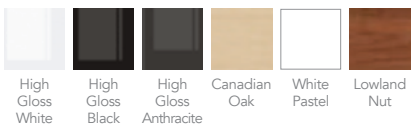



Pescara

Let's be creative! A Unique piece of furniture that will enable you to create a workplace solution tailored to your needs. A large choice of fabric, colours and sizes offers an endless range of combinations.

- Ergonomic workplace – Create an ergonomic workplace using both regular or sit-stand desks. These can be adjusted to a chosen height by employees. This will allow them to periodically change their posture, keeping them active and boosting their level of productivity.
- Cable management solutions – Electrical and internet cables will not get in your way and your desk will be clutter-free

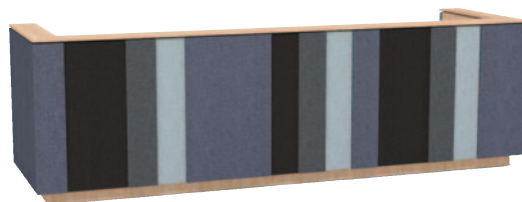



Lunae

Inspired by the demand for compact reception furniture, this crescent shaped desk is ideal. Featuring a genuine wood veneer counter top which tapers from 800mm to 240mm, Crescent desks are able to neatly fit into corners and tight spaces with a small footprint.

For Dramatic visual effect, the veneered top of the Lunae reception furniture can be teamed with a recessed counter front in a contrasting laminate instead of a matching veneer.

Colour adjustable 'mood lighting' fitted under the desk top, looks particularly effective in reception areas with low ambient light.

Finishes available:



Natural Cherry Oak Walnut Cherry 3 Dark Oak





Bespoke Reception Furniture

- We are able to work to your exact requirements or architect's specifications, produced in either real wood veneers or laminated MFC
- At an early stage of planning we cover all aspects including DDA, lighting, induction loop facilities, and then tailor specific finishes, to enhance and create the stunning impression you want to portray
- A huge range of colours and wood finishes are available

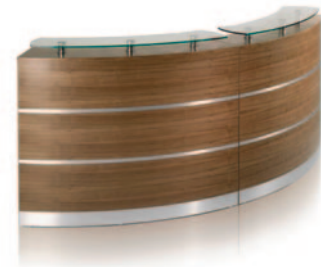

Bespoke Reception Screens

Abuse to reception staff sadly is now a common occurrence faced by educational institutions and the security desk screens help to eliminate the risk to staff

- A bespoke solution enhances security to an existing reception area or as part of a newbuild or renovation project
- Screens can be designed with safeguarding in mind and can help comply with Ofsted recommendations
- A huge range of colours and finishes are available and can include curved or toughened glass



Office Plants

Office plants and interior landscaping are an important element in workspace design. This offers huge benefits to staff engagement and well-being whilst simultaneously enhancing your image to prospective parents, clients and visitors.

This selection of replica plants offers an opportunity to gain all the aesthetic benefits. Replica plants are virtually zero maintenance, made with the finest materials and manufactured with expertise so that most would struggle to tell the difference from the real thing.

There are many benefits to furnishing your office or workspace environment with plants. The introduction of natural forms has been proven to create a calming influence which in turn improves concentration – and ultimately productivity.

If you would prefer the real thing, please get in contact with us.

Table Top Plants

A	Y500214	Phalaenopsis Orchid Display	£64.00
B	Y500215	Vanda Orchid Plant Display	£85.00
C	Y500216	Lavender Plant Display	£48.00
D	Y500217	Boston Fern Plant Display	£48.00
E	Y500218	Green Fern Plant Display	£48.00
F	Y500219	Ivy Plant Display	£33.00

Floor Standing Displays

G	Y500225	Bird of Paradise Plant	£275.00
H	Y500226	Pandanus Plant	£289.00
I	Y500227	Bamboo Plant	£265.00
J	Y500228	Ficus Contract Green Plant	£299.00
K	Y500229	Mother-In-Law Tongue Plant	£284.00
L	Y500230	Dracaena Reflexa Plant	£349.00
M	Y500231	Buxus Ball Plant	£349.00
N	Y500232	Buxus Spiral Plant	£309.00
O	Y500233	Triple Buxus Ball Plant	£388.00

Green Wall Panels

Each wall panel measures approx. 1000 x 1000mm

P	Y500234	Trell8 Green Wall Panel	£165.00
Q	Y500235	Cheviot Green Wall Panel – UV Rated	£289.00
R	Y500236	R8 Green Wall Panel – FR & UV Rated	£439.00

Table Top Plants

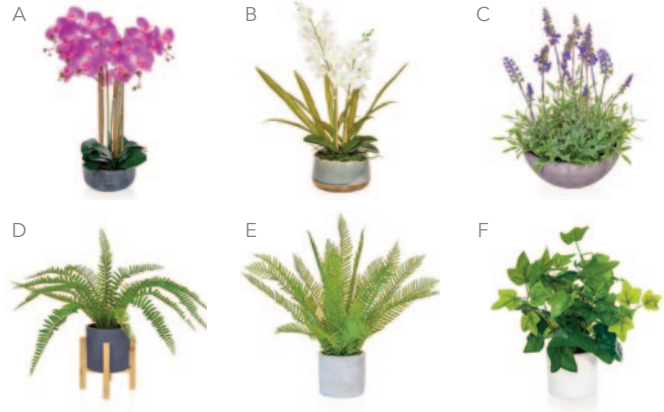

Floor Standing Displays



Green Wall Panels

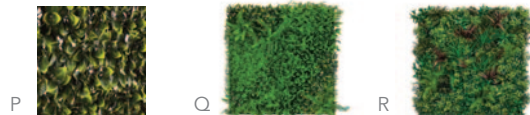



Is your office giving the right Impression?

Talk to us about the best solutions for your offices, meeting rooms, staff work rooms and conference facilities.

Office Furniture

Alpine	308-313, 317-321
Nova	314-316, 350
Wilmington	322-341, 349-350
Arlington Contract	342-343
Chalvington	344-346, 348
Vermont	347
Pigeon Hole Units	349
Arundel	351
Screens	352-353
Cable Management	354-357
Storagewall	358-361
Metal Filing Cabinets	362-363
Metal Cupboards	364-366
Steel Storage	367-370
Safes	371-373

Office Furniture

In the following pages you will find a beautiful and practical choice of tables of every size and type.

Folding and flip-top for multi-use areas, boardroom tables for where it gets serious and much more – let's not forget coffee tables and staff room needs.

Need help planning? – ring us today, we are always delighted to help.



5 Year
Warranty

Alpine Panel Leg Desking

A complete and versatile range of well-priced, traditionally styled office furniture.

- 25mm work tops with 3mm edging, solid 25mm leg and modesty panels
- Six finishes to choose from and a range of matching pedestals, storage and meeting tables (see other pages)
- Cable trays also available (see page 353)
- Prices shown are for Group 1 finish

Straight workstations

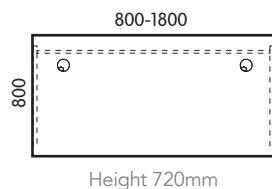

Wave workstations 1000mm deep

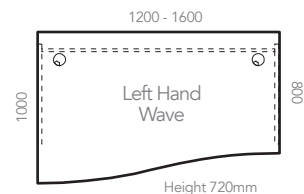

800mm deep also available

		Group 1	Group 2
YDDA081	L800mm	£235.00	£259.00
YDDA101	L1000mm	£249.00	£274.00
YDDA121	L1200mm	£272.00	£299.00
YDDA141	L1400mm	£289.00	£319.00
YDDA161	L1600mm	£315.00	£347.00
YDDA181	L1800mm	£332.00	£366.00

			Group 1	Group 2
YDDL122	Left	L1200mm	£301.00	£332.00
YDDR122	Right	L1200mm	£301.00	£332.00
YDDL142	Left	L1400mm	£324.00	£357.00
YDDR142	Right	L1400mm	£324.00	£357.00
YDDL162	Left	L1600mm	£339.00	£375.00
YDDR162	Right	L1600mm	£339.00	£375.00

Crescent workstations

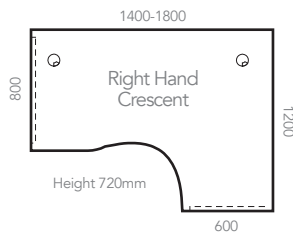

Workstation extensions

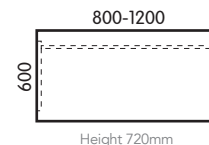

			Group 1	Group 2
YDDL141	Left	L1400 x W1200mm	£399.00	£439.00
YDDR141	Right	L1400 x W1200mm	£399.00	£439.00
YDDL161	Left	L1600 x W1200mm	£424.00	£466.00
YDDR161	Right	L1600 x W1200mm	£424.00	£466.00
YDDL181	Left	L1800 x W1200mm	£458.00	£504.00
YDDR181	Right	L1800 x W1200mm	£458.00	£504.00
YDDB120	Symmetrical Corner	L1200 x W1200 x D600mm	£347.00	£382.00

		Group 1	Group 2
YDDD082	L800mm	£185.00	£203.00
YDDD102	L1000mm	£195.00	£214.00
YDDD122	L1200mm	£219.00	£241.00

COMPLETE ALPINE RANGE

Cantilever Leg Desks	310	Nova Bench Desking	315-316
Pedestals	317	Meeting Tables	312
Conference Tables	314		



Alpine Tables MFC Finishes

Group 1 Colours

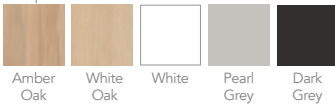

Wood & colour finishes may not be representative of actual colours - please ask for a sample

Group 2 Colours

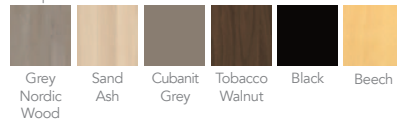

Page Link - see pages

For
Teacher's
Desks



Alpine Cantilever Leg Desking

A superb range of cantilever twin leg desking. This attractive range includes almost 30 different desk shapes and sizes to fit every situation. Quality 25mm tops in a choice of seven finishes.

- Prices shown are for Group 1 finish
- Frames are also available in a white finish - please ask

5 Year
Warranty



Straight workstations

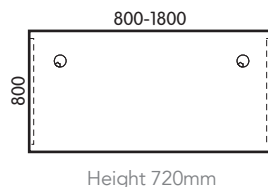

Height 720mm

Wave workstations 1000

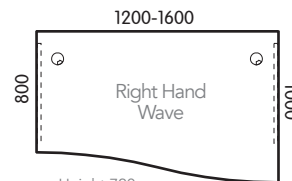

Height 720mm

800mm deep also available POA

		Group 1	Group 2
YDCA081	L800mm	£264.00	£289.00
YDCA101	L1000mm	£284.00	£312.00
YDCA121	L1200mm	£305.00	£335.00
YDCA141	L1400mm	£319.00	£351.00
YDCA161	L1600mm	£347.00	£381.00
YDCA181	L1800mm	£368.00	£404.00

			Group 1	Group 2
YDCL122	Left	L1200mm	£333.00	£365.00
YDCR122	Right	L1200mm	£333.00	£365.00
YDCL142	Left	L1400mm	£356.00	£390.00
YDCR142	Right	L1400mm	£356.00	£390.00
YDCL162	Left	L1600mm	£374.00	£410.00
YDCR162	Right	L1600mm	£374.00	£410.00

Crescent workstations

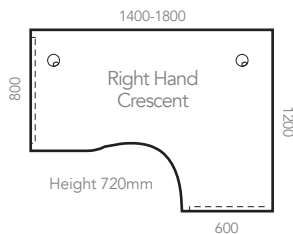

Height 720mm

600

			Group 1	Group 2
YDCL141	Left	L1400 x W1200mm	£438.00	£481.00
YDCR141	Right	L1400 x W1200mm	£438.00	£481.00
YDCL161	Left	L1600 x W1200mm	£463.00	£508.00
YDCR161	Right	L1600 x W1200mm	£463.00	£508.00
YDCL181	Left	L1800 x W1200mm	£490.00	£538.00
YDCR181*	Right	L1800 x W1200mm	£490.00	£538.00
YDCB120	Symmetrical Corner	L1200 x W1200 x D600mm	£399.00	£437.00

Plastic push-fit leg insert

Smart triple compartment vertical cable trunk, push fits into leg.

Recommended for use with modesty fix cable trays - see page 353



YOEVCRW	W100 x H600mm	White	£22.00
YOEVCRS	W100 x H600mm	Silver	£22.00

Workstations extensions

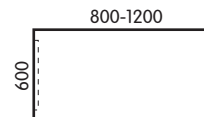

Height 720mm

			Group 1	Group 2
YDCD081	L800mm		£219.00	£240.00
YDCD101	L1000mm		£234.00	£255.00
YDCD121	L1200mm		£261.00	£285.00

COMPLETE ALPINE RANGE

Panel Leg Desks	308	Nova Bench Desking	315-316
Pedestals	317	Meeting Tables	312
Conference Tables	314		

Alpine Tilt Top Tables

TABLES - TILT TOP

700MM DEEP

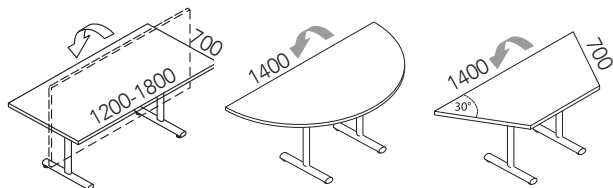

With silver tilt-top base with castors

		Group 1	Group 2
YDFT122	Rectangular Table, 2 Leg, W1200	£462.00	£508.00
YDFT142	Rectangular Table, 2 Leg, W1400	£479.00	£526.00
YDFT162	Rectangular Table, 2 Leg, W1600	£499.00	£545.00
YDFT182	Rectangular table, 2 Leg, W1800	£524.00	£574.00
YDFT183	Half Round Table, 2 Leg, W1400	£474.00	£521.00
YDFT185	Trapezoid Table, 2 Leg, W1400	£492.00	£541.00



Alpine Tables MFC Finishes

Group 1 Colours

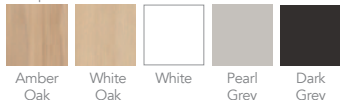

Group 2 Colours

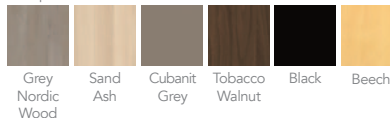

Wood & colour finishes may not be representative of actual colours - please ask for a sample

Table connector



Y660960 pk 2 £40.00

Page Link - see page
Alpine Coffee Tables
255



800MM DEEP

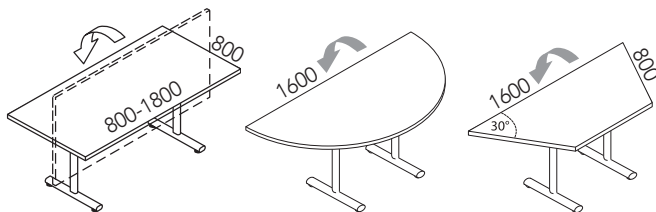

With silver tilt-top base with castors

		Group 1	Group 2
YDFT121	Rectangular Table, 2 Leg, W1200	£499.00	£545.00
YDFT141	Rectangular Table, 2 Leg, W1400	£521.00	£569.00
YDFT161	Rectangular Table, 2 Leg, W1600	£548.00	£598.00
YDFT181	Rectangular Table, 2 Leg, W1800	£572.00	£625.00
YDFT180	Half round Table, 2 Leg, W1600	£540.00	£590.00
YDFT184	Trapezoid Table, 2 leg, W1600	£550.00	£595.00





Alpine Meeting & Conference Tables

Smart and business-like, Alpine Conference tables are perfect for when you need a touch of class on a modest budget.

All our Alpine conference tables come with 25mm tops, 3mm lippings, a sturdy timber panel base or pole legs with a metal underframe. For an added touch of class why not have a pedestal column base?

A



A. Round tables - pole leg

- H720mm

		Group 1	Group 2
YCZM100	Pole Legs, Ø1000mm	£212.00	£230.00
YCZM120	Pole Legs, Ø1200mm	£265.00	£290.00

B



B. Round tables - panel leg

- H720mm

		Group 1	Group 2
YCOM101	Panel Leg, Ø1000mm	£235.00	£256.00
YCOM121	Panel Leg, Ø1200mm	£322.00	£369.00

C



C. Round tables - pedestal base

- H720mm

		Group 1	Group 2
YCOM080	Metal Base, Ø800mm	£610.00	£675.00
YCOM090	Metal Base, Ø900mm	£665.00	£725.00
YCOM100	Metal Base, Ø1000mm	£680.00	£740.00
YCOM120	Metal Base, Ø1200mm	£718.00	£789.00

Alpine Tables MFC Finishes

Group 1 Colours

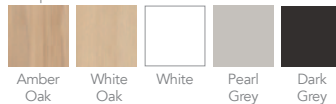
Amber
OakWhite
Oak

White

Pearl
GreyDark
Grey

Group 2 Colours

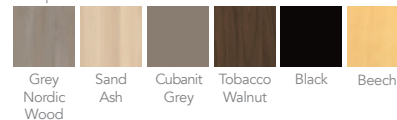
Grey
Nordic
WoodSand
AshCubanit
GreyTobacco
Walnut

Black

Beech

Wood & colour finishes may not be representative of actual colours - please ask for a sample

Alpine Meeting & Conference Tables

Smart and business like, Alpine Conference tables are perfect for when you need a touch of class on a modest budget.

All our Alpine conference tables come with 25mm tops, 3mm lippings, a sturdy timber panel base or pole legs with a metal underframe. For an added touch of class why not have a pedestal column base?



A. D-end tables

- Choice of pole or panel legs
- D1000 x H720mm

		Group 1	Group 2
YCZM201	Panel Leg, L2000	£406.00	£446.00
YCZM241	Panel Leg, L2400	£452.00	£497.00
YCZM200	Pole Legs, L2000 (Attached to Metal Underframe)	£475.00	£522.00
YCZM240	Pole Legs, L2400 (Attached to Metal Underframe)	£545.00	£599.00



A

B. Square-end tables

- Choice of pole or panel legs
- D1000 x H720mm

		Group 1	Group 2
YCZM203	Panel Leg, L2000	£432.00	£475.00
YCZM202	Pole Legs, L2000 (Attached to Metal Underframe)	£475.00	£522.00



B

C. Barrel top table

- Choice of pole or panel legs
- D1200 x H720mm

		Group 1	Group 2
YCZM243	Panel Leg, L2400	£509.00	£560.00
YCZM242	Pole Legs, L2400 (Attached to Metal Underframe)	£602.00	£662.00



C

The following table is for guidance only

Style	1200mm	1400mm	1600mm	1800mm	2000mm	2400mm
Square End	4 Seater	4 Seater	4 Seater	6 Seater	6-8 Seater	8-10 Seater
D End				6 Seater	6-8 Seater	8-10 Seater
Barrel Top			6 Seater	6 Seater	6-8 Seater	8-10 Seater
Circular	4/5 Seater	5-7 Seater	6-8 Seater			



Nova Conference Tables

- Modern, minimal and charming
- Nova conference tables have the huge benefit of no intermediate legs along the sides no matter how long you make the table. Freedom of movement with comfort, especially when you have to pack that extra person in
- Ultra modern technical design includes full optional cable management for IT supported conferences. Don't miss the matching Nova bench desking system on page 311
- Infinitely extendable using extensions YCNM144 and YCNM164

Alpine Tables MFC Finishes

Group 1 Colours

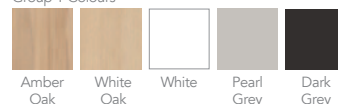

Group 2 Colours

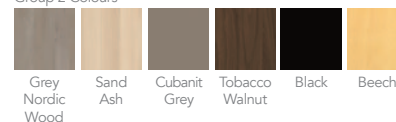

Frame Options

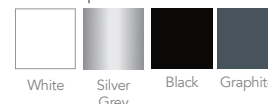

Wood & colour finishes may not be representative of actual colours - please ask for a sample

Stand alone tables

		Group 1	Group 2
YCNM080	L800 x W800 x H740mm	£335.00	£368.00
YCNM120	L1200 x W1200 x H740mm	£506.00	£552.00
YBNA180	L1800 x W1000 x H740mm	£515.00	£566.00
YBNA200	L2000 x W1000 x H740mm	£535.00	£588.00
YCNM100	Diameter 1000 x H740mm	£334.00	£367.00

Modular tables

		Group 1	Group 2
YCNM143	L1400 x W1640 x H740mm	£665.00	£730.00
YCNM163	L1600 x W1640 x H740mm	£703.00	£770.00
YCNM144	L1400 x W1640 x H740mm	£637.00	£699.00
YCNM164	L1600 x W1640 x H740mm	£672.00	£739.00



Accessories

Table Top Inserts

		Group 1	Group 2
YZNZ001	L1400 x W180mm	£66.00	£72.00
YZNZ002	L1600 x W180mm	£74.00	£82.00
YZNZ004	L1400 x W180mm	£66.00	£72.00
YZNZ005	L1600 x W180mm	£74.00	£82.00
YZNZ007	L1400 x W180mm	£66.00	£72.00
YZNZ008	L1600 x W180mm	£74.00	£82.00

Lift-up Cable Ports

YZNZ010	L320 x W130mm	£65.00
---------	---------------	--------

Shared Cable Trays for Bench Desking

YCTS110	L1100 x W180 x H110mm	£68.00
YCTS140	L1400 x W180 x H110mm	£80.00

Nova Bench Desking System

Beauty in simplicity. Nova combines clean and minimal aesthetics with great functionality. The Nova shared leg system keeps costs and assembly time down to a minimum. Recessed legs on all central locations make for clear, easy working. Three desktop options - scoop back for easy, low-cost cable management, tops with cutouts for large cable ports or straight tops for the ultimate in clean lines - all at the same price.

5 Year Warranty



N.B. The furniture shown here is just a small section of the Nova range - please ask for our full Range Guide.

Desk Top Colour Options

Group 1 Colours



Amber Oak

White Oak

White

Pearl Grey

Dark Grey

Group 2 Colours



Grey Nordic Wood

Sand Ash

Cubanit Grey

Tobacco Walnut

Black

Beech

Wood & colour finishes may not be representative of actual colours - please ask for a sample

Desk

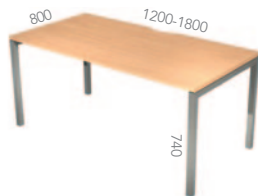

Desk with scoop back

	Group 1	Group 2
YDNA125 L1200mm	£375.00	£424.00
YDNA145 L1400mm	£399.00	£432.00
YDNA165 L1600mm	£435.00	£463.00
YDNA185 L1800mm	£466.00	£518.00

2 Desk Long Bench

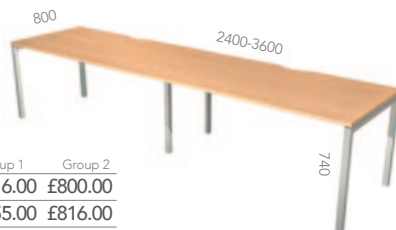

2 desk long bench with scoop backs

	Group 1	Group 2
YDNS248 L2400mm	£716.00	£800.00
YDNS288 L2800mm	£755.00	£816.00
YDNS328 L3200mm	£815.00	£878.00
YDNS368 L3600mm	£884.00	£984.00

Extension For Long Bench

Long desk extension with scoop back

	Group 1	Group 2
YDND128 L1200mm	£341.00	£376.00
YDND148 L1400mm	£356.00	£385.00
YDND168 L1600mm	£380.00	£415.00
YDND188 L1800mm	£418.00	£466.00

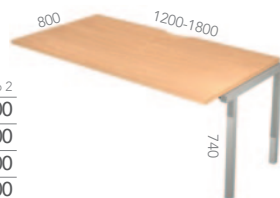

All desks also available in 700mm depth. Ideal for IT suites

2 Desk Square Bench

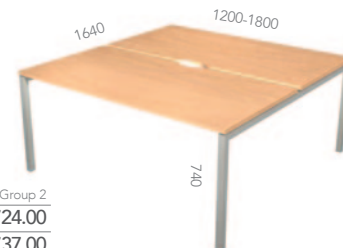

2 desk square bench with scoop backs

	Group 1	Group 2
YDNS126 L1200mm	£654.00	£724.00
YDNS146 L1400mm	£678.00	£737.00
YDNS166 L1600mm	£732.00	£802.00
YDNS186 L1800mm	£810.00	£904.00

4 Desk Square Bench



4 desk square bench with scoop backs

	Group 1	Group 2
YDNS247 L2400mm	£1209.00	£1417.00
YDNS287 L2800mm	£1257.00	£1448.00
YDNS327 L3200mm	£1421.00	£1570.00
YDNS367 L3600mm	£1549.00	£1780.00

Extension For Square Bench

Extension for square bench with scoop back

	Group 1	Group 2
YDND127 L1200mm	£555.00	£694.00
YDND147 L1400mm	£579.00	£712.00
YDND167 L1600mm	£689.00	£769.00
YDND187 L1800mm	£739.00	£877.00





Nova Wood Bench Desking

The Nova Wood bench desking can complement many learning or office environments. The Nova Wood adds a delicate sense of luxury to the office and brings you closer to nature and a home atmosphere! Ideal in open plan offices where you can arrange different areas for individual or collaborative work, meetings or leisure activities. Every table is unique due to solid ash wood legs:

- Wood texture and wide growth rings create a distinctive pattern
- Stained and lacquered wood reveals the pattern even more
- Natural wood tends to change its colour over time
- 25mm MFC top
- 740mm High
- Straight back and cable port cut-out options also available

Desk with single scoop back

	L x W x Hmm	Group 1	Group 2
Y702700	1200 x 700 x 740	£799.00	£838.00
Y702701	1400 x 700 x 740	£815.00	£848.00
Y702703	1600 x 700 x 740	£840.00	£878.00
Y702704	1200 x 800 x 740	£844.00	£878.00
Y702705	1400 x 800 x 740	£858.00	£889.00
Y702706	1600 x 800 x 740	£882.00	£921.00
Y702707	1800 x 800 x 740	£924.00	£977.00

Back-to-back 2 desk bench scoop back

	L x W x Hmm	Group 1	Group 2
Y702715	1200 x 1440 x 740	£1288.00	£1359.00
Y702716	1400 x 1440 x 740	£1319.00	£1380.00
Y702717	1600 x 1440 x 740	£1374.00	£1446.00
Y702718	1200 x 1640 x 740	£1379.00	£1455.00
Y702719	1400 x 1640 x 740	£1408.00	£1475.00
Y702720	1600 x 1640 x 740	£1462.00	£1536.00
Y702721	1800 x 1640 x 740	£1547.00	£1653.00

Back-to-back 2 desk bench add-on scoop back

	L x W x Hmm	Group 1	Group 2
Y702730	1200 x 1440 x 740	£778.00	£852.00
Y702731	1400 x 1440 x 740	£809.00	£872.00
Y702732	1600 x 1440 x 740	£859.00	£935.00
Y702733	1200 x 1640 x 740	£806.00	£878.00
Y702734	1400 x 1640 x 740	£832.00	£895.00
Y702735	1600 x 1640 x 740	£889.00	£961.00
Y702736	1800 x 1640 x 740	£972.00	£1073.00

Desk Top Colour Options

Wood & colour finishes may not be representative of actual colours - please ask for a sample

Group 1 Colours



Amber Oak White Oak White Pearl Grey Dark Grey

Group 2 Colours



Grey Nordic Wood Sand Ash Cubanit Grey Tobacco Walnut Black

New Product



Page Link - see page

For Nova Wood High Tables

350



Alpine Pedestals And Desk Height Storage

- Pedestals & desk height storage to complement the Alpine ranges
- A huge choice of pedestals to suit every requirement and situation - don't forget the purpose made pen trays
- Desk height quadrant bookcases add that finishing touch and can double as a meeting point
- All desk height pedestals have height adjustable feet

Desk Top Colour Options

Group 1 Colours

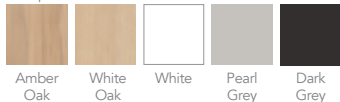

Group 2 Colours

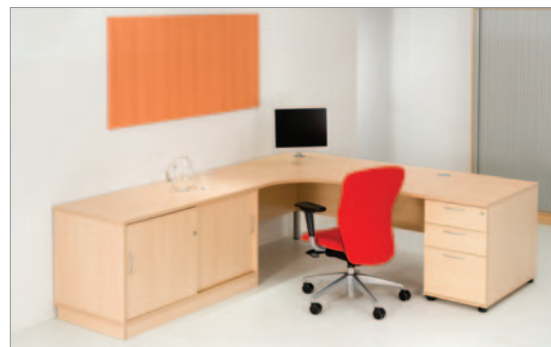
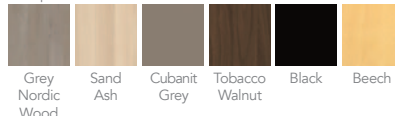

Wood & colour finishes may not be representative of actual colours - please ask for a sample

CONTRACT FIXED PEDESTALS



White finish wooden drawer sides.
Metal file frame, central locking
W415 x D500 x H446mm

		Group 1	Group 2
YPS525	2 Drawer	£246.00	£270.00
YPS532	3 Drawer	£246.00	£270.00

CONTRACT DESK HEIGHT PEDESTALS



White finish wooden drawer sides. Metal file frame. Central locking
W415 x H720mm

			Group 1	Group 2
YPS637	3 Drawer D600		£322.00	£355.00
YPS642	4 Drawer D600		£339.00	£373.00
YPS837	3 Drawer D800		£369.00	£406.00

CONTRACT SMALL MOBILE PEDESTALS



White finish wooden drawer sides.
Metal file frame, central locking,
mobile castors
W415 x D500 x H510mm

		Group 1	Group 2
YPSR525	2 Drawer	£238.00	£262.00
YPSR532	3 Drawer	£248.00	£273.00

HEAVY DUTY DESK HEIGHT PEDESTALS



Metal drawer sides and solid drawer bottoms. Metal file frame, central locking, anti-tilt mechanism
W430 x H720mm

			Group 1	Group 2
YPU5635	3 Drawer D600		£429.00	£472.00
YPU5642	4 Drawer D600		£445.00	£490.00
YPU5835	3 Drawer D800		£492.00	£545.00

STANDARD CONTRACT MOBILE PEDESTALS



White finish wooden drawer sides.
Metal file frame, central locking,
mobile castors
W415 x D500mm

		Group 1	Group 2
YPSR535	3 Drw, H638	£272.00	£302.00
YPSR541	4 Drw, H638	£294.00	£323.00

PEN TRAYS



Organise paper, envelopes and forms in pedestal drawers.

ZZZ004	For PSR & PSS, D235mm	£22.00
ZZZ006	For PUR & PUS, D250mm	£29.00

Page Link - see pages

For steel pedestals

370



5 Year
Warranty

Alpine Storage

SHALLOW BOOKCASE



W800 x D400 x H720mm
Shallow Open Front Unit with 1 Shelf

	Group 1	Group 2
YPXA420	£175.00	£193.00

SLIDING DOOR CUPBOARD



W1200 x D600 x H720mm
Lockable Sliding Doors with Internal Shelf

	Group 1	Group 2
YPLX620	£445.00	£490.00

DEEP CUPBOARD



W800 x D600 x H720mm
Cupboard with Locking Doors & 1 Shelf

	Group 1	Group 2
YPXD620	£315.00	£347.00

FILING CABINETS



H720mm



H1020mm



H1320mm

W500mm x D600

		Group 1	Group 2
YPEX627	2 Drawer, H720mm (Desk Height)	£340.00	£375.00
YPEX637	3 Drawer, H1020mm	£465.00	£512.00
YPEX647	4 Drawer, H1320mm	£585.00	£645.00

DEEP TAMBOUR CUPBOARDS 1000MM WIDE, 475MM DEEP

- Supplied empty – see below for accessories.
- For plinth options see page 316. Plinths have to be ordered separately.

We recommend all units over
1200mm tall are fitted to the
wall for safety purposes. Please
contact us for a quotation



H834mm

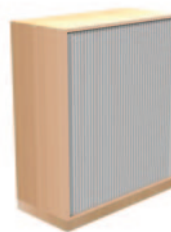

H1200mm

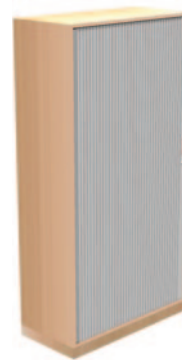

H1954mm

		Group 1	Group 2		Group 1	Group 2		Group 1	Group 2		
Cupboard	YU2T101	£522.00	£574.00	Cupboard	YU3T101	£629.00	£690.00	Cupboard	YU5T101	£895.00	£978.00

DEEP TAMBOUR ACCESSORIES

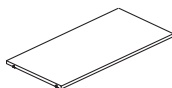

YU0Z001

	Group 1	Group 2
Shelf	£36.00	£39.00

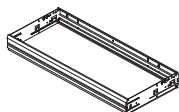

YU0Z004

Pull out Filing Cradle, A4
or Foolsap Filing £205.00

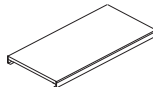

YU0Z003

Lateral Filing Shelf, A4
or Foolsap Filing £109.00

Page Link - see pages

For Steel
Storage

362-370



Alpine X-Range

- A choice of over 60 cupboard and bookcase combinations to match all the Alpine ranges
- All storage units have 19mm carcasses, 25mm tops to complement desking, height adjustable levellers and finished backs, i.e. may be used as room dividers. Includes height adjustable shelves
- All cupboards include locks
- For plinth options see page 316. Plinths have to be ordered separately.
- X-RANGE STORAGE is 425mm deep except where otherwise indicated

11 MFC finishes available – see page 317

600mm WIDE, 5 LEVEL

H1954mm



YX5N061
Bookcase

Group 1
£320.00
Group 2
£352.00

YX5C061
Cupboard
RH Handle

Group 1
£438.00
Group 2
£482.00

YX5C062
Cupboard
LH Handle

Group 1
£438.00
Group 2
£482.00

YX5H061
Cupboard
RH Handle

Group 1
£382.00
Group 2
£420.00

YX5H062
Cupboard
LH Handle

Group 1
£382.00
Group 2
£420.00

600mm WIDE, 6 LEVEL

H2320mm



YX6N061
Bookcase

Group 1
£395.00
Group 2
£435.00

YX6C061
Cupboard
RH Handle

Group 1
£535.00
Group 2
£588.00

YX6C062
Cupboard
LH Handle

Group 1
£535.00
Group 2
£588.00

800mm WIDE, 2 LEVEL

H834mm



YX2N081
Bookcase
Group 1
£189.00
Group 2
£208.00

YX2C081
Cupboard
Group 1
£318.00
Group 2
£349.00

YX2F081
Sidefiler
Group 1
£809.00
Group 2
£888.00

A4 Files
Only

800mm WIDE, 4 LEVEL

H1588mm



YX4N081
Bookcase

Group 1
£310.00
Group 2
£341.00

YX4H081
Cupboard

Group 1
£419.00
Group 2
£459.00

YX4C081
Cupboard

Group 1
£499.00
Group 2
£549.00

800mm WIDE, 3 LEVEL

H1211mm



YX3N081
Bookcase

Group 1
£252.00
Group 2
£277.00

YX3C081*
Cupboard

Group 1
£385.00
Group 2
£424.00

We recommend all units over 1200mm tall are fitted to the wall for safety purposes. Please contact us for a quotation



5 Year
Warranty

Plinths have to be ordered separately. See bottom of page for options.

800mm WIDE, 5 LEVEL H1954mm



YX5N081
Bookcase

Group 1	Group 2
£359.00	£394.00



YX5H081
Cupboard

Group 1	Group 2
£469.00	£515.00



YX5C081
Cupboard

Group 1	Group 2
£599.00	£658.00



YX5F081
Bookcase & Sidefile,
A4 Files Only

Group 1	Group 2
£979.00	£1029.00



YX5G081
Cupboard with Glass Doors

Group 1	Group 2
£765.00	£835.00

We recommend all units over 1200mm tall are fitted to the wall for safety purposes. Please contact us for a quotation

800mm WIDE, 6 LEVEL (Strongly recommend these units are fixed back to wall)

H2320mm



YX6N081
Bookcase

Group 1	Group 2
£427.00	£469.00



YX6C081
Cupboard

Group 1	Group 2
£654.00	£719.00



YX6H081
Cupboard

Group 1	Group 2
£499.00	£548.00

WALL MOUNTED UNIT, 1 SHELF

H370mm



YX1N081
Wall Unit

Group 1	Group 2
£119.00	£130.00



YX1C081
Wall Unit with Doors

Group 1	Group 2
£168.00	£184.00

1000mm WIDE, 2 LEVEL

H834mm



YX2N101 Bookcase

Group 1	Group 2
£229.00	£252.00



YX2C101 Cupboard

Group 1	Group 2
£375.00	£410.00



YX2F101 Sidefile

Group 1	Group 2
£917.00	£1008.00

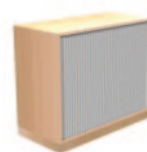

YX2T101 Tambour Cupboard

Group 1	Group 2
£515.00	£566.00



YX2S101 Cupboard

Group 1	Group 2
£399.00	£439.00

BASE OPTIONS



Wooden Plinth Base

With hidden adjustable feet for levelling purposes. This option is the standard base on all units unless otherwise specified.

	Size mm	
Y701910	800	£32.00
Y701911	1000	£39.00
Y701912	1200	£42.00
Y701913	1600	£48.00



Nova Feet

Square, tubular metal feet, adjustable for levelling purposes. Available in White (E), Silver (M), and Dark Grey (T1).

	Size mm	
Y701914	800-1000	£32.00
Y701915	1200-1600	£32.00



Plastic Feet

Black plastic feet, adjustable feet for levelling purposes. NB This foot option is smaller than the others and therefore lowers the overall unit height by 57mm.

Y701916	set	£15.00
---------	-----	--------

5 Year Warranty



For plinth options see page 316. Wooden plinth will be supplied by default.

1000mm WIDE, 3 LEVEL

H1200mm



YX3S101 Sliding Door Cupboard
Group 1 Group 2
£475.00 £522.00



YX3C101 Cupboard
Group 1 Group 2
£455.00 £510.00



YX3T101 Tambour Cupboard
Group 1 Group 2
£729.00 £802.00

1200mm WIDE, 2/3 LEVEL



YX2S121 Cupboard
Group 1 Group 2
£379.00 £417.00



YX3S121 Sliding Door Cupboard
Group 1 Group 2
£452.00 £497.00



YX2N121 Bookcase Top Unit
Group 1 Group 2
£259.00 £285.00

1000mm WIDE, 5 LEVEL H1954mm



YX5N101 Bookcase
Group 1 Group 2
£392.00 £432.00



YX5C101 Cupboard
Group 1 Group 2
£595.00 £654.00

1200mm WIDE, 5 LEVEL H1954mm



YX5N121 Bookcase
Group 1 Group 2
£489.00 £538.00



YX5C121 Cupboard
Group 1 Group 2
£679.00 £746.00



YX5S121 Sliding Door Cupboard
Group 1 Group 2
£678.00 £745.00

1000mm WIDE, 6 LEVEL H2320mm



YX6N101 Bookcase
Group 1 Group 2
£485.00 £534.00



YX6C101 Cupboard
Group 1 Group 2
£739.00 £812.00

1200mm WIDE, 6 LEVEL H2320mm



YX6N121 Bookcase
Group 1 Group 2
£549.00 £604.00



YX6C121 Cupboard
Group 1 Group 2
£779.00 £856.00

We recommend all units over 1200mm tall are fitted to the wall for safety purposes. Please contact us for a quotation



Wilmington Cantilever Range

An affordable range of cantilever desking in a vast range of sizes and colours.

Other sizes available that are not shown – please enquire.

- 25mm deep top
- Supplied flat packed – please ask if assembly is required
- Mix & Match finishes can be provided with a £20 upcharge per item

Page Link - see page

For
Pedestals

336



A. Rectangular desk 800mm deep

	W x D x H(mm)	Band 1	Band 2
Y705400	800 x 800 x 740	£275.00	£308.00
Y705401	1000 x 800 x 740	£289.00	£319.00
Y705402	1200 x 800 x 740	£299.00	£332.00
Y705403	1400 x 800 x 740	£315.00	£349.00
Y705404	1600 x 800 x 740	£329.00	£369.00
Y705405	1800 x 800 x 740	£345.00	£389.00
Y705406	2000 x 800 x 740	£359.00	£405.00

B. Rectangular desk 600mm deep

	W x D x H(mm)	Band 1	Band 2
Y705410	800 x 600 x 740	£259.00	£289.00
Y705411	1000 x 600 x 740	£272.00	£305.00
Y705412	1200 x 600 x 740	£289.00	£319.00
Y705413	1400 x 600 x 740	£298.00	£332.00
Y705414	1600 x 600 x 740	£312.00	£349.00
Y705415	1800 x 600 x 740	£329.00	£364.00
Y705416	2000 x 600 x 740	£342.00	£383.00

C. Rectangular D ended desk 800mm deep

- Please specify hand - RH shown

	W x D x H(mm)	Band 1	Band 2
Y705420	2000 x 800 x 740	£487.00	£531.00
Y705421	2200 x 800 x 740	£512.00	£559.00

D. Angular desk 800mm ends

- Please specify hand - RH shown

	W x D x H(mm)	Band 1	Band 2
Y705425	2000 x 1134 x 740	£547.00	£595.00
Y705426	2200 x 1134 x 740	£572.00	£619.00

A



B



C



D



Top Finishes Band 1

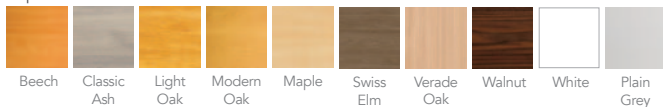

Top Finishes Band 2

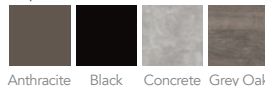

Standard Metalwork Finishes



Silver
supplied
if not
specified



A. Crescent desk 800 x 600mm ends

- Please specify hand - RH shown

	W x D x H(mm)	Band 1	Band 2
Y705430	1200 x 1200 x 740	£352.00	£405.00
Y705431	1400 x 1200 x 740	£362.00	£421.00
Y705432	1600 x 1200 x 740	£385.00	£447.00
Y705433	1800 x 1200 x 740	£408.00	£466.00
Y705434	2000 x 1200 x 740	£440.00	£499.00

B. Crescent desk 600 x 600mm ends

- Please specify hand - RH shown

	W x D x H(mm)	Band 1	Band 2
Y705440	1200 x 1200 x 740	£333.00	£389.00
Y705441	1400 x 1200 x 740	£351.00	£404.00
Y705442	1600 x 1200 x 740	£379.00	£432.00
Y705443	1800 x 1200 x 740	£395.00	£460.00
Y705444	2000 x 1200 x 740	£422.00	£489.00

C. Compact wave desk 800 x 600mm ends

- Please specify hand - RH shown

	W x D x H(mm)	Band 1	Band 2
Y705450	1000 x 800 x 740	£299.00	£333.00
Y705451	1200 x 800 x 740	£312.00	£347.00
Y705452	1400 x 800 x 740	£325.00	£361.00
Y705453	1600 x 800 x 740	£339.00	£379.00
Y705454	1800 x 800 x 740	£358.00	£394.00

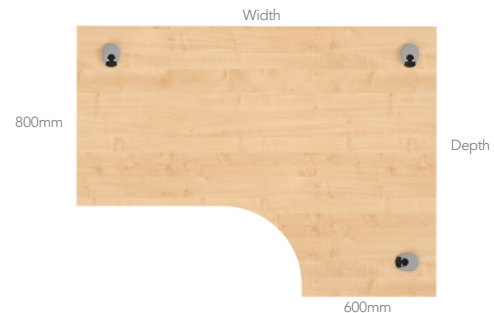

A



B



C



D



Page Link - see page

For
Pedestals

336



Top Finishes Band 1

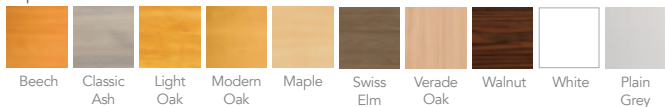

Top Finishes Band 2

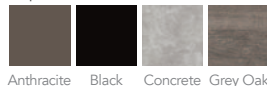

Standard Metalwork Finishes

Silver
supplied
if not
specifiedWilmington Executive Wire Managed
Cantilever Range

The great way to keep wires neatly tucked away. The Wilmington wire managed leg frame is a factory fitted option available in matching or contrasting colours.

- Other sizes available that are not shown – please enquire.
- 25mm deep tops
- Supplied flat packed – please ask if assembly is required
- Mix & Match finishes can be provided with a £20 upcharge per item

A. Rectangular desk 800mm deep

	W x D x H(mm)	Band 1	Band 2
Y705460	800 x 800 x 740	£362.00	£393.00
Y705461	1000 x 800 x 740	£372.00	£405.00
Y705462	1200 x 800 x 740	£387.00	£420.00
Y705463	1400 x 800 x 740	£399.00	£435.00
Y705464	1600 x 800 x 740	£414.00	£454.00
Y705465	1800 x 800 x 740	£431.00	£470.00
Y705466	2000 x 800 x 740	£447.00	£491.00

B. Rectangular desk 600mm deep

	W x D x H(mm)	Band 1	Band 2
Y705470	800 x 600 x 740	£347.00	£375.00
Y705471	1000 x 600 x 740	£359.00	£389.00
Y705472	1200 x 600 x 740	£370.00	£404.00
Y705473	1400 x 600 x 740	£385.00	£418.00
Y705474	1600 x 600 x 740	£398.00	£435.00
Y705475	1800 x 600 x 740	£413.00	£449.00
Y705476	2000 x 600 x 740	£430.00	£470.00

C. Rectangular D ended desk 800mm deep

- Please specify hand - RH shown

	W x D x H(mm)	Band 1	Band 2
Y705480	2000 x 800 x 740	£577.00	£622.00
Y705481	2200 x 800 x 740	£599.00	£651.00

D. Angular desk 800mm ends

- Please specify hand - RH shown

	W x D x H(mm)	Band 1	Band 2
Y705485	2000 x 1134 x 740	£631.00	£676.00
Y705486	2200 x 1134 x 740	£662.00	£709.00



A. Crescent desk 800 x 600mm ends

- Please specify hand - RH shown

	W x D x H(mm)	Band 1	Band 2
Y705490	1200 x 1200 x 740	£434.00	£492.00
Y705491	1400 x 1200 x 740	£449.00	£509.00
Y705492	1600 x 1200 x 740	£469.00	£538.00
Y705493	1800 x 1200 x 740	£489.00	£556.00
Y705494	2000 x 1200 x 740	£521.00	£595.00

B. Crescent desk 600 x 600mm ends

- Please specify hand - RH shown

	W x D x H(mm)	Band 1	Band 2
Y705500	1200 x 1200 x 740	£420.00	£478.00
Y705501	1400 x 1200 x 740	£435.00	£494.00
Y705502	1600 x 1200 x 740	£454.00	£522.00
Y705503	1800 x 1200 x 740	£472.00	£541.00
Y705504	2000 x 1200 x 740	£504.00	£577.00

C. Compact wave desk 800 x 600mm ends

- Please specify hand - RH shown

	W x D x H(mm)	Band 1	Band 2
Y705510	1000 x 800 x 740	£390.00	£424.00
Y705511	1200 x 800 x 740	£400.00	£438.00
Y705512	1400 x 800 x 740	£413.00	£451.00
Y705513	1600 x 800 x 740	£427.00	£469.00
Y705514	1800 x 800 x 740	£441.00	£485.00

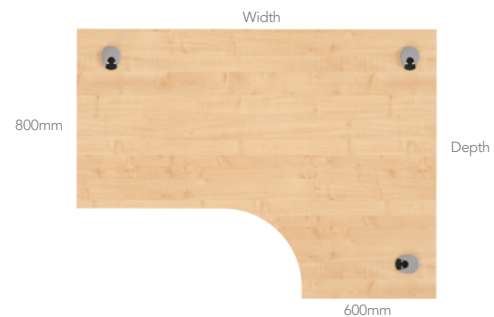

A



B



C



D



Wilmington Panel Leg Range

A quality panel leg range of desking in a good range of sizes and colours.

The 25mm panel ends provide an extremely strong desk whilst giving a little extra privacy.

Other sizes available that are not shown – please enquire.

- 25mm deep top
- Supplied flat packed – please ask if assembly is required
- Mix & Match finishes can be provided with a £20 upcharge per item

A. Rectangular desk 800mm deep

	W x D x H(mm)	Band 1	Band 2
Y705520	800 x 800 x 740	£239.00	£285.00
Y705521	1000 x 800 x 740	£259.00	£295.00
Y705522	1200 x 800 x 740	£262.00	£309.00
Y705523	1400 x 800 x 740	£275.00	£318.00
Y705524	1600 x 800 x 740	£289.00	£335.00
Y705525	1800 x 800 x 740	£299.00	£349.00
Y705526	2000 x 800 x 740	£302.00	£369.00

B. Rectangular desk 600mm deep

	W x D x H(mm)	Band 1	Band 2
Y705530	800 x 600 x 740	£228.00	£259.00
Y705531	1000 x 600 x 740	£239.00	£279.00
Y705532	1200 x 600 x 740	£255.00	£292.00
Y705533	1400 x 600 x 740	£265.00	£309.00
Y705534	1600 x 600 x 740	£278.00	£328.00
Y705535	1800 x 600 x 740	£289.00	£335.00
Y705536	2000 x 600 x 740	£299.00	£345.00

C. Rectangular D ended desk 800mm deep

- Please specify hand - RH shown

	W x D x H(mm)	Band 1	Band 2
Y705540	2000 x 800 x 740	£435.00	£489.00
Y705541	2200 x 800 x 740	£455.00	£529.00

D. Angular desk 800mm ends

- Please specify hand - RH shown

	W x D x H(mm)	Band 1	Band 2
Y705545	2000 x 1134 x 740	£489.00	£545.00
Y705546	2200 x 1134 x 740	£535.00	£565.00

Page Link - see page

For Pedestals

336



Top Finishes Band 1

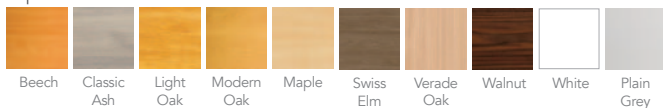

Top Finishes Band 2

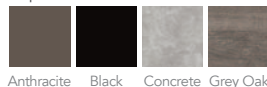



A. Crescent desk 800 x 600mm ends

- Please specify hand - RH shown

	W x D x H(mm)	Band 1	Band 2
Y705550	1200 x 1200 x 740	£308.00	£369.00
Y705551	1400 x 1200 x 740	£318.00	£389.00
Y705552	1600 x 1200 x 740	£335.00	£409.00
Y705553	1800 x 1200 x 740	£349.00	£425.00
Y705554	2000 x 1200 x 740	£379.00	£465.00

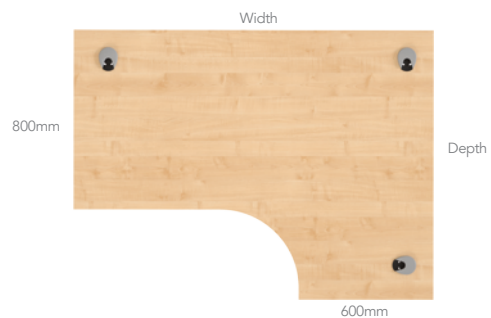

B. Crescent desk 600 x 600mm ends

- Please specify hand - RH shown

	W x D x H(mm)	Band 1	Band 2
Y705560	1200 x 1200 x 740	£299.00	£365.00
Y705561	1400 x 1200 x 740	£309.00	£385.00
Y705562	1600 x 1200 x 740	£339.00	£405.00
Y705563	1800 x 1200 x 740	£349.00	£425.00
Y705564	2000 x 1200 x 740	£379.00	£445.00



C. Compact wave desk 800 x 600mm ends

- Please specify hand - RH shown

	W x D x H(mm)	Band 1	Band 2
Y705570	1000 x 800 x 740	£265.00	£305.00
Y705571	1200 x 800 x 740	£285.00	£330.00
Y705572	1400 x 800 x 740	£295.00	£345.00
Y705573	1600 x 800 x 740	£315.00	£360.00
Y705574	1800 x 800 x 740	£325.00	£380.00



A



B



C



D

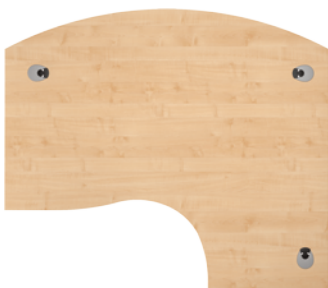

Page Link - see page

For
Pedestals

336



Top Finishes Band 1

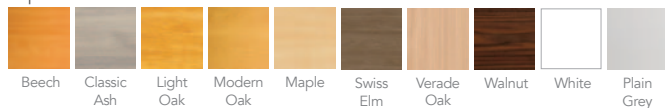

Top Finishes Band 2

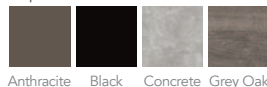

Wilmington Executive Panel Leg Range

The Wilmington Executive desking has a stylish panel end leg and curved modesty panel.

Distinctly more refined with an elegant curve to provide an sophisticated look for your office.

Other sizes available that are not shown – please enquire.

- 25mm deep top
- Supplied flat packed – please ask if assembly is required
- Mix & Match finishes can be provided with a £20 upcharge per item

A. Rectangular desk 800mm deep

	W x D x H(mm)	Band 1	Band 2
Y705580	800 x 800 x 740	£325.00	£370.00
Y705581	1000 x 800 x 740	£335.00	£380.00
Y705582	1200 x 800 x 740	£350.00	£395.00
Y705583	1400 x 800 x 740	£360.00	£410.00
Y705584	1600 x 800 x 740	£375.00	£430.00
Y705585	1800 x 800 x 740	£390.00	£440.00
Y705586	2000 x 800 x 740	£400.00	£460.00

B. Rectangular desk 600mm deep

	W x D x H(mm)	Band 1	Band 2
Y705590	800 x 600 x 740	£315.00	£355.00
Y705591	1000 x 600 x 740	£325.00	£365.00
Y705592	1200 x 600 x 740	£335.00	£380.00
Y705593	1400 x 600 x 740	£350.00	£395.00
Y705594	1600 x 600 x 740	£365.00	£410.00
Y705595	1800 x 600 x 740	£375.00	£425.00
Y705596	2000 x 600 x 740	£390.00	£440.00

C. Rectangular D ended desk 800mm deep

- Please specify hand - RH shown

	W x D x H(mm)	Band 1	Band 2
Y705601	2000 x 800 x 740	£525.00	£580.00
Y705602	2200 x 800 x 740	£550.00	£610.00

D. Bow fronted S-shaped desk

- Please specify hand - RH shown

	W x D x H(mm)	Band 1	Band 2
Y705605	1600 x 1400 x 740	£540.00	£635.00
Y705606	1800 x 1400 x 740	£590.00	£675.00
Y705607	2000 x 1400 x 740	£635.00	£730.00



A. Crescent desk 800 x 600mm ends

• Please specify hand - RH shown

	W x D x H(mm)	Band 1	Band 2
Y705610	1200 x 1200 x 740	£405.00	£475.00
Y705611	1400 x 1200 x 740	£420.00	£495.00
Y705612	1600 x 1200 x 740	£440.00	£520.00
Y705613	1800 x 1200 x 740	£450.00	£535.00
Y705614	2000 x 1200 x 740	£490.00	£570.00

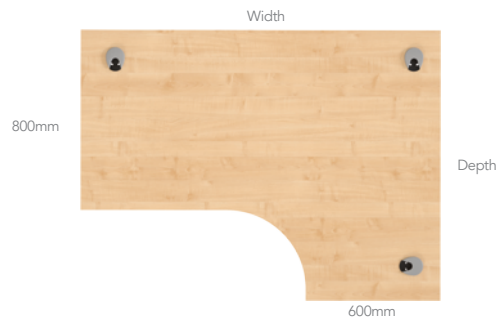

A

B. Crescent desk 600 x 600mm ends

• Please specify hand - RH shown

	W x D x H(mm)	Band 1	Band 2
Y705620	1200 x 1200 x 740	£395.00	£465.00
Y705621	1400 x 1200 x 740	£410.00	£475.00
Y705622	1600 x 1200 x 740	£425.00	£505.00
Y705623	1800 x 1200 x 740	£445.00	£520.00
Y705624	2000 x 1200 x 740	£470.00	£555.00

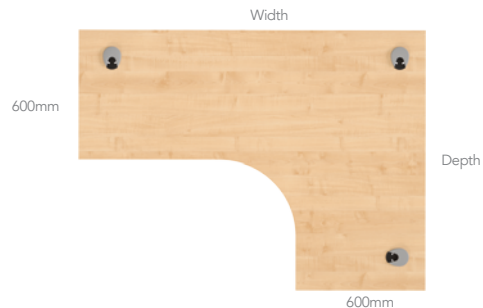

B

C. Compact Wave Desk 800 x 600mm End

• Please specify hand - RH shown

	W x D x H(mm)	Band 1	Band 2
Y705627	1400 x 800 x 740	£375.00	£425.00
Y705628	1600 x 800 x 740	£385.00	£440.00
Y705629	1800 x 800 x 740	£399.00	£455.00



C



A



B



C



D



Wilmington Bench Desking

Bench desking has evolved over time and customers often 'just want a desk' without the bells and whistles. A sturdy but effective frame and a great choice of colour tops.

- 25mm Tops
- Central 2-stage scallops for cable management
- FIRA Rated to BS EN527 Part 2

A. Single bench starter 800mm deep

	W x D x H(mm)	Band 1	Band 2
Y705634	1000 x 800 x 740	£279.00	£295.00
Y705635	1200 x 800 x 740	£295.00	£315.00
Y705636	1400 x 800 x 740	£320.00	£339.00
Y705637	1600 x 800 x 740	£339.00	£360.00
Y705638	1800 x 800 x 740	£355.00	£379.00

B. Single bench add-on 800mm deep

	W x D x H(mm)	Band 1	Band 2
Y705640	1000 x 800 x 740	£255.00	£269.00
Y705641	1200 x 800 x 740	£265.00	£285.00
Y705642	1400 x 800 x 740	£289.00	£309.00
Y705643	1600 x 800 x 740	£305.00	£325.00
Y705644	1800 x 800 x 740	£319.00	£345.00

C. Double bench starter 800mm deep

	W x D x H(mm)	Band 1	Band 2
Y705648	1000 x 800 x 740	£499.00	£535.00
Y705649	1200 x 800 x 740	£525.00	£559.00
Y705650	1400 x 800 x 740	£549.00	£585.00
Y705651	1600 x 800 x 740	£559.00	£600.00
Y705652	1800 x 800 x 740	£580.00	£625.00

D. Double bench add-on 800mm deep

	W x D x H(mm)	Band 1	Band 2
Y705655	1000 x 800 x 740	£449.00	£485.00
Y705656	1200 x 800 x 740	£470.00	£505.00
Y705657	1400 x 800 x 740	£490.00	£529.00
Y705658	1600 x 800 x 740	£500.00	£545.00
Y705659	1800 x 800 x 740	£525.00	£565.00

Top Finishes Band 1

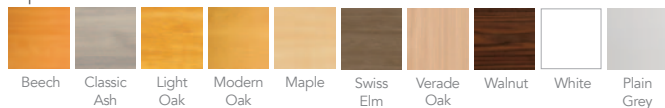

Top Finishes Band 2



Standard Metalwork Finishes



Silver supplied if not specified

Wilmington Bench Desking

A. Single bench starter 600mm deep

	W x D x H(mm)	Band 1	Band 2
Y705665	1000 x 600 x 740	£251.00	£265.00
Y705666	1200 x 600 x 740	£279.00	£293.00
Y705667	1400 x 600 x 740	£315.00	£329.00
Y705668	1600 x 600 x 740	£330.00	£348.00
Y705669	1800 x 600 x 740	£349.00	£366.00

B. Single bench add-on 600mm deep

	W x D x H(mm)	Band 1	Band 2
Y705674	1000 x 600 x 740	£225.00	£240.00
Y705675	1200 x 600 x 740	£251.00	£265.00
Y705676	1400 x 600 x 740	£283.00	£297.00
Y705677	1600 x 600 x 740	£296.00	£316.00
Y705678	1800 x 600 x 740	£314.00	£332.00

C. Double bench starter 600mm deep

	W x D x H(mm)	Band 1	Band 2
Y705682	1000 x 600 x 740	£441.00	£471.00
Y705683	1200 x 600 x 740	£490.00	£552.00
Y705684	1400 x 600 x 740	£540.00	£572.00
Y705685	1600 x 600 x 740	£549.00	£586.00
Y705686	1800 x 600 x 740	£575.00	£610.00

D. Double bench add-on 600mm deep

	W x D x H(mm)	Band 1	Band 2
Y705690	1000 x 600 x 740	£398.00	£428.00
Y705691	1200 x 600 x 740	£440.00	£472.00
Y705692	1400 x 600 x 740	£485.00	£519.00
Y705693	1600 x 600 x 740	£494.00	£531.00
Y705694	1800 x 600 x 740	£516.00	£552.00

E. Wooden modesty panel

	Size to Fit mm	
Y705697	1000	£131.00
Y705698	1200	£137.00
Y705699	1400	£144.00
Y705700	1600	£150.00
Y705701	1800	£156.00

F. Steel cable tray

	Size to Fit mm	
Y705705	1000	£44.00
Y705706	1200	£47.00
Y705707	1400	£50.00
Y705708	1600	£55.00
Y705709	1800	£61.00

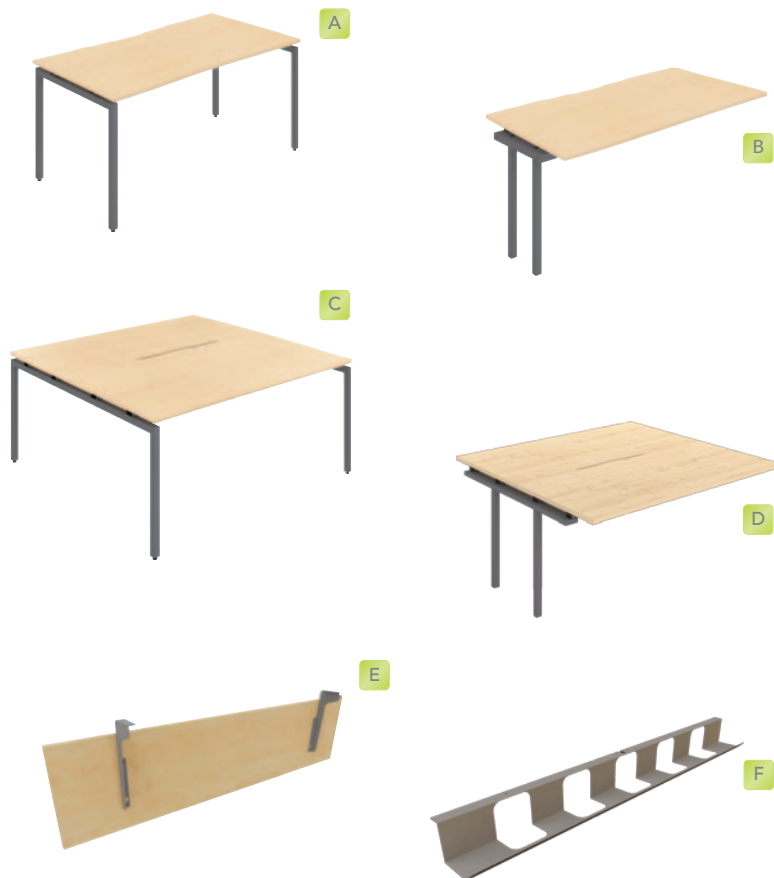



Wilmington Pole Leg Tables

A range of multipurpose tables with fully welded frames and 40mm round tubular legs. Finished in 25mm MFC with 2mm ABS edging.

- Frames are supplied with adjustable feet

A. Multipurpose square tables

	W x D x H(mm)	Band 1	Band 2
Y705712	800 x 800 x 740	£219.00	£225.00

B. Multipurpose rectangular tables

	W x D x H(mm)	Band 1	Band 2
Y705715	800 x 600 x 740	£195.00	£219.00
Y705716	1000 x 600 x 740	£237.00	£249.00
Y705717	1200 x 600 x 740	£244.00	£259.00
Y705718	1400 x 600 x 740	£254.00	£269.00
Y705719	1600 x 600 x 740	£260.00	£279.00
Y705720	1800 x 600 x 740	£286.00	£295.00
Y705721	1000 x 800 x 740	£245.00	£259.00
Y705722	1200 x 800 x 740	£254.00	£269.00
Y705723	1400 x 800 x 740	£261.00	£279.00
Y705724	1600 x 800 x 740	£268.00	£289.00
Y705725	1800 x 800 x 740	£295.00	£309.00

C. Multipurpose trapezoidal tables

	W x D x H(mm)	Band 1	Band 2
Y705729	1200 x 693 x 740	£328.00	£339.00
Y705730	1600 x 693 x 740	£359.00	£379.00

- Internal angles 60° / 120°.

D. Multipurpose semi-circular tables

	W x D x H(mm)	Band 1	Band 2
Y705735	1200 x 600 x 740	£328.00	£339.00
Y705736	1600 x 800 x 740	£359.00	£379.00

E. Multipurpose circular tables

	Diameter x H(mm)	Band 1	Band 2
Y705738	800 x 740	£345.00	£365.00
Y705739	1000 x 740	£375.00	£395.00
Y705740	1200 x 740	£425.00	£445.00

A



B



C



D



E



For larger quantities
please phone for pricing

Top Finishes Band 1

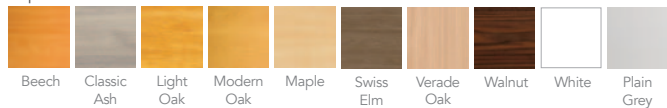

Top Finishes Band 2

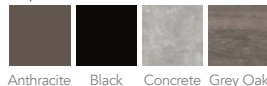

Standard Metalwork Finishes



Silver
supplied
if not
specified

Wilmington Tilt Top Tables

A. Rectangular tilt top tables 800mm deep

- Tip top tables feature a tilting top from a horizontal to a vertical position using a single lever bar with integrated locking action
- Fitted with 2 lockable & 2 non-lockable castors

	W x D x H(mm)	Band 1	Band 2
Y705745	800 x 800 x 740	£458.00	£474.00
Y705746	1000 x 800 x 740	£472.00	£490.00
Y705747	1200 x 800 x 740	£489.00	£506.00
Y705748	1400 x 800 x 740	£508.00	£525.00
Y705749	1600 x 800 x 740	£525.00	£545.00
Y705750	1800 x 800 x 740	£540.00	£560.00

B. Rectangular tilt top tables 700mm deep

	W x D x H(mm)	Band 1	Band 2
Y705753	800 x 700 x 740	£429.00	£448.00
Y705754	1000 x 700 x 740	£440.00	£459.00
Y705755	1200 x 700 x 740	£459.00	£476.00
Y705756	1400 x 700 x 740	£479.00	£498.00
Y705757	1600 x 700 x 740	£499.00	£519.00
Y705758	1800 x 700 x 740	£514.00	£532.00

C. Trapezoidal tilt top tables

- Internal angles of the trapezoidal are 60° & 120°
- The depth is the length along the angled side

	W x D x H(mm)	Band 1	Band 2
Y705760	1600 x 800 x 740	£629.00	£649.00

D. Semi-circular tilt top tables

	W x D x H(mm)	Band 1	Band 2
Y705764	1600 x 800 x 740	£627.00	£649.00
Y705765	1800 x 900 x 740	£645.00	£669.00

E. Table top connectors

Y660960	Table Top Connector	pk 2	£40.00
---------	---------------------	------	--------

Top Finishes Band 1

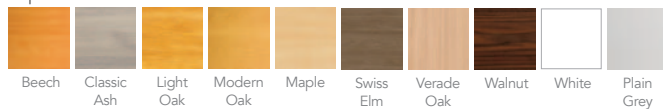

Top Finishes Band 2

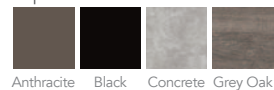

Standard Metalwork Finishes

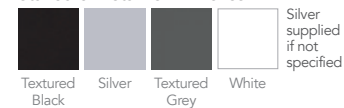

Wilmington Executive Boardroom Tables



A



B



Boat Shaped



D End



Oval

A. Rectangular executive boardroom table

- 2800mm, 3000mm, 3200mm & 3400mm tables are supplied with 2 tops, 1 leg frame & 2 supporting bars
- 3600mm – 4000mm tables are supplied with 2 tops, 2 leg frames and connecting plates

	W x D x H(mm)	Band 1	Band 2
Y705770	2000 x 1200 x 740	£815.00	£849.00
Y705771	2400 x 1200 x 740	£926.00	£965.00
Y705772	2600 x 1200 x 740	£1029.00	£1071.00
Y705773	2800 x 1200 x 740	£1080.00	£1126.00
Y705774	3000 x 1200 x 740	£1132.00	£1180.00
Y705775	3200 x 1200 x 740	£1236.00	£1288.00
Y705776	3400 x 1200 x 740	£1340.00	£1396.00
Y705777	3600 x 1200 x 740	£1439.00	£1499.00
Y705778	3800 x 1200 x 740	£1588.00	£1652.00
Y705779	4000 x 1200 x 740	£1734.00	£1799.00

B. Shaped boardroom table

- Please state choice of top: Oval, D End or Barrel Shaped

	W x D x H(mm)	Band 1	Band 2
Y705784	2000 x 1200 x 740	£1025.00	£1058.00
Y705785	2400 x 1200 x 740	£1073.00	£1113.00
Y705786	2600 x 1200 x 740	£1202.00	£1245.00
Y705787	2800 x 1200 x 740	£1263.00	£1310.00
Y705788	3000 x 1200 x 740	£1326.00	£1376.00
Y705789	3200 x 1200 x 740	£1456.00	£1508.00
Y705790	3400 x 1200 x 740	£1581.00	£1638.00
Y705791	3600 x 1200 x 740	£1708.00	£1765.00
Y705792	3800 x 1200 x 740	£1836.00	£1898.00
Y705793	4000 x 1200 x 740	£2052.00	£2117.00

Wilmington Meeting Tables



A. Circular tables

	W x D x H(mm)	Band 1	Band 2
Y705797	800 x 800 x 740	£499.00	£549.00
Y705798	900 x 900 x 740	£528.00	£579.00
Y705799	1000 x 1000 x 740	£568.00	£625.00
Y705800	1200 x 1200 x 740	£630.00	£690.00
Y705801	1600 x 1600 x 740	£799.00	£875.00

B. Square tables

	W x D x H(mm)	Band 1	Band 2
Y705805	800 x 800 x 740	£499.00	£549.00
Y705806	900 x 900 x 740	£528.00	£579.00
Y705807	1000 x 1000 x 740	£568.00	£625.00
Y705808	1200 x 1200 x 740	£630.00	£690.00
Y705809	1600 x 1600 x 740	£799.00	£875.00

C. Circular tables - trumpet base

	W x D x H(mm)	Band 1	Band 2
Y705812	800 x 800 x 740	£449.00	£465.00
Y705813	1000 x 1000 x 740	£479.00	£498.00
Y705814	1200 x 1200 x 740	£517.00	£536.00
Y705815	1400 x 1400 x 740	£579.00	£602.00

Top Finishes Band 1

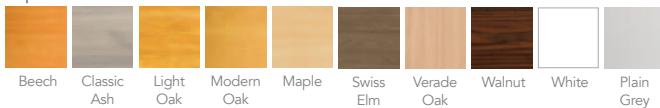

Top Finishes Band 2

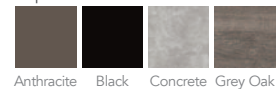

Wilmington Storage



Fixed pedestals

- 800mm deep

	Drawers	W x D x H(mm)	Band 1	Band 2
Y705818	2	426 x 577 x 505	£209.00	£239.00
Y705819	3	426 x 577 x 505	£209.00	£239.00



Fixed pedestals

- 600mm deep

	Drawers	W x D x H(mm)	Band 1	Band 2
Y705820	2	426 x 520 x 505	£209.00	£239.00
Y705821	3	426 x 520 x 505	£209.00	£239.00



Mobile tall under desk pedestal

- For 800mm deep desk

	Drawers	W x D x H(mm)	Band 1	Band 2
Y705824	2	438 x 550 x 635	£305.00	£339.00
Y705825	3	438 x 550 x 635	£305.00	£339.00
Y705826	4	438 x 550 x 635	£305.00	£339.00



Mobile tall under desk pedestal

- For 600mm deep desk

	Drawers	W x D x H(mm)	Band 1	Band 2
Y705829	2	438 x 514 x 635	£305.00	£339.00
Y705830	3	438 x 514 x 635	£305.00	£339.00
Y705831	4	438 x 514 x 635	£305.00	£339.00



Mobile tall slimline under desk pedestal

- For 800mm deep desk

	Drawers	W x D x H(mm)	Band 1	Band 2
Y705834	2	310 x 550 x 635	£309.00	£345.00
Y705835	3	310 x 550 x 635	£309.00	£345.00
Y705836	4	310 x 550 x 635	£309.00	£345.00



Mobile tall slimline under desk pedestal

- For 600mm deep desk

	Drawers	W x D x H(mm)	Band 1	Band 2
Y705840	2	310 x 514 x 635	£299.00	£329.00
Y705841	3	310 x 514 x 635	£299.00	£329.00
Y705842	4	310 x 514 x 635	£299.00	£329.00



Desk high pedestal

- 600mm deep

	Drawers	W x D x H(mm)	Band 1	Band 2
Y705845	2	438 x 600 x 740	£309.00	£349.00
Y705846	3	438 x 600 x 740	£309.00	£349.00
Y705847	4	438 x 600 x 740	£309.00	£349.00



Desk high slimline pedestal

- 600mm deep

	Drawers	W x D x H(mm)	Band 1	Band 2
Y705850	2	310 x 600 x 740	£292.00	£322.00
Y705851	3	310 x 600 x 740	£292.00	£322.00
Y705852	4	310 x 600 x 740	£292.00	£322.00



Desk high pedestal

- 800mm deep

	Drawers	W x D x H(mm)	Band 1	Band 2
Y705855	2	438 x 800 x 740	£332.00	£362.00
Y705856	3	438 x 800 x 740	£332.00	£362.00
Y705857	4	438 x 800 x 740	£332.00	£362.00



Desk high slimline pedestal

- 800mm deep

	Drawers	W x D x H(mm)	Band 1	Band 2
Y705860	2	310 x 800 x 740	£325.00	£359.00
Y705861	3	310 x 800 x 740	£325.00	£359.00
Y705862	4	310 x 800 x 740	£325.00	£359.00

Wilmington Storage



Desk high base unit

- 600mm deep

	W x D x H(mm)	Band 1	Band 2
Y705865	800 x 600 x 740	£389.00	£431.00
Y705866	1000 x 600 x 740	£425.00	£467.00
Y705867	1200 x 600 x 740	£477.00	£525.00



Desk high base unit glass doors

- 600mm deep

	W x D x H(mm)	Band 1	Band 2
Y705870	800 x 600 x 740	£625.00	£659.00
Y705871	1000 x 600 x 740	£683.00	£724.00
Y705872	1200 x 600 x 740	£748.00	£789.00



Credenza desk high base unit

- 600mm deep

	W x D x H(mm)	Band 1	Band 2
Y705873	1200 x 600 x 740	£510.00	£561.00



Sliding door desk high base unit

- 600mm deep

	W x D x H(mm)	Band 1	Band 2
Y705875	800 x 600 x 740	£484.00	£531.00
Y705876	1000 x 600 x 740	£554.00	£599.00
Y705877	1200 x 600 x 740	£614.00	£670.00
Y705878	1600 x 600 x 740	£753.00	£833.00



Small sideboard unit desk high

- 600mm deep

	Drawers	W x D x H(mm)	Band 1	Band 2
Y705880	Open	1200 x 600 x 740	£547.00	£599.00
Y705881	2	1200 x 600 x 740	£705.00	£775.00
Y705882	3	1200 x 600 x 740	£705.00	£775.00
Y705883	4	1200 x 600 x 740	£705.00	£775.00



Side filer desk high

- 600mm deep

	W x D x H(mm)	Band 1	Band 2
Y705884	800 x 600 x 740	£795.00	£839.00



Desk end bookcase desk high

- 90°

	W x D x H(mm)	Band 1	Band 2
Y705886	600 x 600 x 740	£406.00	£447.00
Y705887	800 x 800 x 740	£435.00	£478.00



Desk end tambour desk high

- 90°

	W x D x H(mm)	Band 1	Band 2
Y705890	800 x 800 x 740	£779.00	£819.00



Tambour desk high

- 600mm deep, 90°

	W x D x H(mm)	Band 1	Band 2
Y705891	800 x 600 x 740	£719.00	£749.00

Top Finishes Band 1

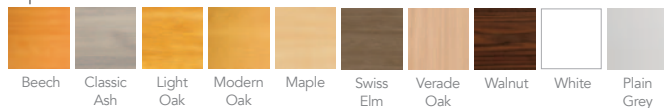

Top Finishes Band 2

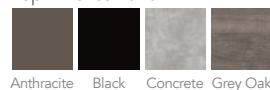

Wilmington Storage



Double door cupboards

- 800mm wide

	W x D x H(mm)	Band 1	Band 2
Y705900	800 x 410 x 740	£310.00	£330.00
Y705901	800 x 410 x 1000	£335.00	£380.00
Y705902	800 x 410 x 1200	£375.00	£420.00
Y705903	800 x 410 x 1600	£465.00	£505.00
Y705904	800 x 410 x 1800	£495.00	£565.00
Y705905	800 x 410 x 2000	£550.00	£600.00

- 1000mm wide

Y705908	1000 x 410 x 740	£340.00	£365.00
Y705909	1000 x 410 x 1000	£380.00	£430.00
Y705910	1000 x 410 x 1200	£450.00	£480.00
Y705911	1000 x 410 x 1600	£505.00	£570.00
Y705912	1000 x 410 x 1800	£565.00	£610.00
Y705913	1000 x 410 x 2000	£620.00	£665.00



Open bookcases

- 800mm wide

	W x D x H(mm)	Band 1	Band 2
Y705915	800 x 410 x 740	£189.00	£205.00
Y705916	800 x 410 x 1000	£199.00	£215.00
Y705917	800 x 410 x 1200	£225.00	£245.00
Y705918	800 x 410 x 1600	£295.00	£325.00
Y705919	800 x 410 x 1800	£319.00	£380.00
Y705920	800 x 410 x 2000	£360.00	£399.00

- 1000mm wide

Y705923	1000 x 410 x 740	£210.00	£250.00
Y705924	1000 x 410 x 1000	£235.00	£270.00
Y705925	1000 x 410 x 1200	£265.00	£300.00
Y705926	1000 x 410 x 1600	£365.00	£395.00
Y705927	1000 x 410 x 1800	£399.00	£445.00
Y705928	1000 x 410 x 2000	£429.00	£485.00



System storage 2 door cupboard

- These units accept Bisley accessories

	W x D x H(mm)	Band 1	Band 2
Y705931	955 x 580 x 740	£389.00	£445.00
Y705932	955 x 580 x 1000	£439.00	£489.00
Y705933	955 x 580 x 1200	£485.00	£550.00
Y705934	955 x 580 x 1600	£545.00	£620.00
Y705935	955 x 580 x 1800	£599.00	£689.00
Y705936	955 x 580 x 2000	£690.00	£769.00

Accessories to be ordered separately

We recommend all units over 1200mm tall are fitted to the wall for safety purposes. Please contact us for a quotation



System storage tambour cupboard

- These units accept Bisley accessories

	W x D x H(mm)	Band 1	Band 2
Y705940	1100 x 531 x 740	£573.00	£629.00
Y705941	1100 x 531 x 1000	£646.00	£699.00
Y705942	1100 x 531 x 1200	£723.00	£780.00
Y705943	1100 x 531 x 1600	£790.00	£855.00
Y705944	1100 x 531 x 1800	£867.00	£935.00
Y705945	1100 x 531 x 2000	£937.00	£999.00

Accessories to be ordered separately



Filing cabinets

	Drawers	W x D x H(mm)	Band 1	Band 2
Y705948	2	484 x 658 x 740	£340.00	£385.00
Y705949	3	484 x 658 x 1048	£425.00	£470.00
Y705950	4	484 x 658 x 1360	£520.00	£560.00

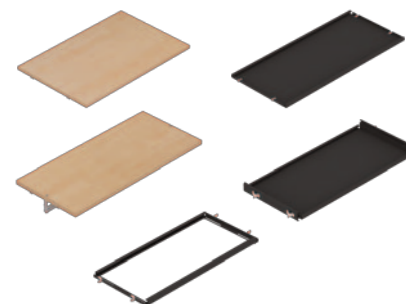

Cupboard Accessories

Y705952	Wooden Shelf (State for which unit)	£59.00
Y705953	Metal Standard Shelf	£44.00
Y705954	Wardrobe Shelf with Rail	£79.00
Y705955	Lateral Filing Rail	£54.00
Y705956	Roll Out Suspension Filing Frame	£174.00

Wilmington Residential

- Choice of mattresses available
- Made in the UK
- Mattresses have passed fire standard for contract use
- Call for best pricing



Budget bed

- Mattress base height: 400mm

	To Fit	W x D x H(mm)	Band 1	Band 2
Y705960	Single	1946 x 968 x 960	£520.00	£572.00
Y705961	¾ (4')	1946 x 1278 x 960	£627.00	£690.00
Y705962	Double	1946 x 1428 x 960	£690.00	£758.00



Storage bed

- Mattress base height: 400mm

	To Fit	W x D x H(mm)	Band 1	Band 2
Y705964	Single	1946 x 968 x 960	£595.00	£652.00
Y705965	¾ (4')	1946 x 1278 x 960	£699.00	£770.00
Y705966	Double	1946 x 1428 x 960	£765.00	£840.00



Premium student bed

- Mattress base height 400mm
- Includes headboard, wall protector, 3x underbed drawers on 40kg ball bearing runners
- Scalloped handles, extra support under bed base.

	To Fit	W x D x H(mm)	Band 1	Band 2
Y705968	Single	2354 x 968 x 960	£1484.00	£1632.00
Y705969	¾ (4')	2354 x 1273 x 960	£1542.00	£1695.00
Y705970	Double	2354 x 1425 x 960	£1574.00	£1730.00



Drawer Detail



Student storage bed

- Mattress base height 400mm
- Includes underbed storage as well as side storage

	To Fit	W x D x H(mm)	Band 1	Band 2
Y705974	¾ (4')	1946 x 1278 x 960	£770.00	£848.00
Y705975	Double	1946 x 1428 x 960	£848.00	£930.00



Premium student drawer bed

- Mattress base height 400mm
- Includes headboard, 6x underbed drawers on 40kg ball bearing runners
- Scalloped handles, extra support under bed base.

	To Fit	W x D x H(mm)	Band 1	Band 2
Y705977	¾ (4')	2354 x 1273 x 960	£1542.00	£1695.00
Y705978	Double	2354 x 1425 x 960	£1574.00	£1730.00



Wilmington Residential

The Wilmington Residential range of furniture is perfect for student accommodation in colleges and universities. Designed for endurance, we like to call this heavy duty furniture. With a 10 year guarantee, you will be hard pressed to find a more cost-effective long term solution.

Whilst the below items are technically 'off-the-shelf' items, for larger projects that are often led by architects plans, our in-house design team can work closely with you to create a solution that complements their design whilst advising on what is suitable for the environment the furniture is being used in.

A range of matching top boxes, coat hooks, tables and wall protectors are available - please ask for details.

A



B



C



D



We recommend all units over 1200mm tall are fitted to the wall for safety purposes. Please contact us for a quotation

A. Single wardrobe

- Left hand hinged as standard unless specified otherwise
- Top shelf, hanging rail and bottom shelf
- Non locking

	W x D x H(mm)	Band 1	Band 2
Y705980	439 x 600 x 1850	£452.00	£497.00

B. Single wardrobe with 2 drawers

- Left hand hinged as standard unless specified otherwise
- Top shelf, hanging rail and bottom shelf
- Non locking

	W x D x H(mm)	Band 1	Band 2
Y705981	439 x 600 x 1850	£546.00	£607.00

C. Double wardrobe

- Top shelf, hanging rail and bottom shelf
- Non locking.

	W x D x H(mm)	Band 1	Band 2
Y705982	800 x 600 x 1850	£610.00	£670.00

D. Double wardrobe with 2 drawers

- Top shelf, hanging rail and 2 drawers
- Non locking.

	W x D x H(mm)	Band 1	Band 2
Y705983	800 x 600 x 1850	£729.00	£799.00

Top Finishes Band 1

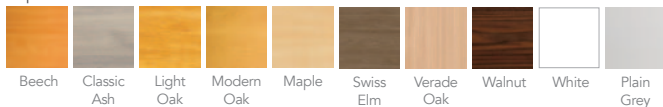

Top Finishes Band 2

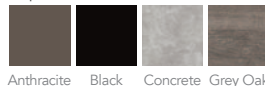

Wilmington Residential

A. Chest of drawers

	Drawers	W x D x H(mm)	Band 1	Band 2
Y705986	3	800 x 595 x 725	£415.00	£457.00
Y705987	4	800 x 595 x 950	£510.00	£561.00
Y705988	5	800 x 595 x 1179	£603.00	£665.00



B. Bedside cabinet 1

- 25mm top
- Rounded corners on top for safety
- Please specify right or left hand hinged
- Non Locking as standard

	W x D x H(mm)	Band 1	Band 2
Y705990	438 x 560 x 648	£328.00	£362.00



C. Bedside cabinet 2

- 25mm top
- Rounded corners on top for safety
- Non Locking as standard

	W x D x H(mm)	Band 1	Band 2
Y705992	438 x 560 x 648	£262.00	£289.00



D. Bedside cabinet 3

- 25mm top
- Rounded corners on top for safety
- Non Locking as standard

	W x D x H(mm)	Band 1	Band 2
Y705994	438 x 560 x 648	£354.00	£390.00



E. Dressing table

- 25mm top
- Rounded corners on top for safety
- Non Locking as standard

	W x D x H(mm)	Band 1	Band 2
Y705995	1200 x 595 x 725	£453.00	£499.00
Y705996	1600 x 595 x 725	£776.00	£854.00



F. Wall mountable bookcase

- 25mm shelves
- Wall fixings/mounts are not provided

	W x D x H(mm)	Band 1	Band 2
Y705997	800 x 330 x 600	£180.00	£199.00
Y705998	1000 x 330 x 600	£211.00	£231.00



8 Year
WarrantyNew
Product

Arlington Contract Range

The Arlington is a versatile, entry-level design that refuses to go out of style. Sturdy enough to withstand the fast-paced 9 to 5 lifestyle yet sleek in appearance. Boasting a wide range of configurations, it is available with cantilever or panel end leg. Storage options to complement these desks come with fixed, mobile or desk high pedestals.

- 18mm back modesty panel
- Sturdy 25mm tops
- All desks 725mm high
- Available in 3 colours – please specify when ordering
- Adjustable feet

Cantilever Leg Frame



A. Rectangular Workstations

Y745900	L800 x D800mm	£242.00
Y745901	L1000 x D800mm	£248.00
Y745902	L1200 x D800mm	£256.00
Y745903	L1400 x D800mm	£263.00
Y745904	L1600 x D800mm	£276.00
Y745905	L1800 x D800mm	£302.00



B. Crescent Desk Right Hand

Y745910	L1400 x D1200mm	£359.00
Y745911	L1600 x D1200mm	£389.00
Y745912	L1800 x D1200mm	£429.00



C. Crescent Desk Left Hand

Y745913	L1400 x D1200mm	£359.00
Y745914	L1600 x D1200mm	£389.00
Y745915	L1800 x D1200mm	£429.00



D. Crescent Desk Right Hand with Pedestal

Y745920	L1600 x D1200mm	2 Drawer	£578.00
Y745921	L1800 x D1200mm	2 Drawer	£626.00
Y745922	L1600 x D1200mm	3 Drawer	£578.00
Y745923	L1800 x D1200mm	3 Drawer	£626.00



E. Crescent Desk Left Hand with Pedestal

Y745924	L1600 x D1200mm	2 Drawer	£578.00
Y745925	L1800 x D1200mm	2 Drawer	£626.00
Y745926	L1600 x D1200mm	3 Drawer	£578.00
Y745927	L1800 x D1200mm	3 Drawer	£626.00



F. Filing cabinets

		Drawers	
Y745980	H730 x W480 x D650mm	2	£335.00
Y745981	H1045 x W480 x D650mm	3	£395.00
Y745982	H1360 x W480 x D650mm	4	£465.00



G. Desk high pedestals

		Drawers	
Y745974	H725 x W426 x D600mm	3	£325.00
Y745975	H725 x W426 x D800mm	3	£355.00



H. Tall mobile pedestals

		Drawers	
Y745972	H630 x W300 x D600mm	3	£325.00
Y745973	H630 x W426 x D600mm	3	£335.00

Wood colours

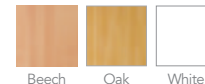

Beech

Oak

White

Wood & colour finishes may not be representative of actual colours - please ask for a sample

Frame colours



Silver

Graphite

Arlington Contract Range

Panel Leg Frame

8 Year
Warranty

New
Product



I. Rectangular Workstations

Y745930	L800 x D800mm	£229.00
Y745931	L1000 x D800mm	£235.00
Y745932	L1200 x D800mm	£245.00
Y745933	L1400 x D800mm	£255.00
Y745934	L1600 x D800mm	£265.00
Y745935	L1800 x D800mm	£285.00

Page Link - see page
For
Universal
Storage

348



J. Crescent Desk Right Hand

Y745940	L1400 x D1200mm	£389.00
Y745941	L1600 x D1200mm	£405.00
Y745942	L1800 x D1200mm	£446.00



K. Crescent Desk Left Hand

Y745945	L1400 x D1200mm	£389.00
Y745946	L1600 x D1200mm	£405.00
Y745947	L1800 x D1200mm	£446.00



L. Crescent Desk Right Hand with Pedestal

Y745950	L1600 x D1200mm	2 Drawer	£559.00
Y745951	L1800 x D1200mm	2 Drawer	£579.00
Y745952	L1600 x D1200mm	3 Drawer	£559.00
Y745953	L1800 x D1200mm	3 Drawer	£579.00



M. Crescent Desk Left Hand with Pedestal

Y745954	L1600 x D1200mm	2 Drawer	£559.00
Y745955	L1800 x D1200mm	2 Drawer	£579.00
Y745956	L1600 x D1200mm	3 Drawer	£559.00
Y745957	L1800 x D1200mm	3 Drawer	£579.00



N. Open Bookcases

		Shelves	
Y745960	H830 x W 756 x D390mm	1	£189.00
Y745961	H1230 x W 756 x D390mm	2	£220.00
Y745962	H1630 x W 756 x D390mm	3	£286.00
Y745963	H2030 x W 756 x D390mm	4	£320.00



O. Double Door Cupboards

		Shelves	
Y745964	H830 x W 756 x D408mm	1	£295.00
Y745965	H1230 x W 756 x D408mm	2	£325.00
Y745966	H1630 x W 756 x D408mm	3	£412.00
Y745967	H2030 x W 756 x D408mm	4	£519.00

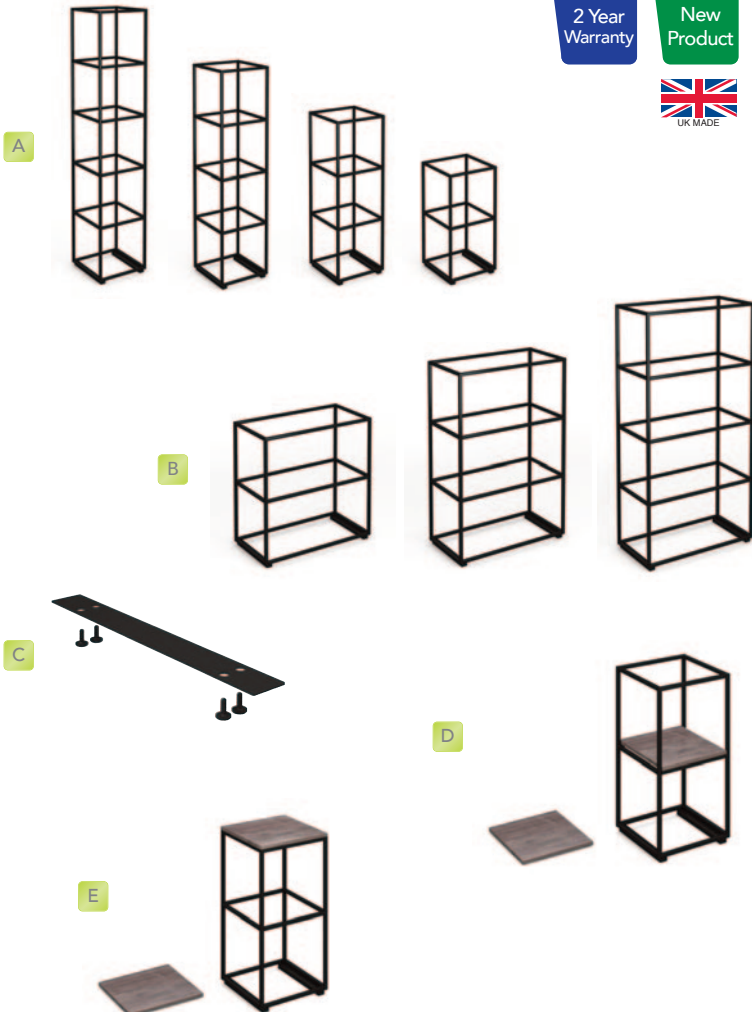

Chalvington Modular Shelving

The Chalvington modular shelving range epitomises the future of adaptable modern design. This system has infinite layout options and shapes to create work zones in any space to promote privacy or transparency as needed.

- Configure in an infinite number of ways to suit any space
- A modular grid based storage/shelving system for adaptable, flexible spaces
- Fully welded frame construction for easy installation and added strength
- Wooden add-ons and inserts in a selection of finishes and styles

A. Single Starter Units

- Two and three high tower units supplied with 1 linking bracket
- Four and five high tower units supplied with 2 linking brackets

W x D x Hmm

Y745985	420 x 420 x 845	2 High	£359.00
Y745986	420 x 420 x 1245	3 High	£455.00
Y745987	420 x 420 x 1645	4 High	£560.00
Y745988	420 x 420 x 2045	5 High	£640.00

B. Double Starter Units

- Two and three high tower units supplied with 1 linking bracket
- Four and five high tower units supplied with 2 linking brackets

W x D x Hmm

Y745989	820 x 420 x 845	2 High	£400.00
Y745990	820 x 420 x 1245	3 High	£530.00
Y745991	820 x 420 x 1645	4 High	£640.00
Y745992	820 x 420 x 2045	5 High	£685.00

C. Linking Bracket

- Add extra linking brackets to large configurations for increased stability

Y745993	Linking Bracket	£22.00
---------	-----------------	--------

D. Inner Shelves

Shelves W x D x Hmm

Y745994	Single	380 x 420 x 25	£49.00
Y745995	Double	780 x 420 x 25	£69.00

E. Top Shelves

Top Shelves W x D x Hmm

Y745996	Single	420 x 420 x 25	£59.00
Y745997	Double	820 x 420 x 25	£75.00
Y745998	Triple	1220 x 420 x 25	£85.00

F. Cubbies

- Single or double cubby unit to sit inside frame
- Create the perfect storage solution or display

	Unit	W x D x Hmm	
Y745999	Single	380 x 420 x 380	£95.00
Y746000	Double	780 x 420 x 380	£112.00
Y746001	Single Half	380 x 420 x 195	£89.00



F



G. Planters

		W x D x Hmm	
Y746002	Single	420 x 420 x 195	£139.00
Y746003	Double	820 x 420 x 195	£165.00



H



G

H. Locker Unit

- Fully lockable locker unit to fit inside frame
- Keep valuables and technology safe and secure

	W x D x Hmm	
Y746004	380 x 420 x 380	£199.00



I. Cube Seating

- Fully upholstered cube seat to fit inside frame
- Colourful modern addition to enhance any workspace

	W x D x Hmm	
Y746005	380 x 420 x 380	£189.00

Colour Options Unlimited fabrics available
Prices shown are for Era, Phoenix, Rivet & X2 - see pages 284-286. Please contact us for prices on other fabrics.



J



I

J. Triple Unit with Seat

- Triple wide 5 high tower unit with central cutaway
- Padded seat and sides in fabric of your choice

	W x D x Hmm	
Y746006	1220 x 420 x 2045	£999.00

Colour Options Unlimited fabrics available
Prices shown are for Era, Phoenix, Rivet & X2 - see pages 284-286. Please contact us for prices on other fabrics.

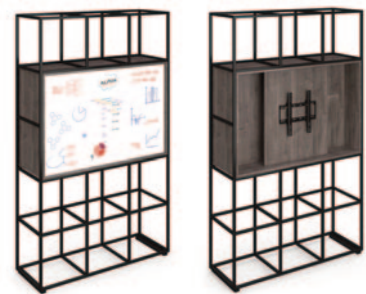

K

K. Triple Unit with Media Unit

- Triple wide 5 high tower unit with two sided media unit
- Media unit with cable management for TV and whiteboard on reverse

	W x D x Hmm	
Y746007	1220 x 420 x 2045	£1199.00

Wood & colour finishes may not be representative of actual colours - please ask for a sample

Wood colours

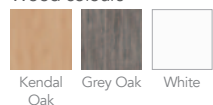

Frame colour



A

New
Product2 Year
Warranty

A. Chalvington Sit-Stand Desk

Having the option to stand as well as sit during the work day has been proven not only to benefit the health of the user but also of the business, dramatically improving health, well-being and energy levels of the workplace. The single motor enables the user to electronically adjust the height from a sitting to a standing position with the touch of a button.

- 25mm desktops
- Single straight desks with height adjustability from 700mm to 1200mm

H x W x Dmm

Y746010	700-1200 x 1200 x 800mm	£639.00
Y746011	700-1200 x 1400 x 800mm	£669.00
Y746012	700-1200 x 1600 x 800mm	£699.00

B



B. Chalvington Sit-Stand Desk Bundle

- Get the complete package desk bundle – comprising a 1600mm desk complete with a double monitor arm, cable management tray and a steel 3 drawer pedestal

H x W x Dmm

Y746013	700-1200 x 1600 x 800mm	£940.00
---------	-------------------------	---------

Wood colours



Beech Grey Oak Oak Walnut White White Oak

Wood & colour finishes may not be representative of actual colours - please ask for a sample

Frame colours



Silver White

C



C. Vertical Expanding Cable Spiral

- For use with Chalvington Sit-stand desks
- Simple solution which extends with the desk to carry cables from the floor to desktop

Y748015	H150-1300mm x 70mm	Black	£75.00
Y748016	H150-1300mm x 70mm	Silver	£75.00
Y748017	H150-1300mm x 70mm	White	£75.00

Vermont Height Adjustable Desking

Rectangle height adjustable desk (electric)

With a range of options and height settings, our height adjustable workstations give you the opportunity to create an office space that showcases your style whilst meeting your DDA requirements.

- 25mm Tops
- Adjustment range 710mm – 1210mm
- White or Silver Frames
- Black frames available on request
- 5 year Guarantee

Want to re-use an existing top? All items can be purchased 'frame only' – Please call for prices.

White Frame

Y700350	1200 x 800mm	£699.00
Y700352	1400 x 800mm	£715.00
Y700354	1600 x 800mm	£725.00
Y700356	1800 x 800mm	£745.00

Silver Frame

Y700358	1200 x 800mm	£699.00
Y700360	1400 x 800mm	£715.00
Y700362	1600 x 800mm	£725.00
Y700364	1800 x 800mm	£745.00



5 Year
Warranty

Corner height adjustable desk

The Vermont Corner height adjustable desk has all of the advantages of the popular Vermont rectangular desk, with a smooth-operating triple motor system and overload protection as standard. Perfect for executive use, giving extra workspace for printers and storage.

- Black frames available on request

White Frame

Y700366	1600 x 1600mm	£1085.00
Y700368	1800 x 1600mm	£1129.00

Silver Frame

Y700370	1600 x 1600mm	£1085.00
Y700372	1800 x 1600mm	£1129.00

Please state Left or Right Hand at point of ordering.



Finishes



Beech Carbon Marine Nebraska Oak Grey Maple Oak Walnut Wenge White

5 Year
WarrantyNew
Product

A



B



C



D



E



Chalvington Universal Storage

Offering versatile and practical storage solutions, this range will keep your office organised and looking neat and tidy. Cupboards and bookcases with their minimal, modern styling are a practical group of units that will sit comfortably in an office space without dominating it, available in wood finishes to match the Arlington desk range.

- 18mm carcass and solid back panel
- Available in four height options
- Available in Beech, Oak, and White
- Supplied flat packed for easy handling
- Supplied with fixed or adjustable shelves depending on size

A. Universal Bookcases

- Supplied with shelves

	H x W x D(mm)	Shelves	
Y746015	740 x 800 x 470	1 Desk High	£209.00
Y746016	1090 x 800 x 470	2	£229.00
Y746017	1440 x 800 x 470	3	£319.00
Y746018	1790 x 800 x 470	4	£389.00
Y746019	2140 x 800 x 470	5	£419.00

B. Universal Cupboards

- Lockable wooden doors
- Supplied with shelves

	H x W x D(mm)	Shelves	
Y746020	740 x 800 x 470	1 Desk High	£345.00
Y746021	1090 x 800 x 470	2	£385.00
Y746022	1440 x 800 x 470	3	£480.00
Y746023	1790 x 800 x 470	4	£595.00
Y746024	2140 x 800 x 470	5	£685.00

C. Universal Combination Unit with open Top

- Lockable wooden doors
- Supplied with shelves

	H x W x D(mm)	Shelves	
Y746025	1440 x 800 x 470	3	£448.00
Y746026	1790 x 800 x 470	4	£548.00
Y746027	2140 x 800 x 470	5	£616.00

D. Universal Combination Unit with Glass Upper Doors

- Lockable wooden doors
- Supplied with shelves

	H x W x D(mm)	Shelves	
Y746028	1440 x 800 x 470	3	£635.00
Y746029	1790 x 800 x 470	4	£750.00
Y746030	2140 x 800 x 470	5	£820.00

E. Universal Single Door Tambour Cupboard

- Space-saving single opening tambour folds into the side to make best use of space
- Smooth action door with inset handle and lock for security

	H x W x D(mm)	Shelves	
Y746031	1090 x 800 x 470	2	£669.00
Y746032	2140 x 800 x 470	5	£935.00

Page Link - see pages

For Filing
Cabinets

342



Wood colours



*Beech Grey Oak *Oak Walnut *White

Wood & colour finishes may not be representative of actual colours - please ask for a sample

* Items D and E are only available in Beech, Oak and White

Pigeon Hole Units

High Quality, long lasting construction. These units are solid and heavy but we have designed them as modular parts which simply connect together with the supplied fixings. Ideal for sorting post & distributing mail.

- Manufactured from quality 18mm laminate
- All shelves are fully adjustable with 32mm hole spacings
- The clear acrylic shelves come complete with a label holder for the front
- Our pigeonhole range is available in a choice of 5 Wood finishes. BEECH, MAPLE, LIGHT OAK, GREY and WHITE
- Other pigeon hole combinations available, please call for details

A. 36 pigeon hole storage with cupboard

- Size: W826 x H1930 x D375mm

Y701101 36 Hole Unit £955.00

B. 48 pigeon hole storage with cupboard

- Size: W1094 x H1930 x D375mm

Y701102 48 Hole Unit £1205.00

C. 72 pigeon hole storage

- Size: W1094 x H1930 x D375mm

Y701103 72 Hole Unit £1205.00



Page Link - see page
For soft seating... ➔ 215



D. Wilmington document sorter unit

- 25mm Top & Shelves
- Compartment size 240W x 190H
- Supplied assembled

	W x D x H(mm)	Band 1	Band 2
Y701860	800 x 332 x 1102	£542.00	£596.00



Top Finishes Band 1

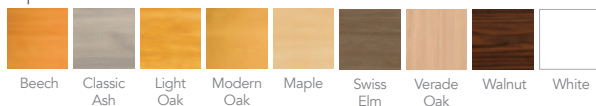

Top Finishes Band 2

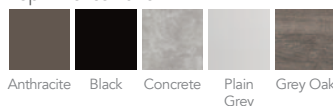

Bespoke sizes available
- please enquire



Wilmington A Meeting & Poseur

A bold and characterful tabling system for modern, vibrant working environments. With its chunky steel underframe, these tables and benches carry serious presence!

These can be used with soft seating or conference chairs.

- 25mm Tops
- 740mm standard or 1050mm Poseur height
- 'A' profile leg
- Can be supplied in 800mm or 1000mm desk depth – ask for prices

A. Wilmington A poseur tables

	W x D x H(mm)	Band 1	Band 2
Y701877	1400 x 900 x 1050	£851.00	£839.00
Y701879	1800 x 900 x 1050	£886.00	£912.00
Y701880	2000 x 900 x 1050	£921.00	£947.00

B. Wilmington A standard tables

	W x D x H(mm)	Band 1	Band 2
Y701855	1400 x 900 x 740	£807.00	£828.00
Y701887	1800 x 900 x 740	£840.00	£865.00
Y701888	2000 x 900 x 740	£879.00	£901.00

C. Wilmington A standard benches

	W x D x H(mm)	Fits Bench	Band 1	Band 2
Y701895	1100 x 350 x 455	1400mm	£315.00	£323.00
Y701897	1500 x 350 x 455	1800mm	£341.00	£352.00
Y701898	1700 x 350 x 455	2000mm	£358.00	£369.00



Top Finishes Band 1

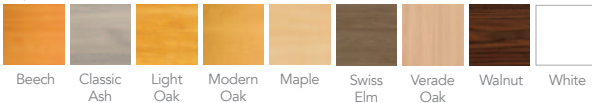

Top Finishes Band 2

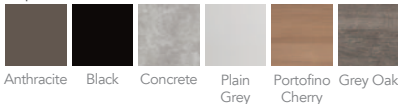

Page Link - see page
For Spar
dining
chairs ... **196**



Desk Top Colour Options

Group 1 Colours

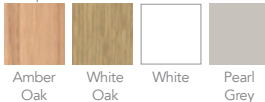

Wood & colour finishes may not be representative of actual colours - please ask for a sample

Group 2 Colours

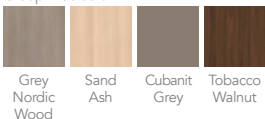

Page Link - see page
For Nova
Wood
Benching... **316**



Nova Wood High Tables

The high multipurpose table can complement many learning or office environments. The Nova Wood adds a delicate sense of luxury to the office and brings you closer to nature and a home atmosphere!

Ideal in open plan offices where you can arrange different areas for individual or collaborative work, meetings or leisure activities. Every table is unique due to solid ash wood legs:

- Wood texture and wide growth rings create a distinctive pattern
- Stained and lacquered wood reveals the pattern even more
- Natural wood tends to change its colour over time
- 25mm MFC top
- 900mm and 1050mm high options

Y702740	L1200 x W700 x H900mm	£1230.00
Y702741	L1400 x W700 x H900mm	£1275.00
Y702742	L1600 x W700 x H900mm	£1316.00
Y702743	L1800 x W700 x H900mm	£1370.00

Y702744	L1200 x W700 x H1050mm	£1287.00
Y702745	L1400 x W700 x H1050mm	£1330.00
Y702746	L1600 x W700 x H1050mm	£1373.00
Y702747	L1800 x W700 x H1050mm	£1425.00

New Product

A. Arundel Worktables

The Arundel worktables transition the workplace from one that is fixed and formal to a space that suits a variety of preferences and working habits. Dining and poseur height tables are a creative, practical solution for any meeting area or breakout space, but components can be added and combined in limitless ways to create flexible, fluid work areas where people gather, keeping people connected to their technology and each other.

- Dining or Poseur Height
- Solid timber legs with sturdy white metal underframe
- Poseur height tables with foot ring for added stability



		H x W x D(mm)	
Y748040	Square	725 x 800 x 800	£600.00
Y748041	Rectangular	725 x 1800 x 800	£690.00
Y748042	Square	1100 x 800 x 800	£895.00
Y748043	Rectangular	1100 x 1800 x 800	£995.00



A

B. Matching Seating

- Solid wood base and fully upholstered curved seat

		H x W x D(mm)	
Y746046	Bench	475 x 1200 x 380	£515.00
Y746047	Low Stool	475 x 380 x 380	£379.00

Colour Options Unlimited fabrics available
Prices shown are for Era, Phoenix, Rivet & X2 - see pages 284-286.
Please contact us for prices on other fabrics.



B

C. Arundel Meeting Tables

The Arundel meeting tables provide a more modern, intelligent approach to table solutions in meeting rooms or breakout zones. Available in both a dining or poseur height and with an optional power bar which contains 2x UK sockets and 2x USB (A&C) charging points. The tops are manufactured from MDF with stylish chamfered edges.

		H x W x D(mm)	
Y746050	Dining Table	755 x 1600 x 800	£1615.00
Y746051	Dining Table	755 x 2000 x 800	£1995.00
Y746052	Table with Power Bar	805 x 2000 x 1000	£3990.00



C

D. Arundel Poseur Hight Worktables

- Great for collaboration, work or breaktimes

		H x W x D(mm)	
Y746053	Table	1050 x 1600 x 800	£1855.00
Y746054	Table	1050 x 2000 x 800	£2235.00
Y746055	Table w/Power Bar	1150 x 2000 x 1000	£4995.00



D



Curved Top & Floor Standing Screens



Straight Top



Wave Top



Freestanding Screen Feet



Table Top Clamp

Screens

- Freestanding screens with feet, desk mountable screens, clip on screens in a variety of heights, fabrics and colours to suit your needs
- We can also supply screens made to any specific size or shape, with different features such as glazed tops, aluminium side trims, stabilising disc feet
- Available with PVC or fabric trim, free-standing
- Talk to us and we'll find the right solution for your needs
- Less than 2 screens may require a carriage charge, please check at time of ordering

A. Nimbus floor standing screens

- Free-standing screens come with two feet and can be fitted with linking strips (this must be specified at the time of order and will incur a small extra charge)
- The screen has a fabric trim as standard but can be supplied with grey or wood effect PVC trim at a small extra charge
- Available as standard or linked screens

Size(mm)	Standard		Linked	
	Code	Price	Code	Price
w1200 x h1200	YFS1212	£184.00	YLS1212	£205.00
w1000 x h1500	YFS1015	£206.00	YLS1015	£225.00
w1200 x h1500	YFS1215	£206.00	YLS1215	£225.00
w1500 x h1500	YFS1515	£228.00	YLS1515	£247.00
w1600 x h1500	YFS1615	£244.00	YLS1615	£264.00
w1200 x h1800	YFS1218	£235.00	YLS1218	£254.00
w1600 x h1800	YFS1618	£274.00	YLS1618	£294.00

For wave top add WV to code

POA

B. Nimbus desk mounted screens

- Clamp-on version

Wave

YWDT1200	W1200 x H280-480mm	£125.00
YWDT1400	W1400 x H280-480mm	£132.00
YWDT1600	W1600 x H280-480mm	£139.00
YWDT1800	W1800 x H280-480mm	£148.00

Straight

YSDT1200	W1200 x H480mm	£114.00
YSDT1400	W1400 x H480mm	£125.00
YSDT1600	W1600 x H480mm	£131.00
YSDT1800	W1800 x H480mm	£142.00

Curved

YCDT1200	W1200 x H180-380mm	£125.00
YCDT1400	W1400 x H180-380mm	£132.00
YCDT1600	W1600 x H180-380mm	£139.00
YCDT1800	W1800 x H180-380mm	£148.00

Bespoke sizes available
– please enquire

Colour Options Please ask for Cara or Lucia Fabric Swatch

Fabric Screens

A. Aluminium end posts, plastic top caps

Size	Group 1 Fabrics Code	Price	Group 2 Fabrics Code	Price
W1200 x H380	700400	£149.00	700430	£175.00
W1400 x H380	700401	£159.00	700431	£185.00
W1600 x H380	700402	£179.00	700432	£210.00
W1800 x H380	700403	£189.00	700433	£230.00



A

B. Aluminium frame, single tool rail

- Not suitable for monitor mount

Size	Group 1 Fabrics Code	Price	Group 2 Fabrics Code	Price
W1200 x H380	700410	£159.00	700440	£185.00
W1400 x H380	700411	£167.00	700441	£198.00
W1600 x H380	700412	£193.00	700442	£226.00
W1800 x H380	700413	£206.00	700443	£244.00



C

C. Aluminium frame, triple tool rail

Size	Group 1 Fabrics Code	Price	Group 2 Fabrics Code	Price
W1200 x H380	700420	£182.00	700450	£208.00
W1400 x H380	700421	£208.00	700451	£238.00
W1600 x H380	700422	£233.00	700452	£266.00
W1800 x H380	700423	£264.00	700453	£302.00



Pencil Pot

Name Holder

Trinket Pot

D

D. Screen hung accessories

A range of accessories suitable for the desk screen tool rails

Y700470	Pencil Pot	£23.00
Y700471	Name Holder	£20.00
Y700473	Trinket Pot	£21.00
Y700474	Letter Tray A3	£33.00
Y700475	Letter Tray A4	£24.00
Y700476	Screen Mounted Pole Monitor Arm	£104.00



Letter Tray A3

Letter Tray A4

Screen Mounted Pole Monitor Arm



A

Spare Fuse
In Every
Socket



Cable Management

A. Alpine desk top power modules

- Power and Data where you want it, with added flexibility
- Many choices of configuration of data, power and switches
- Has a spare fuse in every socket
- Can be clamped to the back of the desk in various permutations with the unique fittings on the back of the module (Screen Toolbar mount Also Available)
- Each is supplied with Unique Desk Fittings, 300mm Lead to 3 pole connector and a spare fuse per socket
- Available in White, silver and black

		With* 2M Lead
DTM2P1S	2 x UK Sockets 1 x Neon Switch	£73.00
DTM2P2D1S	2 x UK Sockets 1 x Neon Switch 2 x RJ45 Cat5e Data	£95.00
DTM4P2D1S	4 x UK Sockets 1 x Neon Switch 1 x USB-A, 1 x USB-C charge ports	£138.00

* Other Lead Lengths Available
Many further options available, please call for details

Page Link - see page

For Monitor
Risers

356



B

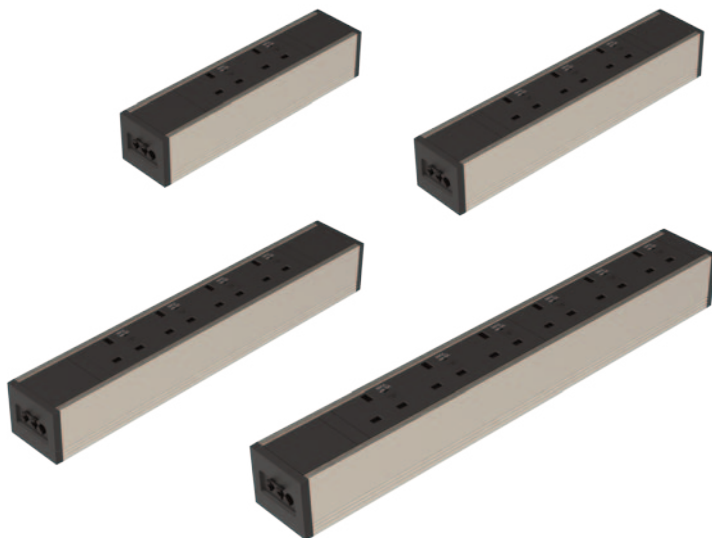

B. Alpine underdesk power modules

- Unique Design with a spare fuse for each socket so minimum downtime if a fuse fails
- Can be fixed underneath the desk
- Each Module may be linked directly to another – including data housings- to achieve the most complex of requirements quickly, easily and cost effectively
- Various Combinations
- Various Lengths of mains, connector and data leads available (see page opposite)
- Power cable to be ordered separately (see page 355)

Y701904	2 x UK Individually Fused 5A No Switches	£32.00
Y701905	3 x UK Individually Fused 5A No Switches	£34.00
Y701906	4 x UK Individually Fused 5A No Switches	£35.00
Y701907	6 x UK Individually Fused 5A No Switches	£49.00

Cable Management

A. Mains leads

- Ordered separately for Underdesk Power Modules

ML2	2M UK Plug To 3 Pole Connector	£9.95
ML3	3M UK Plug To 3 Pole Connector	£12.50
ML5	5M UK Plug To 3 Pole Connector	£16.50

Other Lead Lengths Available-please call for details



A

B. Connector leads

- Must be ordered separately for Underdesk Power Modules if connecting to other modules

CON1M	1M 3 Pole Male to Female Connector	£9.35
CON2M	2M 3 Pole Male to Female Connector	£11.00



B

C. Cat5e booted data leads

- Must be ordered separately for Underdesk Data Housings

DL2	2M RJ45 Cat5E Data Lead	£2.99
DL4	4M RJ45 Cat5E Data Lead	£4.99
DL5	5M RJ45 Cat5E Data Lead	£5.49
DL10	10M RJ45 Cat5E Data Lead	£7.69

Other lead lengths available-please call for details



C

D. Power desk inserts 80mm

- These power modules sit nicely to a standard 80mm grommet hole allowing the user convenient access to a combination of power, data and smart charge USB
- Ideal for charging phones and tablets
- Available in Silver/White, Silver/Grey, Silver/Black
- Other socket combinations available, POA

Y700520	1 Power, 1 x USB-A 2.5m*	£72.00
Y700521	1 Power, 1 x USB-A, 2 x USB-C*	£99.00
Y700522	1 Power, 1 x USB-A, 2 x USB-C, 1 x HDMI*	£109.00

* Power cable must be ordered separately



Y700520



Y700521



Y700522

D

A

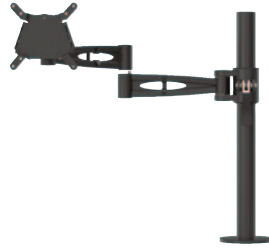

Available in twin & quad arms



Quick release height adjustment



Quick release VESA Mounting Plate Feature



Tool Rail Mounted Arm

Monitor Arms

A. Roma monitor arms

- Removable VESA mounting plate
- Quick release height adjustment
- Complete cable management
- Includes clamp and through desk fixing
- Available in black, silver and white

PMA521	Pole Mounted Monitor Arm for Single Screen 12.5kg	£84.00
PMA522	Pole Mounted Monitor Arms for Twin Screens 10kg x 2	£124.00
PMA524	Pole Mounted Monitor Arms for 4 Screens 8kg x 4	£222.00
PMSA521	Tool Rail Mounted Pole Monitor Arm for Single Screen 10kg	£94.00

B



B. Palermo premium gas lift monitor arm

- One touch height adjustment
- Quick release VESA mount
- Smooth gas lift
- Supports screens 2-10kg
- Black or white - please specify when ordering

Y701870	Gas Lift Monitor Arm	£149.00
---------	----------------------	---------

C



C. Palermo premium twin monitor rail

- Quick Release attachment
- Fits up to 27" monitors
- Tactile tilt & rotation adjustment
- Easy install – no tools required
- Adaptor only supplied. Item Y701870 (above) purchased separately

Y701871	Twin Monitor Adaptor	£75.00
---------	----------------------	--------

D



D. Quick Release Universal Laptop Holder

Y701869		£66.00
---------	--	--------

Cable Management

A. Salerno mini cpu holder

- Ideal for small and thin client CPU's
- Fixes direct to desk top
- Choice of Black, White or Silver

Suitable for Very Small CPUs

		Model	Width Range	Height Range	
CHF1104-BK	Black	T2	40-115mm	205-360mm	£56.00
CHF1104-SV	Silver	T2	40-115mm	205-360mm	£56.00
CHF1104-WH	White	T2	40-115mm	205-360mm	£56.00



A

B. Salerno T1 large cpu holder

- Ideal for older and large CPU's.
- Fixes direct to desk top
- Adjustable width 110 – 230mm; height 300 – 500mm high
- Choice of Black, White or Silver

		Model	Width Range	Height Range	
CHF2208-BK	Black	T1	110-230mm	300-500mm	£66.00
CHF2208-SV	Silver	T1	110-230mm	300-500mm	£66.00
CHF2208-WH	White	T1	110-230mm	300-500mm	£66.00

Desk beam clearance spacer for use with T1, T2, T3

CHSP-BK		£9.00
---------	--	-------



B

C. Salerno T3 universal strap cpu holder

- Ideal for all sizes of CPU.
- Fixes direct to desk top
- Adjustable width 40 – 230mm; height 180 – 500mm high
- CPU can be mounted vertically or horizontally

CHF2504-BK		£38.00
CHFHMK	Horizontal Mounting Kit for use with T3	£22.00



C

D. Vertical cable management

VCS4	Plastic Cable Duct in Black, White or Light Grey	£42.00
------	--	--------



D

E. Horizontal cable management

Cable trays:

- Silver metal, attached to modesty panel
- D70 x H50mm

CTM085	Cable Tray for 1200mm Desk, W850	£59.00
CTM105	Cable Tray for 1400mm Desk, W1050	£62.00
CTM125	Cable Tray for 1600mm Desk, W1250	£75.00
CTM145	Cable Tray for 1800mm Desk, W1450	£82.00



E

Storagewall Module options

Designed and manufactured to save space, save money and give you the most flexible and comprehensive storage system available.

There simply isn't sufficient room here to illustrate the huge range of applications and options, please contact your sales representative to arrange an appointment or call us to arrange a showroom visit.

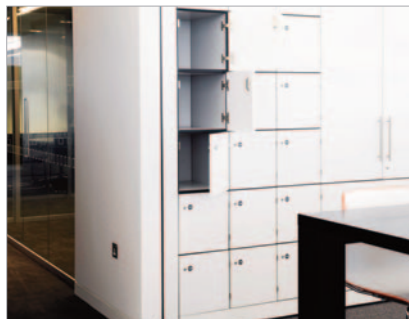

Lockers

The provision of personal storage space is a key objective within today's workplace environment.



Alcove modules

Add a seat or a display module with glass doors and low voltage lighting.



Storagewall

Full height storage wall in MFC to provide maximum storage in any available area.



Tambours

In areas where space is at a premium such as corridors, tambours will overcome access problems.



Media display

Incorporate plasma screens, video-conferencing facilities and other media aids within specialist media modules.



Internal fitments

Choose from shelves, filing frames, letter sorters, drawers to suit your own requirements



Pigeon hole units

Can be combined with cupboards or drawers to save time and maximise space.

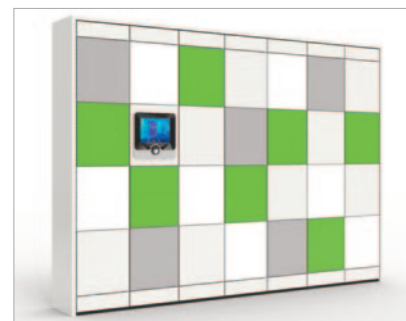

Bespoke colours

A huge range of options available in both woodgrain effects and plain colours, an opportunity to make your storage wall unique.

Suppose you wanted to create an atmosphere of excellence...
 Suppose you like impressive classrooms...
 Suppose there was a place for everything...

Storagewall is the perfect solution!



Storagewall can be used in a wide variety of applications.

See opposite page for Storagewall examples and fitment options.

Page Link - see pages
 Teaching Walls  91-95



Internal fitment options

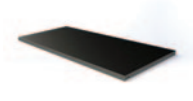

Metal Combi Shelf



Wooden Shelf



Roll-out Filing Frame



Roll-out Storage Drawer



Lateral Filing Frame

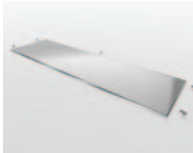

Glass Shelf

Heavy Duty Double
Drawer Inside Storage

Pigeon Hole Unit



LED Shelf Lighting



Pull-out Hanging Rail



LED Coat Rail



Static Coat Hanger



Image Ref. 770200

Design options

To further increase the flexibility of the solution available you also have the ability to specify the cupboard functionality using our diverse range of cupboard designs. For space saving and areas such as corridors where access is a key issue utilise the tambour front or sliding doors, for maximum storage the full height doors 'fit the bill', or where something a bit different is needed why not consider wave doors? Variations include split height doors and direct access filing, with the option of glass display alcoves. To increase versatility incorporate lockers and hot desking pedestals for nomadic working practices.

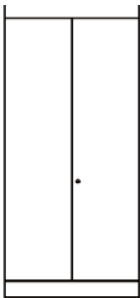
Full height
doorsVertical Tambour
doors

Wave doors

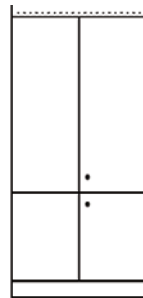

Open fronted

Split height
doorsDoor/drawer
combo

Display alcove



Storagewall

Storagewall can provide up to 60% more storage than conventional storage cupboards – and in the same floor space usage! By using the full height and width of the available area, a storage density of 15.2² metres of storage per metre² of floor space can be achieved.

Consider the ability of storagewall to create an environment that is uncluttered and attractive to work in, functional and efficient to use and is adaptable to the ever changing demands of the modern workplace, and the argument for including it in your interior scheme becomes compelling.

Totally relocatable, able to provide acoustic ratings in line with the best partition systems, and flexible in design – storagewall is a modular storage system that can adapt to any environment.



Storagewall - Internals & Options

Image Ref. 770200

Finish options

In order to make your storage wall truly unique and bespoke to your own environment, consider the almost infinite options available to your external finish.

From a wide range of standard MFC finishes and coloured laminates, through book-matched and suited real wood veneers, and to more exotic finishes such as spray lacquered paint finishes, back painted glass and graphics—let the storagewall be the palette for your imagination!



Wood & colour finishes may not be representative of actual colours - please ask for a sample



Laminates



A

Fast
Track5 Year
WarrantyPhone
For Bulk
Prices

Steel Storage

A. Lugano standard filing cabinet



- 30kg suspension file carrying capacity per drawer
- 5 year guarantee
- Anti-tilt locking mechanism
- 100% drawer extension
- Size: W458 x D620mm
- Drawer depth 440mm
- Ordering less than 2 units may require a carriage charge, please check at time of ordering
- Standard colour Grey

YSLV2M*	2 Drawer - 711mm High	£155.43
YSLV3M*	3 Drawer - 1009mm High	£169.49
YSLV4M*	4 Drawer - 1320mm High	£176.44

Discounts available on quantity orders

B



B. Lugano multidrawer units



- Locking and non-locking
- 5 year guarantee
- Smooth running drawers
- Size: W278 x D408mm
- Ordering less than 2 units may require a carriage charge, please check at time of ordering
- Drawer dimensions H49 x W233 x D364mm
- Available in Goose Grey, Coffee Cream, Light Grey and Black

		Height mm	
YMMR05LK	5 Drawer Locking	355	£142.10
YMMR10LK	10 Drawer Locking	605	£184.50
YMMR15LK	15 Drawer Locking	866	£237.20
YMMR05SD	5 Drawer Non Locking	355	£75.50
YMMR10SD	10 Drawer Non Locking	605	£120.70
YMMR15SD	15 Drawer Non Locking	866	£187.93

* Please state colour required

Steel Storage

A. Lugano premium filing cabinet

- 40kg suspension file carrying capacity per drawer
- 10 year guarantee
- 100% drawer extension
- Size: W458 x D620mm
- Drawer depth 525mm
- Ordering less than 2 units may require a carriage charge, please check at time of ordering
- Colours available as shown below



10 Year
Warranty

Phone
For Bulk
Prices



A

YMIFC2M*	2 Drawer - 711mm High	£170.63
YMIFC3M*	3 Drawer - 1009mm High	£179.81
YMIFC4M*	4 Drawer - 1320mm High	£186.53



Light Grey LG Black BK Graphite GP Goose Grey GG Brown & Beige BG Coffee & Cream CC

B. Lugano coloured filing cabinet

- 40kg suspension file carrying capacity per drawer
- 10 year guarantee
- Anti-tilt locking mechanism
- 100% drawer extension
- Size: W458 x D620mm
- Drawer depth 525mm
- 4 week delivery
- Ordering less than 2 units may require a carriage charge, please check at time of ordering
- Colours available as shown below



10 Year
Warranty

Phone
For Bulk
Prices

4 Week
Delivery



B

Y785000*	2 Drawer Coloured - 711mm High	POA
Y785001*	3 Drawer Coloured - 1009mm High	POA
Y785002*	4 Drawer Coloured - 1320mm High	POA

* Please add colour code



Traffic Purple TP Sienna Orange SO Chlorophyll CH Racing Green RG Blue BL Red RD

5 Year
Warranty

A



Steel Storage

A. Lugano storage cupboard



- Two locking doors with strengthener
- 5 year guarantee
- 5 heights available
- 915mm wide x 458mm deep
- Standard colours as shown below, other colours available to order
- Ordering less than 2 units may require a carriage charge, please check at time of ordering

YMSC1A	690mm High	£174.61
YMSC4A	1020mm High	£180.61
YMSC6A	1650mm High	£224.19
YMSC7A	1830mm High	£221.55
YMSC8A	1950mm High	£286.15
YCAPSP1SD	Plain Shelf, 330mm Hanging	£19.03

Cupboards supplied empty - choose accessories from range on page 366

15 Year
Warranty

B



B. Lugano executive storage cupboard



- Locking doors with full length reinforcements
- Swan neck handle
- 15 year guarantee
- Security bar option
- 1000mm wide x 507mm deep
- Standard colours as shown below, other colours available to order
- Ordering less than 2 units may require a carriage charge, please check at time of ordering

Y785020	1020mm High	£231.31
Y785021	1830mm High	£271.75
Y785022	1950mm High	£333.57

Cupboards supplied empty - choose accessories from range on page 366

Standard Colours

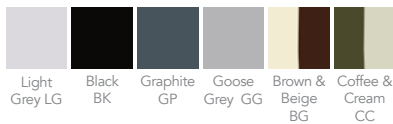

Special Order Colours

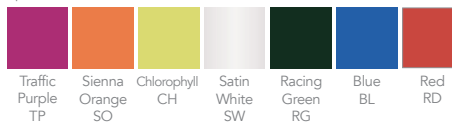

Steel Storage

A. Lugano side tambour cupboard



- Magnetic handle strip
- Smooth running track
- 5 year guarantee
- 5 heights available
- Standard colours as shown on opposite page, other colours available to order. Tambour colours shown below
- 1003mm wide x 507mm deep
- Ordering less than 2 units may require a carriage charge, please check at time of ordering

YM2ESD	690mm High	£307.08
YM4ESD	1016mm High	£329.26
YM9ESD	1320mm High	£356.11
YM6ESD	1651mm High	£379.62
YM7ESD	2000mm High	£392.65
YCAPSP1SD	Plain Shelf, 330mm Hanging	£19.03

Cupboards supplied empty - choose accessories from range on page 366



5 Year
Warranty

A

B. Lugano premium side tambour cupboard



- Smooth track glide system
- 10 year guarantee
- 7 heights available
- 1003mm wide x 507mm deep
- Standard colours as shown on opposite page, other colours available to order. Tambour colours shown below,, other tambour colours available to order (minimum 10 units)
- Ordering less than 2 units may require a carriage charge, please check at time of ordering

YMXST2	690mm High	£386.86
YMXST4	1016mm High	£404.93
YMXST5	1200mm High	£443.07
YMXST9	1320mm High	£506.18
YMXST6	1651mm High	£546.55
YMXST7	2000mm High	£551.99
YMXST8	2210mm High	£626.73
YCAPSP1SD	Plain Shelf, 330mm Hanging	£19.03

Cupboards supplied empty - choose accessories from range on page 366



15 Year
Warranty

B

Tambour Colours

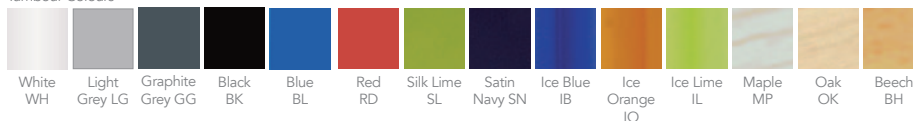



Plain Shelf, 330mm hanging

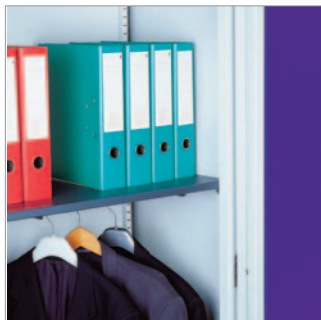

Wardrobe Shelf



Lateral Filing Frame



Roll Out Shelf



Letter Sorter



Roll Out Slotted Drawer / Shelf Dividers



Slotted Shelf / Slotted Shelf Divider



Plain Shelf, 270mm hanging



Roll Out Suspended Filing Frame

Cupboard fittings

With a range of 9 internals, all your storage requirements are covered; and remember all internals can be used in our range of Lugano Side Tambours, Vertical Tambours as well as Open Fronted Cupboards.



- Please note that roll-out items are only recommended in the bottom half of the units
- Remember to specify anti-tilt with roll-out filing

	Lugano & Lugano Premium	Lugano Executive	
Plain Shelf 330mm Hanging	YCAPSP1SD	Y785053	£19.03
Wardrobe Shelf	YCAWSP1	Y785056	£41.77
Lateral Filing Frame	YCALFP1	Y785050	£27.30
Roll Out Shelf	YCARSP1SD	Y785054	£75.67
Letter Sorter	YCALSP1SD	Y785051	£170.15
Roll Out Slotted Drawer	YCADRP1SD	N/A	£112.32
Shelf Dividers for above Pk5	Y700150	N/A	£18.90
Slotted Shelf	YCASSP1SD	Y785055	£34.59
Shelf Dividers for above PK5	YCASDP5SD	N/A	£40.39
Plain Shelf 270mm Hanging	YCAPSF1SD	Y785052	£37.84
Roll out Suspended Filing Frame	YSDCARFP1	Y785057	£125.46

Teacher Cupboards

- Secure and flexible storage solution for large and small item storage
- Ideal for use in classrooms
- Provides two upper storage levels complete with one adjustable shelf
- Choice of three tray sizes 75, 150 and 225mm high. All trays W312 x D427mm
- Reinforced doors with three point locking
- Tray colour options are opaque, yellow, red and blue
- Supplied with polypropylene trays
- Tray options are 12, 18 & 30 units

Tray storage teacher cupboards

Y785100	12	Extra Deep 225mm	Opaque	£783.51
Y785200	12	Extra Deep 225mm	Red	£783.51
Y785300	12	Extra Deep 225mm	Blue	£783.51
Y785400	12	Extra Deep 225mm	Yellow	£783.51

Y785500	18	Deep 150mm	Opaque	£892.13
Y785600	18	Deep 150mm	Red	£892.13
Y785700	18	Deep 150mm	Blue	£892.13
Y785800	18	Deep 150mm	Yellow	£892.13

Y785900	30	Shallow 75mm	Opaque	£972.56
Y786000	30	Shallow 75mm	Red	£972.56
Y786100	30	Shallow 75mm	Blue	£972.56
Y786200	30	Shallow 75mm	Yellow	£972.56

All cupboards H1830 x W1120 x D457mm. Trays and runners are delivered separately from the cupboard and require fitting on site. Trays manufactured from polypropylene, delivered separately.



Page Link - see pages
Metall
storage
units

90-94



All cupboards are supplied with a mid grey carcass.

Standard door colours



Blue

Dark
Grey

Red

Mid Grey

Designed to contain spillages via the leak proof sump, suitable for those substances classified as being harmful or irritant. Supplied with GHS labelling, the primary label is 'Exclamation Mark'.



COSHH cabinets

A. COSHH cabinets

Code	Size (h x w x dmm)	Number of Shelves	Sump Capacity	3 Point Locking	Price
YCOH2001	1830 x 1220 x 457	3	45Ltr	✓	£559.00
YCOH2002	1830 x 915 x 457	3	36Ltr	✓	£462.00
YCOH2003	1220 x 915 x 457	2	36Ltr	✓	£406.00
YCOH2004	1830 x 610 x 457	3	20Ltr	✓	£394.00
YCOH2005	1000 x 915 x 457	1	30Ltr	✓	£322.00
YCOH2006	910 x 457 x 457	1	18Ltr		£245.00
YCOH2007	710 x 915 x 457	1	30Ltr	✓	£289.00

B. mini COSHH cabinets

Code	Size (h x w x dmm)	Number of Shelves	Sump Capacity	3 Point Locking	Price
YCOH2008	610 x 915 x 381	1	15Ltr	✓	£277.00
YCOH2009	760 x 457 x 457	1	10Ltr		£239.00
YCOH2010	710 x 457 x 305	1	10Ltr		£227.00
YCOH2011	610 x 457 x 457	1	10Ltr		£230.00
YCOH2012	457 x 457 x 305	1	5Ltr		£218.00

C. COSHH stackable cabinet

Code	Size (h x w x dmm)	Number of Shelves	Sump Capacity	3 Point Locking	Price
YCOH2013	710 x 915 x 457	1	30Ltr	✓	£336.00

Dangerous Substance Cabinets

Robust metal construction cabinets with a leak proof sump to contain any spillages. Supplied with GHS labelling, the primary label is 'Flammable'.

A. Dangerous substance cabinets

Code	Size (h x w x dmm)	Number of Shelves	Sump Capacity	3 Point Locking	Price
YDSC1001	1830 x 1220 x 457	3	45Ltr	✓	£522.00
YDSC1002	1830 x 915 x 457	3	36Ltr	✓	£433.00
YDSC1003	1830 x 610 x 457	3	20Ltr	✓	£368.00
YDSC1004	1525 x 915 x 457	2	36Ltr	✓	£407.00
YDSC1005	1220 x 915 x 457	2	36Ltr	✓	£381.00
YDSC1006	1000 x 915 x 457	1	30Ltr	✓	£300.00
YDSC1007	910 x 457 x 457	1	18Ltr	✓	£226.00
YDSC1008	710 x 915 x 457	1	30Ltr	✓	£271.00



B. Mini dangerous substance cabinets

Code	Size (h x w x dmm)	Number of Shelves	Sump Capacity	3 Point Locking	Price
YDSC1009	610 x 915 x 457	1	30Ltr	✓	£262.00
YDSC1010	610 x 915 x 381	1	15Ltr	✓	£258.00
YDSC1011	780 x 457 x 457	1	10Ltr	✓	£223.00
YDSC1012	710 x 457 x 305	1	10Ltr	✓	£213.00
YDSC1013	710 x 355 x 305	1	5Ltr	✓	£206.00
YDSC1014	610 x 457 x 457	1	10Ltr	✓	£215.00
YDSC1015	457 x 457 x 305	1	5Ltr	✓	£204.00



C. Dangerous substance wall cabinets

Code	Size (h x w x dmm)	Number of Shelves	Sump Capacity	3 Point Locking	Price
YDSC1016	610 x 915 x 381	1	15Ltr	✓	£263.00
YDSC1017	480 x 915 x 457	1	20Ltr	✓	£253.00

D. Dangerous substance stackable cabinets

Code	Size (h x w x dmm)	Number of Shelves	Sump Capacity	3 Point Locking	Price
YDSC1018	710 x 915 x 457	1	30Ltr	✓	£311.00
YDSC1019	610 x 915 x 457	1	30Ltr	✓	£302.00



FREE Pen Tray and 2 drawer dividers with every pedestal

Steel Storage

Anzio CUBE Steel Pedestals



White Pedestals, Standard and Narrow Widths

- Super strong, smart option for the modern office
- Range includes narrow (300mm) width – ideal for small desks
- Free drawer dividers and pen tray with every pedestal
- Available on Express 7 day delivery
- 4 locking, hidden castors (supplied, fitted)
- 5 year guarantee
- Compact 500mm depth – doesn't clash with large cable trays
- Main colour used inside drawers
- Central locking – free master key with large orders
- Anti-tilt mechanism
- Soft close drawer runners

Page Link - see pages
For
wooden
pedestals

317,336,342

3 Drawer,
Silver Pedestal

All Anzio CUBE Steel Pedestals Come With Free Drawer Dividers & Pen Tray

A



B



A. Steel mobile pedestal

- 2 Personal drawers 1 File drawer
- 410 x 500 x H597mm

YPMS4521-WH	White	£270.07
YPMS4521-BK	Black	£270.07

B. Steel narrow mobile pedestal

- 2 Personal drawers 1 File drawer
- 300 x 500 x H597mm

YPMS3521-SV	Silver	£267.33
YPMS3521-WH	White	£267.33
YPMS3521-BK	Black	£267.33

Safes

A. Key deposit safes

- Ideal for schools, office blocks, garages, homes
- Fitted with advanced electronic locking system, including anti-tamper or bounce solenoid locking system, and a key override facility
- Key deposit slot allows keys to be deposited without the need to open the safe
- Deposit slot 55 x 35 x 15mm
- Prepared for wall mounting, fixing bolts supplied
- Supplied with a selection of coloured key rings

Code	External Size H x W x Dmm	Deposit slot Internal Size H x W x Dmm	Keys Capacity	
Y787600	280 x 300 x 100	275 x 295 x 80	30 keys	£104.71
Y787700	360 x 300 x 100	350 x 275 x 80	48 keys	£109.37
Y787800	660 x 430 x 130	655 x 425 x 110	144 keys	£156.71



Key Deposit Slot



Y787600



Y787700



Y787800

A

B. Home & office safes

- Recommended for overnight cash cover of £1000 cash or £10,000 valuables
- Twin live locking bolts and concealed internal hinges for increased security
- Electronic locking with high security anti-tamper or bounce solenoid locking system
- Key over ride system. Supplied with 2 keys
- LED internal light
- Prepared for fixing to walls or concrete floors. Fixings supplied
- Scratch resistant metallic graphite paint
- Item 780600 stores laptop up to 430mm wide

Code	External size H x W x Dmm	Internal Size H x W x Dmm	Capacity L	No. Shelves	
Y787100	200 x 310 x 200	195 x 305 x 160	10	0	£81.00
Y787200	250 x 350 x 250	240 x 340 x 210	17	1	£93.92
Y787300	250 x 450 x 365	240 x 440 x 325	34	1	£135.54
Y787400	500 x 350 x 310	495 x 345 x 300	51	1	£136.43
Y787500	560 x 370 x 445	556 x 366 x 435	88	1	£202.63



Y787100



Y787200



Y787300



Y787400



Y787500

B



LED Internal Light

Lifetime
WarrantyFree After-Fire
Replacement

A



B



Y1181

Y1183

Y1182

C

Suitable for
exam papers

Y2001

Y2002

Safes

A. Electronic fire safe

- Modern, compact fire and security safe
- 60 minutes fire protection for paper and digital media
- £2,000 cash and £20,000 valuable rating
- Fitted with user friendly, high security electronic lock
- Ultra-lightweight, 4 internal key hooks & pull out drawer
- Ready prepared for floor fixing (bolts supplied)
- Also available with key locking

	Dimensions Size H x W x Dmm	Capacity Litres	Weight Kg	
YFS1E	360 x 410 x 365	19	28	£276.20
YFS2E	410 x 350 x 430	25	34	£359.53
YFS3E	515 x 400 x 440	36	56	
	Underdesk			£398.12

B. Security safe

- Fitted with high security double bitted VDS Class 1 key lock
- £4,000 cash and £40,000 valuable rating
- Fixing bolts supplied
- Manufacturer's insurance rating for cash and jewellery
- Also available with electronic locking, ask for details

	Internal/External Size H x W x Dmm	Capacity Litres	Weight Kg	
Y1181	140 x 270 x 190	7	15	
	220 x 350 x 300			£247.11
Y1182	270 x 365 x 240	24	25	
	350 x 450 x 350			£306.61
Y1183	470 x 365 x 240	32	37	
(underdesk)	550 x 450 x 350			£470.92

C. Fire resistant media safe

- A compact data safe for convenient storage of important disks, tapes and electronic records
- £1,500 cash and £15,000 valuable rating
- Magnetic media fully protected
- Y2001: 60 minute fire resistance for data and digital media
- Y2002: 90 minute fire resistance for data and digital media

	Internal/External Size H x W x Dmm	Capacity Litres	Weight Kg	
Y2001	240 x 150 x 195	7	43	
	420 x 350 x 430			£524.55
Y2002	380 x 245 x 195	18	93	
(underdesk)	600 x 470 x 470			£1016.42

Safes

A. Fire resistant cupboards

- High security cupboards with double walled construction
- Perfect for storing sensitive exam papers
- Fire resistant to 30 minutes
- 3 way locking system
- Supplied with height adjustable shelves
- Standard colour grey (RAL7035)
- Internal fittings available at extra cost. Please call for details.
- Electronic keypad locking system

Code	Internal/External Size H x W x Dmm	Capacity Litres	Weight Kg	Shelves	
YFRC1	1080 x 505 x 410	224	66	2	
	1225 x 600 x 520				£1249.29
YFRC2	1080 x 815 x 410	359	106	4	
	1225 x 930 x 520				£1686.07
YFRC3	1810 x 815 x 410	615	152	4	
	1850 x 1250 x 520				£2064.92

All models are available with an electronic keypad locking system as shown below.

YFRC1L	1080 x 505 x 410	224	66	2	
	1225 x 600 x 520				£1391.63
YFRC2L	1080 x 815 x 410	354	106	4	
	1225 x 930 x 520				£1824.12
YFRC3L	1810 x 815 x 410	611	152	4	
	1850 x 1250 x 520				£2210.27

B. Double secure filing cabinets

- Robust filing cabinets with locking bar system giving high security storage at a budget price
- 100% drawer extension
- 10 year guarantee
- Available in Goose Grey, Coffee Cream or Black

Y11325	2 Drawer	H711 x W458 x D620	£226.13
Y11326	3 Drawer	H1009 x W458 x D620	£250.92
Y11327	4 Drawer	H1320 x W458 x D620	£248.79

C. Fire resistant filing cabinets

- Light grey filing cabinets
- Fire resistant for 90 minutes paper, 60 minutes digital media
- Individual fire protection for all drawers
- Fire and impact tested 9.1metres for resistance to the impact of falling through the burning floors of a building
- Available with electronic keypad & fingerprint locking systems

Y2244	H1405 x 530 x 675mm	4 Drawer	266kg	£1890.51
Y2242	H720 x 530 x 675mm	2 Drawer	140kg	£1339.90

D. Double secure filing cupboard

- Robust filing cupboard with locking bar system giving high security storage at a budget price
- 2 locking doors
- 5 year guarantee
- Available in Goose Grey, Coffee Cream or Black

Y785030	H1830 x W915 x D458mm	£353.20
---------	-----------------------	---------



Available with fingerprint locking systems



A

Includes delivery and position in place

Page Link - see pages

For exam tables...

44-45



B



C



D



Delivery of security cupboards is free of charge to a ground floor location with no more than one step involved. Other delivery locations require a site survey & quotation.

Suitable for exam papers

Welcome

Please orientate yourself
with the campus and
surrounding area

Consult the receptionist
if any specific problem is
not covered here or by
your student handbook



Are you putting on your best display?

Our range of display and notice boards will really get the message across and showcase your student's work to the best advantage.

Presentation & Display

Whiteboards	376-378
Glass Boards	379
Mobile Whiteboards	380-381
Flipchart Easels	382-383
Projection Screens	384
Interactive Flat Panel Display Boards	385
Noticeboards	386-393
Exterior Showcases	394-395
Folding Display Systems	396-399
Display Showcases	400-401
Lecterns	402
AV Cabinets	403

Presentation & Display

Having a display that looks effective and attractive can sometimes be difficult to achieve. Our large range of high quality display products will assist you in presenting your student's work to look its best as well as adding a feature to your classroom or school.

Whether you require just one notice board or a complete display system we can fulfill your requirements to your best advantage. If there is something you are looking for and can't find it in our catalogue please give us a call; we are sure we will be able to source it for you.



Best Seller

A



B



Premium Quality Brands

C



Premium Quality Brands

Whiteboards

A. Plain & gridded non-magnetic whiteboards

Double sided whiteboard with one side plain ultrasmooth surface and gridded surface on the other. The gridded side has a feint 20mm square grid that assists the presenter, but is unseen by the audience. Aluminium framed & supplied with pen tray and concealed through-the-corner wall fixings. For use with drywipe pens. Mounted landscape or portrait.

YSMDW152	W600 x H450mm	each	£24.90
YSMDW32	W600 x H900mm	each	£35.40
YSMDW43	W900 x H1200mm	each	£53.40
YSMDW44	W1200 x H1200mm	each	£63.50
YSMDW54	W1500 x H1200mm	each	£80.55
YSMDW64	W1800 x H1200mm	each	£102.55
YSMDW84	W2400 x H1200mm	each	£135.50

B. Magnetic whiteboards

This economically priced whiteboard has a revolutionary new surface which is ultra smooth to improve erasability, with the added advantage of accepting magnets

- Aluminium framed plain white drywipe surface
- Supplied with concealed wall fixings and pen tray
- All boards 180cm wide and larger have extra central fixings at top and bottom for additional safety and stability

YSMDWM152	W450 x H600mm	each	£23.85
YSMDWM32	W600 x H900mm	each	£32.55
YSMDWM43	W900 x H1200mm	each	£50.25
YSMDWM44	W1200 x H1200mm	each	£64.20
YSMDWM54	W1500 x H1200mm	each	£84.15
YSMDWM64	W1800 x H1200mm	each	£101.35
YSMDWM84	W2400 x H1200mm	each	£119.25

C. Vitreous enamel steel magnetic whiteboards

- Vitreous Enamel Steel with 25 year surface guarantee
- Aluminium framed whiteboards with concealed corner fixings and pen tray
- Surface accept magnets
- All boards 180cm wide and larger have extra central fixings at top and bottom for additional safety and stability

YVDW152	W450 x H600mm	each	£35.30
YVDW32	W900 x H600mm	each	£51.80
YVDW43	W1200 x H900mm	each	£85.80
YVDW44	W1200 x H1200mm	each	£110.85
YVDW54	W1500 x H1200mm	each	£136.35
YVDW64	W1800 x H1200mm	each	£160.60
YVDW84	W2400 x H1200mm	each	£209.45

Whiteboards

A. Coloured edge frameless whiteboards

- The tough ABS colour edging adds a modern accent to an everyday product
- Frameless whiteboard with a coloured edge
- Mounts flush to the wall
- Choice of 6 bright colours with matching caps
- Ideal for mounting side by side
- Please note: these boards are frameless so sizes shown are nominal

Y31060**	W900 x H600mm	each	£42.90
Y31062**	W1200 x H900mm	each	£61.05
Y31064**	W1200 x H1200mm	each	£81.75
Y31066**	W1500 x H1200mm	each	£101.85
Y31068**	W1800 x H1200mm	each	£115.45
Y31070**	W2400 x H1200mm	each	£138.35

**Please specify colour when ordering

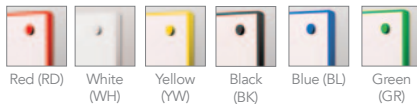

Red (RD) White (WH) Yellow (YW) Black (BK) Blue (BL) Green (GR)

B. Light oak effect premium aluminium frame whiteboard

Stunning light oak wood effect aluminium frame with a traditional yet contemporary finish without the maintenance of real wood.

- Coated Steel Surface accepts magnets
- Attractive contoured frame design
- Concealed corner fixings

Y801650	W900 x H600mm	each	£74.75
Y801652	W1200 x H900mm	each	£103.65
Y801646	W1200 x H1200mm	each	£132.10
Y801648	W1500 x H1200mm	each	£170.45
Y801654	W1800 x H1200mm	each	£184.35
Y801656	W2400 x H1200mm	each	£212.80

C. Coloured edge premium aluminium frame whiteboard

- Concealed corner fixings
- Coated steel surface accepts magnets
- Available in 4 different colours

Y801150	W900 x H600mm	each	£86.70
Y801152	W1200 x H900mm	each	£117.55
Y801154	W1200 x H1200mm	each	£141.35
Y801156	W1500 x H1200mm	each	£184.15
Y801158	W1800 x H1200mm	each	£196.50
Y801160	W2400 x H1200mm	each	£226.25

**Please specify colour when ordering



Blue (BL) Green (GR) Red (RD) White (WH)



A



B



C

Whiteboards

A



A. Writewall whiteboard walling

- Create a continuous drywipe whiteboard wall
- Frameless design
- 6 standard sizes to choose from to create the best option
- Simple through the board fixing
- ABS edge, white caps mask fixings
- Double sided, plain on one side, and faint square grid on the other
- Bespoke sizes available - please enquire

Y31072	W876 x H578mm	each	£61.30
Y31074	W1176 x H876mm	each	£87.20
Y31076	W1176 x H1176mm	each	£118.20
Y31078	W1476 x H1176mm	each	£145.50
Y31080	W1779 x H1176mm	each	£164.95
Y31082	W2379 x H1176mm	each	£197.65



Page Link - see pages

For
Conference
Seating



Page Link - see pages

For
Meeting
Tables



B



New
Product

B. Frameless magnetic whiteboard

An innovative product which allows you to create a continuous dry wipe magnetic surface by butting the boards together.

- Available in 2 different sizes
- Mounts flush to the wall with a magnetic mounting system
- Supplied with a fixing template, and fixings for attachment to a solid wall
- Can be fixed landscape or portrait

Y802550	1150 x 750mm	each	£150.75
Y802555	1500 x 1000mm	each	£227.70

Glass Boards

A. White magnetic glass writing boards

- The ultimate in contemporary drywipe presentation
- Magnetic glass drywipe board
- 4mm toughened safety glass, needs super strength magnets
- Chrome mounts which float the board away from the wall
- All fixings included
- Only available in White

Y31091	W600 x H900mm	each	£115.55
Y31092	W650 x H1000mm	each	£138.95
Y31093	W1500 x H1000mm	each	£250.75
Y31094	W900 x H1200mm	each	£180.40
Y31095	W1200 x H1200mm	each	£241.45
Y31096	W1800 x H1200mm	each	£315.35
Y31097	W2400 x H1200mm	each	£437.50
Y800120	Glass Pen Tray - optional extra	each	£18.00
Y800122	25mm Super Strength Magnets	pk 2	£20.00
Y800124	Glass Pens	pk 5	£19.75



A



B. Coloured glass information boards

- Display your messages or menus in style
- 6 standard colour range, 4 vibrant colour range
- Range of attractive glass dry-wipe boards
- 4mm toughened glass with a steel back
- Accepts super strength magnets
- Board stands proud of the wall on special fixings

Y31098**	W500 x H500mm	each	£74.55
Y31099**	W450 x H600mm	each	£78.10

** Please specify board colour when ordering

Standard colours

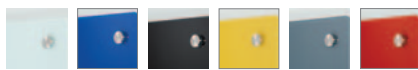

White (WH) Blue (BL) Black (BK) Yellow (YW) Grey (GY) Red (RD)

Vibrant colours

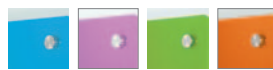

Sky Blue (SB) Violet (V) Lime Green (LG) Orange (OR)

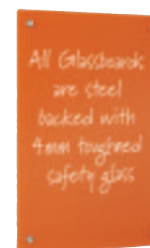

B

C. Coloured magnetic glass writing boards

- 4mm toughened safety glass
- 14 board colours to choose from
- 6 different size options
- Contemporary chrome fixings
- Suitable for portrait or landscape use
- Can be fitted side-by-side to create a seamless large writing area

Y802520**	W900 x H600mm	each	£234.50
Y802521**	W1000 x H650mm	each	£246.15
Y802522**	W1200 x H900mm	each	£283.95
Y802523**	W1200 x H1200mm	each	£366.95
Y802524**	W1500 x H1200mm	each	£438.35
Y802525**	W1800 x H1200mm	each	£498.00

** Please specify board colour when ordering



Black Blue Cream Gold Green Grey Lilac Lime Orange Purple Red Sky Turquoise Yellow



C

Customised boards available - Please ask for price details

Mobile Whiteboards

A. Height adjustable mobile whiteboards

Double sided mobile drywipe whiteboard

- White anodised aluminium frame with locking castors
- Height adjustable panels that can be mounted portrait or landscape
- Double sided whiteboard with one side plain and the reverse with a feint grid

Y801280	W900 x H1200mm	each	£176.55
Y801282	W1200 x H1200mm	each	£188.60
Y801284	W1500 x H1200mm	each	£209.25
Y801286	W1800 x H1200mm	each	£223.45



A

Page Link - see pages

For Meeting Tables 



B

B. Combi mobile noticeboards

- Freestanding board with whiteboard one side, noticeboard on reverse
- A versatile mobile board offering both pinboard and whiteboard applications in one product
- Available in two popular sizes and mounted on a stable powder coated steel frame, with four castors two of which are lockable
- A1 flip pad clamp on all whiteboard surfaces
- W700 x H1200mm available in grey or blue pinboard

DUONB127	W700 x H1200mm, Grey	each	£121.50
Y802000	W700 x H1200mm, Blue	each	£121.50
DUONB110	W1000 x H1000mm, Grey	each	£134.60

Mobile Whiteboards

A. Standard revolving whiteboards

- Double sided whiteboard that can pivot on its horizontal axis
- Enables both sides to be used, or the surface angled towards the audience
- Available with coated steel writing surface that has the advantage of accepting magnets, or non-magnetic surface that is one side plain, one side gridded.
- Sturdy steel frame has four castors, 2 locking
- Steel cross bars aid rigidity and house a full length pen tray

Non Magnetic

YEREV912	W1200 x H900mm	each	£128.35
YEREV129	W900 x H1200mm	each	£132.80
YEREV1212	W1200 x H1200mm	each	£144.90
YEREV1215	W1500 x H1200mm	each	£167.85
YEREV1218	W1800 x H1200mm	each	£189.35

Magnetic

YEREVM912	W1200 x H900mm	each	£164.05
YEREVM129	W900 x H1200mm	each	£168.00
YEREVM1212	W1200 x H1200mm	each	£193.75
YEREVM1215	W1500 x H1200mm	each	£222.85
YEREVM1218	W1800 x H1200mm	each	£246.55

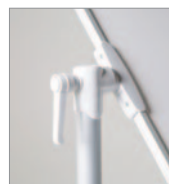

A



H1200 x W900mm

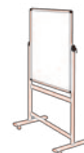

H900 x W1200mm

H1200 x
W1200mmH1500 x
W1200mmH1800 x
W1200mm

B. Premium revolving whiteboards

- Versatile mobile whiteboard with dual action pivoting board
- Double sided whiteboard that can pivot on either its horizontal or vertical axis, enabling both sides to be used, or the surface angled towards the audience
- Available with coated steel writing surface that has the advantage of accepting magnets, or non-magnetic surface that is one side plain, one side gridded

Non Magnetic

YREV912	W1200 x H900mm	each	£155.60
YREV129	W900 x H1200mm	each	£158.55
YREV1212	W1200 x H1200mm	each	£169.55
YREV1512	W1500 x H1200mm	each	£195.20
YREV1812	W1800 x H1200mm	each	£219.20

Magnetic

YREVM912	W1200 x H900mm	each	£197.05
YREVM129	W900 x H1200mm	each	£200.60
YREVM1212	W1200 x H1200mm	each	£220.50
YREVM1512	W1500 x H1200mm	each	£253.70
YREVM1812	W1800 x H1200mm	each	£276.75



B



H1200 x W900mm



H900 x W1200mm

H1200 x
W1200mmH1500 x
W1200mmH1800 x
W1200mm

A



Flipchart Easels

A. Ultimate loopleg flipchart easel (coloured frames)

- Loopleg design creates very steady base with footbar
- Good stability when writing
- Double sized magnetic whiteboard, fully height adjustable
- Suitable for A1 standard 2 hole drilled pads
- Board size W650 x H860mm
- Max height 1720mm
- Optional carry bag

Y31001**	Flipchart Easel	each	£87.15
Y31067	Optional Carry Bag	each	£32.00

** Please specify colour when ordering

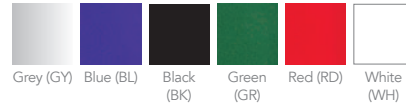

B



B. Ultimate mobile flipchart easel (coloured frames)

- Heavy duty mobile frame
- Magnetic whiteboard
- Height adjustable column
- Round tubular steel base
- Board size W680 x H1000mm
- Max height 1900mm

Y31003**	Mobile Easel	each	£162.95
----------	--------------	------	---------

** Please specify colour when ordering

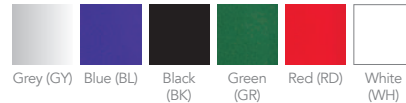

Flipchart Easels

A. Harrier flipchart easel

Economy tripod easel with class beating features

- Rear leg tie bar for extra stability and durability
- Telescopic legs for simple height adjustment
- Magnetic drywipe surface
- Available in Black or White frame
- Board size 1000 x 680mm
- Max height 1850mm

Y800130	Harrier Flipchart Easel - White	£85.15
Y800132	Harrier Flipchart Easel - Black	£85.15



A

B. Eagle mobile flipchart easel

Mobile easel mounted on five star base with locking castors

- Magnetic whiteboard
- Height adjustable
- Two side arms supplied as standard for hanging completed sheets
- Full width pen tray
- Board size 1000 x 680mm
- Max height 1820mm

Y800140	Mobile Flipchart Easel Grey	£143.60
Y800142	Mobile Flipchart Easel Blue	£143.60



B

Projection Screens

A. Portable projection screen

- Fully height adjustable
- Heavy duty tripod base
- Integral carry handle
- 5 different size viewing areas
- Plain matt white borderless surface or matt white projection surface with black borders
- Built-in 'keystone' correction



Borderless

	Overall Size	
Y801100	W1250 x H1250mm	£68.65
Y801110	W1500 x H1500mm	£82.50
Y801120	W1800 x H1800mm	£88.60
Y801130	W2000 x H2000mm	£122.40
Y801140	W2400 x H2400mm	£165.90

With Borders

Y801105	W1250 x H1250mm	£77.70
Y801115	W1500 x H1500mm	£97.65
Y801125	W1800 x H1800mm	£122.65
Y801135	W2000 x H2000mm	£139.85
Y801145	W2400 x H2400mm	£203.25

B. Manual wall-mounted projection screen

- Popular manual pull-down screen
- New slow safety retract mechanism
- Good quality matt white woven cloth
- Easy to mount to wall or ceiling
- Available in 5 different size viewing areas
- Plain matt white borderless surface or matt white projection surface with black borders
- Wider choice of manual and electric projection screens available - please ask for details



Borderless

	Overall Size	
Y801200	W1250 x H1250mm	£73.90
Y801210	W1500 x H1500mm	£77.90
Y801220	W1800 x H1800mm	£87.55
Y801230	W2000 x H2000mm	£108.35
Y801240	W2400 x H2400mm	£197.80

With Borders

Y801215	W1500 x H1500mm	£87.50
Y801225	W1800 x H1800mm	£101.40
Y801235	W2000 x H2000mm	£118.65
Y801245	W2400 x H2400mm	£221.95



PLEASE CONTACT US
FOR MORE
INFORMATION

FREE DEMONSTRATIONS
AVAILABLE



Interactive Flat Panel Display Boards

Award-winning interactive displays & lesson delivery software for education

Viewsonic | Vestel | Promethean | Benq | Smart | Clevertouch

These interactive display boards offer a range of education technology solutions that are built for collaboration, ease of use, and flexibility in a Google technology ecosystem.

All the Essentials, All-In-One, and Value-Focused

The value-focused interactive displays are designed to provide teachers with everything they need straight out of the box. Internet-ready and preloaded with a whole range of teaching tools. They are the long-term, reliable solution for schools looking to replace outdated whiteboard systems with an easy-to-use and highly capable interactive display.

- These interactive display boards include classroom essential apps and a variety of teaching tools – all available at the touch of a button
- Use the infinite canvas on the highly intuitive whiteboard app to instantly supplement lessons.
- Draw, highlight, and annotate over any content from any source
- Quickly screen capture content, crop, and open it within the whiteboard app for further discussion
- Add excitement to any lesson or activity with the customisable apps

A



Felt colours:

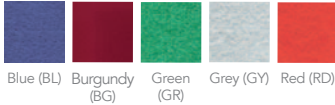

Blue (BL) Burgundy (BG) Green (GR)
Grey (GY) Red (RD)



B

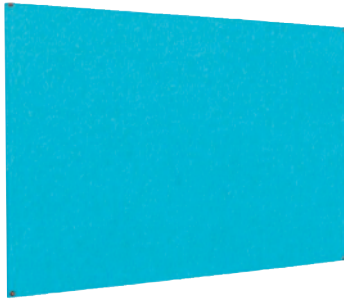

Fabric colours:



Apple Green (AG) Cyan (CY) Magenta (MG)
Lilac (LL) Orange (OR) Purple (PR)

Ideal for escape routes/corridors

C

Acoustic Properties

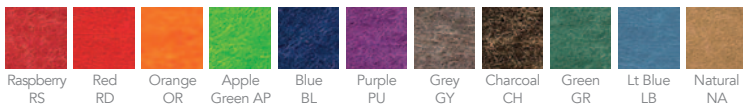
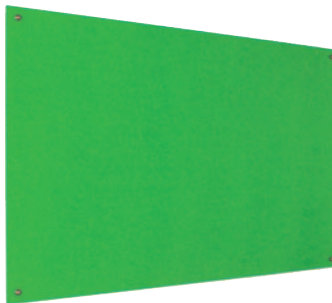

Raspberry (RS) Red (RD) Orange (OR) Apple Green (AP) Blue (BL) Purple (PU) Grey (GY) Charcoal (CH) Green (GR) Lt Blue (LB) Natural (NA)

Unframed Noticeboards

A. Unframed noticeboards

This superior frameless pinboard is made from a high quality board and felt to give a durable and effective product.

- Can be mounted landscape or portrait
- Mounts through the board fixings supplied
- Available in Blue (BL), Burgundy (BG), Green (GR), Red (RD), Grey (GY)
- Bespoke sizes available for large quantity enquiries
- 1500 x 1200mm and larger are supplied in 2 parts

YUNB9060**	W900 x H600mm	each	£26.05
YUNB129**	W1200 x H900mm	each	£35.15
YUNB1212**	W1200 x H1200mm	each	£39.05
YUNB1512**	W1500 x H1200mm	each	£48.75
YUNB1812**	W1800 x H1200mm	each	£53.90
YUNB2412**	W2400 x H1200mm	each	£65.00

** Please specify colour when ordering

B. Colourtone vibrant unframed noticeboards

Simple yet effective style noticeboards to brighten up areas of any establishment.

- Can be mounted landscape or portrait
- Frameless design
- Available in 6 vibrant colours
- 3 largest sizes are supplied in 2 parts

Y801900**	W900 x H600mm	each	£33.70
Y801904**	W1200 x H900mm	each	£45.00
Y801905**	W1200 x H1200mm	each	£52.70
Y801907**	W1500 x H1200mm	each	£62.65
Y801909**	W1800 x H1200mm	each	£80.10
Y801911**	W2400 x H1200mm	each	£82.00

** Please specify colour when ordering

C. Unframed EcoColour® noticeboards

A fantastic range of recycled noticeboards that are not only fire resistant but also have acoustic properties. These boards are made from recycled plastic and in the production of the 1200 x 900mm option there are typically 33 x 25g plastic bottles

- Noticeboard is classified a 'B' according to BS EN13501-1
- Made from recycled materials
- Acoustic properties up to NRC 0.8
- Self- coloured pinnable core
- Available in 11 different colours

Y801500**	W900 x H600mm	each	£32.15
Y801502**	W1200 x H900mm	each	£53.20
Y801504**	W1200 x H1200mm	each	£69.30
Y801506**	W1500 x H1200mm	each	£84.05
Y801508**	W1800 x H1200mm	each	£102.30
Y801510**	W2400 x H1200mm	each	£131.75

** Please specify colour when ordering

Framed Noticeboards

A. Aluminium framed noticeboards

Made in the UK to the highest standards.

- Felt accepts hook & loop fasteners as well as pins
- Colour fast to BS1006
- Available in 5 standard felt colours - Blue (BL), Burgundy (BG), Red (RD), Green (GR), Grey (GY) or traditional cork (CK)
- Flush fix corners conceal wall fixings (supplied)

YNBS64**	W600 x H450mm	each	£25.60
YNBS96**	W900 x H600mm	each	£27.05
YNBS129**	W1200 x H900mm	each	£37.20
YNBS1212**	W1200 x H1200mm	each	£46.45
YNBS1512**	W1200 x H1500mm	each	£56.55
YNBS1812**	W1200 x H1800mm	each	£70.15
YNBS2412**	W1200 x H2400mm	each	£89.60

** Please specify colour when ordering

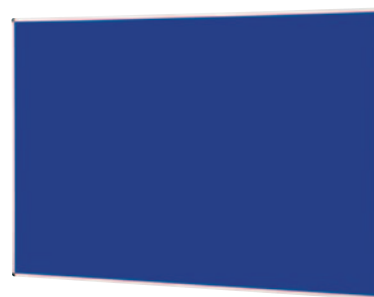

Felt colours:

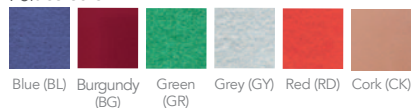

B. Colourtone vibrant noticeboards

- Colourtone range features 6 vibrant and contemporary colours that add a modern accent to an everyday product.
- New range of bright contemporary coloured fabric finishes
- Fabric accepts Velcro as well as pins
- Aluminium frames
- Flush fix corners conceal wall fixings
- 3 smaller size options available - please enquire

Y31000**	W900 x H600mm	each	£37.00
Y31002**	W1200 x H900mm	each	£55.45
Y31005A**	W1200 x H1200mm	each	£65.40
Y31007A**	W1500 x H1200mm	each	£84.70
Y31008**	W1800 x H1200mm	each	£104.90
Y31011A**	W2400 x H1200mm	each	£134.45

** Please specify colour when ordering

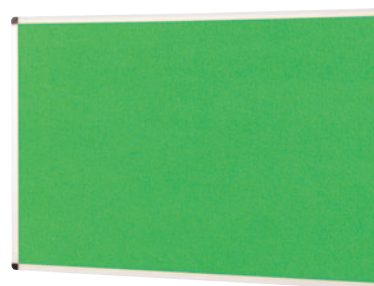

Fabric colours:



C. Eco-friendly noticeboards

Ever popular range offering an environmental choice at an economical price and made in the UK

- Almost entirely constructed from timber industry bi-products and recycled materials
- Attractive contoured 35mm wide frame is available in a choice of light oak, or aluminium effect finishes
- Available in 5 felt colours: Blue (BL), Burgundy (BG), Green (GR), Grey (GY), Red (RD) or Traditional Cork (CK)
- Felt accept both pins and Velcro®, cork option is pinnable
- Boards can be mounted portrait or landscape with concealed fixings provided

YECF96**	W900 x H600mm	each	£32.90
YECF129**	W1200 x H900mm	each	£48.10
YECF1212**	W1200 x H1200mm	each	£55.05
YECF1512**	W1500 x H1200mm	each	£83.40
YECF1812**	W1800 x H1200mm	each	£88.30
YECF2412**	W2400 x H1200mm	each	£106.20

** Please specify colour of material and frame when ordering



Felt colours:

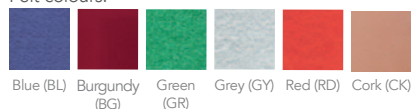

Frame options

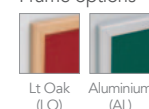

A



B



C

A



Frame colours

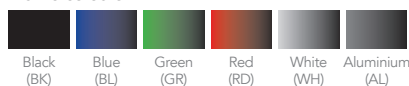

Fabric colours

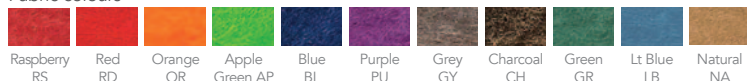

Ideal for escape
routes/corridors

B

Acoustic
Properties

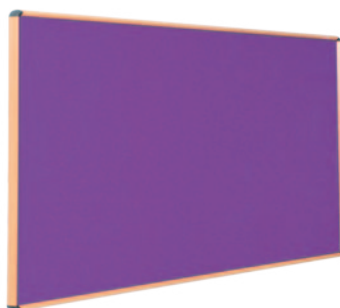

Fabric colours

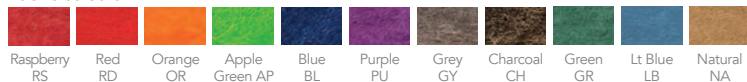

C



See page 390 for 18 loop
nylon colour options

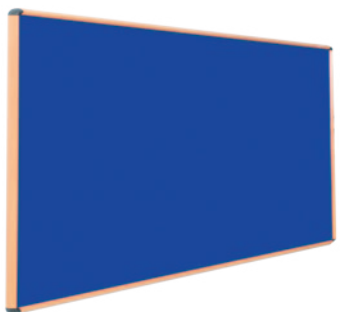

Framed Noticeboards

A. Premium aluminium frame EcoColour® noticeboards

An aluminium frame noticeboard with a distinctive contemporary stylish frame. The increasingly popular EcoColour® material meets the relevant British Fire Safety Standards, and is perfect for use corridors of public buildings.

- Noticeboard is classified a 'B' according to BS EN13501-1
- Available in Aluminium finish frame and 5 different colours
- Can be mounted portrait or landscape
- Self-coloured pinnable core
- Available in 11 different colours

		Aluminium Frame	Coloured Frame
Y820530**	W900 x H600mm	£62.85	£81.90
Y820531**	W1200 x H900mm	£91.95	£113.15
Y820532**	W1200 x H1200mm	£112.50	£134.40
Y820533**	W1500 x H1200mm	£133.65	£158.55
Y820534**	W1800 x H1200mm	£160.30	£183.30
Y820535**	W2400 x H1200mm	£194.05	£218.15

** Please specify colour when ordering

B. Light oak effect premium aluminium frame EcoColour® noticeboard

A range of boards made from the EcoColour® recycled material with a stunning light oak effect aluminium frame. Our popular EcoColour® material meets the relevant British Fire Safety Standards, and is fast becoming the preferred choice for fire resistant noticeboards in the UK.

- Can be mounted portrait or landscape
- Acoustic properties up to NRC 0.8
- Self-coloured pinnable core available in 11 colours
- Noticeboard is classified a 'B' according to BS EN13501-1

Y801560**	W900 x H600mm	£68.80
Y801562**	W1200 x H900mm	£97.90
Y801564**	W1200 x H1200mm	£117.35
Y801566**	W1500 x H1200mm	£144.25
Y801567**	W1800 x H1200mm	£174.65
Y801568**	W2400 x H1200mm	£204.40

** Please specify colour when ordering

C. Light oak effect premium aluminium frame noticeboard

Stunning light oak wood effect aluminium frame with a traditional yet contemporary finish without the maintenance of real wood.

- Attractive contoured frame design
- Available in loop nylon fabric with 17 colour options
- Use with pins or Velcro
- Concealed corner fixings

Y801540**	W900 x H600mm	£58.45
Y801542**	W1200 x H900mm	£83.15
Y801544**	W1200 x H1200mm	£87.35
Y801546**	W1500 x H1200mm	£126.15
Y801548**	W1800 x H1200mm	£141.80
Y801550**	W2400 x H1200mm	£164.05

** Please specify colour when ordering

Tamperproof Noticeboards

A. Standard tamperproof noticeboards

Inexpensive solution to protecting displayed information against casual interference.

- Each door secures with 2 matching lock for convenience
- Surface accepts Velcro® or pins - colour fast to BS1006
- Available in 5 standard felt colours - Blue (BL), Burgundy (BG), Green (GR), Grey (GY) or Red (RD)

Single Door

YLN31**	W450 x H600mm	each	£62.65
YLN32**	W600 x H900mm	each	£72.80
YLN33**	W900 x H900mm	each	£95.65
YLN34**	W1200 x H900mm	each	£110.10
YLN35**	W1200 x H1200mm	each	£144.75

Double Door

YLN64**	W1800 x H1200mm	each	£215.40
YLN84**	W2400 x H1200mm	each	£253.10

** Please specify colour when ordering



Felt colours:



Blue (BL) Burgundy (BG) Green (GR)



Grey (GY) Red (RD)

A

B. Light oak effect premium aluminium frame EcoColour® tamperproof noticeboard

Stunning light oak effect aluminium frame with EcoColour® recycled material which is not only fire resistant but also has acoustics properties. Our popular EcoColour® material meets the relevant British Fire Safety Standards, and is fast becoming the preferred choice for fire resistant noticeboards in the UK.

- Noticeboard is classified a 'B' according to BS EN13501-1
- Made from recycled material
- Acoustic properties up to NRC 0.8
- Attractive contour frame design
- Available in 11 different colours

Single Door

Y801700**	W600 x H900mm	£178.70
Y801702**	W900 x H1200mm	£234.85
Y801704**	W1200 x H1200mm	£283.05

Double Door

Y801706**	W1800 x H1200mm	£428.80
Y801708**	W2400 x H1200mm	£496.15

** Please specify colour when ordering

Ideal for escape routes/corridors

Acoustic Properties

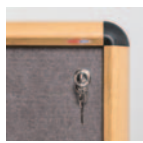

B

C. Light oak effect premium aluminium frame loop nylon tamperproof noticeboard

Stunning light oak wood effect aluminium frame with a traditional yet contemporary finish without the maintenance of real wood.

- Attractive contoured frame design
- Available in standard loop nylon fabric in 17 colours
- Use with pins or Velcro
- Concealed corner fixings and matching keys

Single Door

Y801570	W900 x H600mm	£160.55
Y801572	W1200 x H900mm	£217.20
Y801574	W1200 x H1200mm	£245.65

Double Door

Y801576	W1800 x H1200mm	£381.95
Y801578	W2400 x H1200mm	£438.60

** Please specify colour when ordering



See page 390 for 18 loop nylon colour options



C



A

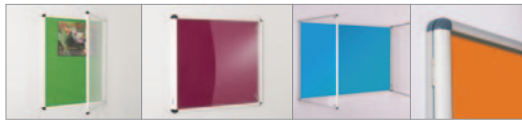

Please note: these items
are made to order

B



Frame colours



Black (BK) Blue (BL) Green (GR) Red (RD) White (WH) Aluminium (AL)

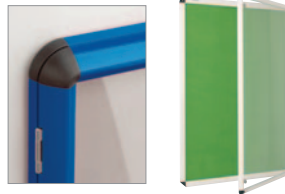

Standard Loop Nylon Range



Black (BK) Blueberry (BB) Bottle Green (BG) Dark Wine (DW) Emerald Green (EG) Gunmetal (GM) Ink Navy (IN) Light Grey (LG) Yellow (YL) Quince (QU) Royal Blue (RB) Purple (PU) Magenta (MG) Lilac (LC) Orange (OR) Cyan (CY) Apple (AG) Scarlet (SC)

Tamperproof Noticeboards

A. Colourtone vibrant tamperproof noticeboards

- Stunning range of lockable notice boards in 6 colours
- 2 matching locks per door
- Full length glazing bars and quality hinges
- Aluminium frame, with fixings

Single Door

Y31012**	W600 x H900mm	each	£93.80
Y31014**	W900 x H900mm	each	£117.30
Y31016**	W1200 x H900mm	each	£132.55
Y31017A**	W1200 x H1200mm	each	£154.60

Double Door

Y31019A**	W1800 x H1200mm	each	£237.00
Y31021A**	W2400 x H1200mm	each	£280.25

** Please specify colour when ordering



Apple Green (AG) Cyan (CY) Magenta (MG) Lilac (LL) Orange (OR) Purple (PR)

B. Premium tamperproof noticeboard

Contemporary framed lockable noticeboard.

- Contemporary styling with a wide range of frame and cloth colours
- Available in 6 different sizes all with standard loop nylon cloth
- Heavy duty design with 3mm thick PET covers and full length glazing bars
- Key Lock
- No door options are also available - please ask for details

Single Door

		Aluminium Frame	Coloured Frame
Y801260**	W600 x H900mm	£137.25	£195.70
Y801262**	W900 x H900mm	£173.50	£227.85
Y801264**	W900 x H1200mm	£187.70	£249.25
Y801266**	W1200 x H1200mm	£217.85	£292.10

Double Door

Y801268**	W1800 x H1200mm	£327.85	£439.40
Y801270**	W2400 x H1200mm	£370.90	£486.75

** Please specify colour of material and frame when ordering

Interior Showcases

A. Premium interior showcases

The elegantly styled premium Showcase has a top hinged door with support stays and 2 matching locks. Pinnable area is based on multiples of A4 sheets to maximise space utilisation. Standard & Resist-a-Flame versions are available.

- Each unit has two locks with matching keys
- Framework is available in anodised Aluminium (AL) or powder coated in Blue (BL), Red (RD), Green (GR), White (WH), Black (BK) or Light Oak (LO)
- Standard version are available in 12 popular loop nylon colours, accept pins and Velcro®.
- Resist-a-Flame® versions available, fully constructed to meet the latest building and fire regulations
- Tested to the relevant European 'reaction to fire' tests
- Easy to mount with concealed bracket, fixings provided



Light Oak Effect Frame

Standard showcases

YINTL4**	W712 x H570mm (A)	£205.35
YINTP4**	W537 x H750mm (B)	£197.70
YINTL8**	W967 x H750mm (C)	£265.05
YINTP8**	W752 x H1050mm (D)	£266.00
YINTP12**	W1012 x H1050mm (E)	£307.40
YINTP15**	W1182 x H1050mm (F)	£323.05
YINTP18**	W1397 x H1050mm (G)	£366.00

EcoColour® Resist-a-Flame® showcases

Y801580**	W712 x H570mm (A)	£220.05
Y801582**	W537 x H750mm (B)	£212.70
Y801584**	W967 x H750mm (C)	£290.40
Y801586**	W752 x H1050mm (D)	£297.55
Y801588**	W1012 x H1050mm (E)	£349.65
Y801590**	W1182 x H1050mm (F)	£378.00
Y801592**	W1397 x H1050mm (G)	£427.35

** Please specify colour of material and frame when ordering



Please note: these items are made to order



Standard Loop Nylon Range

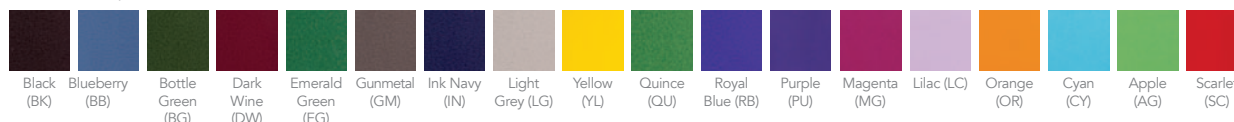

EcoColour® Resist-a-Flame® Range



Frame colours

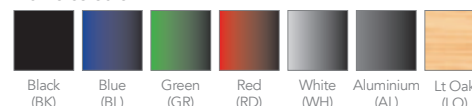

Resist-a-flame® Noticeboards

A. Aluminium frame EcoColour® noticeboards

A fantastic range of recycled noticeboards with aluminium frame that are not only fire resistant but also have acoustic properties. These boards are made from recycled plastic and in the production of the 1200 x 900mm option there are typically 33 x 25g plastic bottles

- Noticeboard is classified a 'B' according to BS EN13501-1
- Made from recycled materials
- Acoustic properties up to NRC 0.8
- Self- coloured pinnable core
- Available in 11 different colours

Y801520**	W900 x H600mm	£44.95
Y801522**	W1200 x H900mm	£73.35
Y801524**	W1200 x H1200mm	£90.65
Y801526**	W1500 x H1200mm	£108.15
Y801528**	W1800 x H1200mm	£138.80
Y801530**	W2400 x H1200mm	£163.95

** Please specify colour when ordering

A

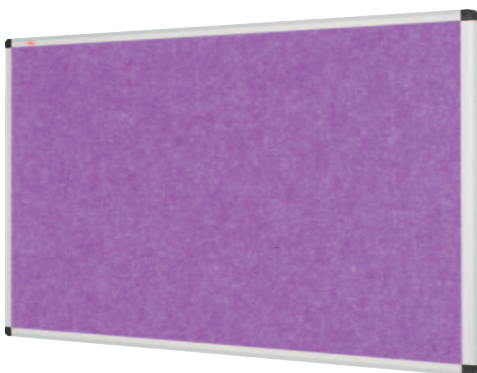
Acoustic
PropertiesFIRE
RESISTANTIdeal for escape
routes/corridors

Raspbery RS Red RD Orange OR Apple Green AP Blue BL Purple PU Grey GY Charcoal CH Green GR Lt Blue LB Natural NA

Please note: these items
are made to order

Page Link - see pages

More EcoColour
Resist-a-Flame
Noticeboards

386-389



B. Tamperproof EcoColour® fire resistant noticeboards

Our popular EcoColour® material meets the relevant British Fire Safety Standards, and is fast becoming the preferred choice for fire resistant noticeboards in the UK

- Side hinged lockable noticeboards
- Noticeboard is classified a 'B' according to BS EN13501-1
- 2 locks per door with matching locks
- Clear covers tested to BS 476 part 7 class 1
- Range of 11 standard colours
- Acoustic properties up to NRC 0.8

Single Door

Y801620**	W600 x H900mm	each	£115.50
Y801624**	W900 x H1200mm	each	£160.35
Y801625**	W1200 x H1200mm	each	£190.50

Double Door

Y801626**	W1800 x H1200mm	each	£289.80
Y801628**	W2400 x H1200mm	each	£339.65

**Please specify colour when ordering.

B

FIRE
RESISTANTAcoustic
Properties

EcoColour® Resist-a-Flame® Range

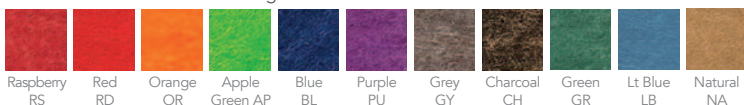

Raspbery RS Red RD Orange OR Apple Green AP Blue BL Purple PU Grey GY Charcoal CH Green GR Lt Blue LB Natural NA



Resist-a-flame® Noticeboards

A. Top hinged tamperproof EcoColour® fire resistant noticeboards

Our popular EcoColour® material meets the relevant British Fire Safety Standards, and is fast becoming the preferred choice for fire resistant noticeboards in the UK.

- Top hinged lockable noticeboards with door supports
- Ultimate choice for use in corridors
- Doors open upwards and kept in place with support stays
- 2 locks per doors with matching keys
- Range of 11 standard colours
- Noticeboard is classified a 'B' according to BS EN13501-1

Single Door

Y801630**	W900 x H600mm	each	£130.90
Y801632**	W900 x H900mm	each	£166.40
Y801634**	W900 x H1200mm	each	£176.10
Y801636**	W1200 x H900mm	each	£175.90
Y801638**	W1200 x H1200mm	each	£207.30

Double Door

Y801640**	W1800 x H900mm	each	£330.85
Y801642**	W1800 x H1200mm	each	£350.20
Y801644**	W2400 x H1200mm	each	£412.85

**Please specify colour when ordering.

EcoColour® Resist-a-Flame® Range



B. Premium sliding door EcoColour® fire resistant showcases

- Sliding lockable door option, ideal for busy corridors
- Doors manufactured from toughened safety glass
- Range of 11 standard colours
- Available in 4 sizes designed to take a given number of A4 sheets
- Framework is available in anodised Aluminium (AL), powder coated in White (WH), or Light Oak (LO) effect aluminium frame

Y801612**	W967 x H750mm	each	£360.00
Y801614**	W1012 x H1050mm	each	£388.10
Y801616**	W1182 x H1050mm	each	£459.00
Y801618**	W1397 x H1050mm	each	£525.00

** Please specify colour of material and frame when ordering

Frame colours

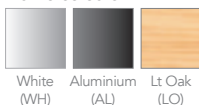

EcoColour® Resist-a-Flame® Range

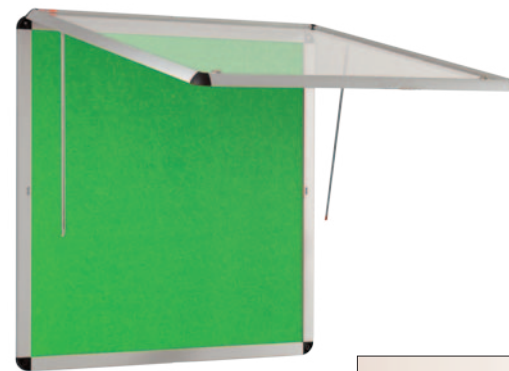

Please note: these items are made to order



Light Oak Effect Frame



Freestanding Exterior Showcases

A. Premium post mounted exterior showcases

- Post mounted weatherproof showcase for sinking into concrete
- Specification as per premium Exterior Showcase, with the addition of powder coated steel backing plate for rear weatherproofing
- Galvanised and powder coated heavy duty steel posts to take single or double sided showcases
- Finished height of the unit is 2.0m
- Available in four size options, supplied as a single showcase and a pair of applicable posts
- Extra showcase available individually to create a double sided unit
- Please specify frame and infill colours required

Direct delivery 2-3 weeks

In-the-ground posts

		Takes	
YPMS9**	W752 x H1050mm	9 x A4	£596.10
YPMS12**	W1012 x H1050mm	12 x A4	£653.35
YPMS15**	W1182 x H1050mm	15 x A4	£681.15
YPMS18**	W1397 x H1050mm	18 x A4	£741.25

Extra showcase (without posts)

		Takes	
YEXS9**	W752 x H1050mm	9 x A4	£350.65
YEXS12**	W1012 x H1050mm	12 x A4	£402.30
YEXS15**	W1182 x H1050mm	15 x A4	£452.90
YEXS18**	W1397 x H1050mm	18 x A4	£497.70

** Please specify colour of material and frame when ordering

Please note: these items are made to order



Frame colours

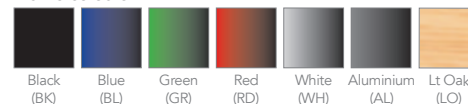

Light Oak Effect
Frame Option

Wall Mounted Exterior Showcases

A. Premium exterior showcases

Popular covered noticeboards that are designed to protect your information against the elements. All showcases are truly weatherproof and meet the IP55 requirements of EN60529 for water and dust ingress.

- Wall mounted units have top hinged doors with support stays and two matching locks
- The internal display area is based on displaying multiples of A4 sheets of paper
- Framework is available in anodised Aluminium (AL) or powder coated in Blue (BL), Red (RD) or Green (GR), White (WH), Black (BK) or Light Oak Effect (LO)
- The internal display area is pinnable with a choice of 18 standard loop nylon colours or cork
- Supplied complete with fixings

YEXTL4**	W712 x H575mm (A)	£214.20
YEXTP4**	W537 x H750mm (B)	£210.40
YEXTL8**	W967 x H750mm (C)	£276.75
YEXTP8**	W752 x H1050mm (D)	£276.75
YEXTP12**	W1012 x H1050mm (E)	£325.25
YEXTP15**	W1182 x H1050mm (F)	£348.40
YEXTP18**	W1397 x H1050mm (G)	£391.85

** Please specify colour of material and frame when ordering



Installation not included



Light Oak Effect
Frame Option

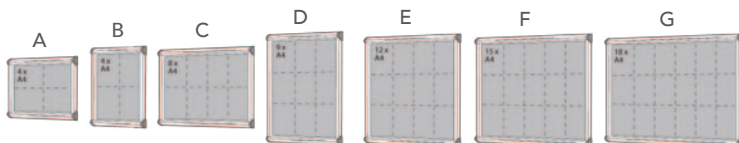

Please note: these items
are made to order

Standard Loop Nylon Range

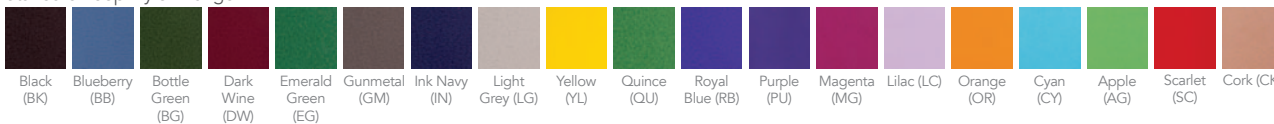

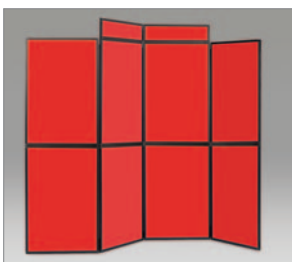
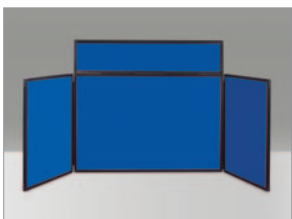
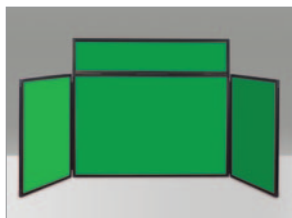

Please note: these items are made to order

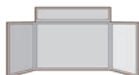

EYDB3PH Mini Table Top
Overall Size
W1800 x H800mm
Weight 3kg



MXT69 Maxi Table Top
Overall Size
W1800 x H1100mm
Weight 4kg

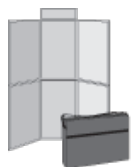

6 Panel + Header

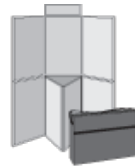

7 Panel + Header &
Triangular Shelf



8 Panel + 2 Headers

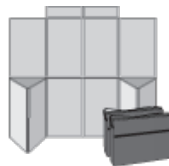

10 Panel + 2 Headers & 2
Triangular Shelves

Standard colours



Royal Blue (RB) Alpha Red (AR) Emerald Green (EG) Twin Col. Blue/Grey (TW)

Extended colour range - allow an additional 2-3 days for delivery



Black (BK) Burgundy (BU) Yellow (YL) Cyan (CY) Apple (AG) Lilac (LC) Magenta (MG) Orange (OR) Purple (PU)



Folding Display Systems

A. Lightweight tabletop displays

- Ideal for presentations and displays, course work or exhibitions and fairs
- Double sided panels fold down to 900 x 600mm.
- All panels are double sided with a choice of loop nylon covering, which accepts Velcro® or Busyfix as well as pins
- Available in landscape or portrait formats
- All come with header panels and carry bags
- 4 standard and 10 extended loop nylon colour options
- Black or grey frame options

Maxi: Portrait All 3 panels 600 x 900mm
Header panel 600 x 200mm

Mini: Landscape centre panel 900 x 600mm
Side panels 450 x 600mm
Header panel 900 x 200mm

YMXT69**	Maxi Table Top	each	£127.75
YEYB3PH**	Mini Table Top	each	£109.35

Lightweight folding display systems

- Features as for the tabletop display system above
- 600 x 900mm panels are linked with flexible hinging, and clip on top of each other for easy assembly

B. Fast fold 6 panel system

- 6 x 600mm x 900mm panels
- 1 x 600mm x 200mm header • Weight: 8.5kg

YEYB6P**	6 Panel	£206.60
----------	---------	---------

C. Fast fold 7 panel

- 7 x 600mm x 900mm panels, 1 x triangular shelf
- 1 x 600mm x 200mm header • Weight: 13.7kg

YEYB7P**	7 Panel	£261.00
----------	---------	---------

D. Fast fold 8 panel

- 8 x 600mm x 900mm panels
- 2 x 600mm x 200mm headers • Weight: 11kg

YEYB8P**	8 Panel	£273.35
----------	---------	---------

E. Fast fold 10 panel

- 10 x 600mm x 900mm panels
- 2 x 600mm x 200mm headers
- 2 x triangular shelves • Weight: 24kg

YEYB10TP**	10 Panel	£351.05
------------	----------	---------

F. Panel bags

YBAG69S	Standard Bag (Holds 7-8 Panels)	£61.00
YBAG69LG	Large Bag (Holds 10 Panels)	£80.00

** Please specify colour when ordering

Folding Display Systems

Heavy duty system kits

- Buy the complete package - heavy duty system kits which include headers and a carrying bag
- These packages are a convenient and cost effective solution for purchasing a folding display system
- Robust system framed in aluminium
- Folding panel system with 700 x 1000mm panels, framed with anodised aluminium interlocking gear hinge, which prevents daylight showing between the panels
- Top and bottom panels lock on top of each other for greater security
- Available in 3, 6 or 7 panels with a single header, while the 8 panel option has 2 headers
- The system is stored in a rugged carry bag
- Double sided panels are covered in a choice of 4 loop nylon colourways which are fire retardant to BS5867
- Accepts Velcro® as well as pins
- Available in 4 standard & 10 extended range colours

YDB3P**	3 Panel with Header	£177.85
YDB6P**	6 Panel with Header	£293.55
YDB7P**	7 Panel with Header	£350.05
YDB8P**	8 Panel with 2 Headers	£405.30

** Please specify colour when ordering

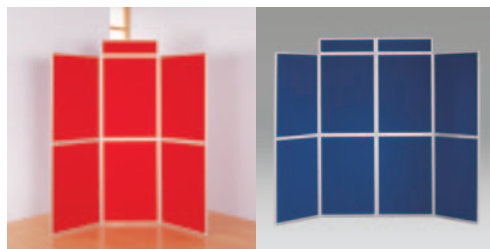
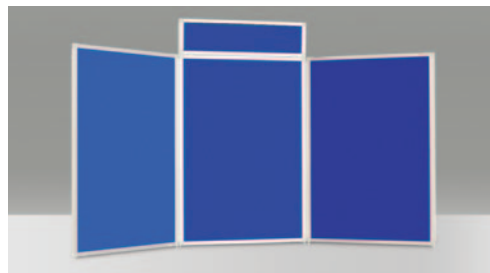

Standard colours



Royal Blue (RB)
Alpha Red (AR)
Emerald Green (EG)
Twin Col. Blue/Green (TW)

Extended colour range - allow an additional 2-3 days for delivery



Black (BK)
Burgundy (BU)
Yellow (YL)
Cyan (CY)
Apple (AG)
Lilac (LC)
Magenta (MG)
Orange (OR)
Purple (PU)

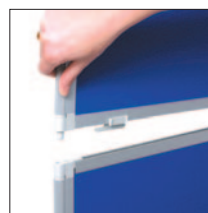

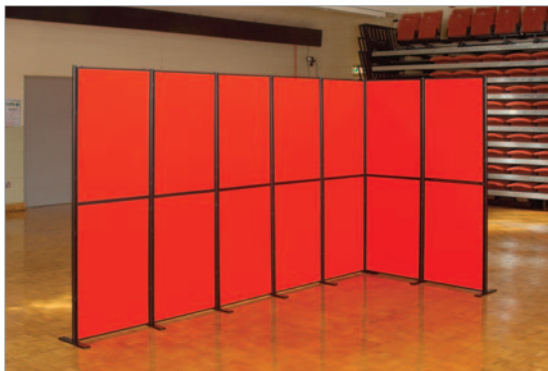

6 Panel + Header



6 Panel

7 Panel +
Triangular Shelf

8 Panel

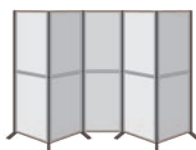

10 Panel

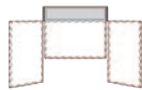
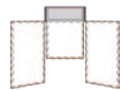
Header Set
0.2 x 0.9mHeader Set
0.2 x 0.6mPanel
0.6 x 0.9m

Pole Set

Standard colours



Royal Blue (RB) Alpha Red (AR) Emerald Green (EG) Twin Col. Blue/Grey (TW)

Extended colour range - allow an additional 2-3 days for delivery



Black (BK) Burgundy (BU) Yellow (YL) Cyan (CY) Apple (AG) Lilac (LC) Magenta (MG) Orange (OR) Purple (PU)

Folding Display Systems

Onboard pole and panel display systems

- A lightweight pole and panel system that due to its modular design enables the user to reconfigure and extend the display system to meet the application
- Standard 600 x 900mm panels can be mounted both portrait or landscape onto the 1800mm high pole, using C clips provided
- The system can be extended at any point in the future by purchasing another kit to link on
- All panels are doublesided with a choice of loop nylon covering, which accepts Velcro or Busyfix as well as pins
- Header panels have loop nylon fabric on one side and black on reverse
- Available in 4 standard colours & 10 extended range colours

A. 6 panel kit – 9.5kg

YPPDB6H**	6 – 600 x 900mm Display Panels		
	1 – 900 x 200mm Header	each	£284.50
YPBAG78	Panel Bag - 7-8 Pane	each	£61.00

B. 6 panel kit – 9kg

YPPDB6**	6 – 600 x 900mm Panels	each	£262.40
YPBAG78	Panel Bag - 7-8 Pane	each	£61.00

C. 7 panel kit – 10kg

YPPDB7H**	7 – 600 x 900mm Display Panels		
	1 – Triangular Shelf	each	£314.15
YPBAG78	Panel Bag - 7-8 Panel	each	£61.00

D. 8 panel kit – 10.5kg

YPPDB8**	8 – 600 x 900mm Panels	each	£333.00
YPBAG78	Panel Bag - 7-8 Panel	each	£61.00

E. 10 panel kit – 14.5kg

YPPDB10**	10 – 600 x 900mm Panels	each	£403.75
YPBAG10	Panel Bag - 10 Panel	each	£80.00

F. Accessories

YHEAD62**	Header Panel 200 x 600mm	each	£32.25
YHEAD92**	Header Panel 200 x 900mm	each	£35.15
YPNL96**	Extra Panel 600 x 900mm	each	£43.50
YPOLESET	Pole Set Black	set	£33.00

** Please specify colour when ordering these products

A. Concertina Mobile Room Dividers

- Ideal for temporary room divisions
- Double sided and available in 3 heights and 4 panel configurations
- A wide range of colours in velcro friendly Nylon loop
- Also available in elegant wool mix fabric
- Each panel comes with two lockable castors and folds neatly for easy storage
- Delivery 5-7 working days

Code	Description	Height	Price
YCD124**	4 Panel	1200mm	£485.00
YCD125**	5 Panel	1200mm	£575.00
YCD127**	7 Panel	1200mm	£750.00
YCD129**	9 Panel	1200mm	£995.00
YCD154**	4 Panel	1500mm	£506.00
YCD155**	5 Panel	1500mm	£594.00
YCD157**	7 Panel	1500mm	£788.00
YCD159**	9 Panel	1500mm	£1068.00
YCD184**	4 Panel	1800mm	£520.00
YCD185**	5 Panel	1800mm	£642.00
YCD187**	7 Panel	1800mm	£818.00
YCD189**	9 Panel	1800mm	£1122.00

** Please specify colour when ordering

Available colours

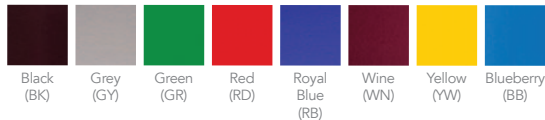

B. Instant mobile display wall

This mobile partitioning is ideal for temporary dividing of large rooms, reception areas and halls. It can be used just as a divider or for presentations and displays. The design ensures it is completely stable in any position including: straight line, bays, curves or forming right angles.

- Fits neatly into its own self-contained frame
- Easily folds away when not in use
- Lightweight but sturdy structure is safely and easily operated by one person
- Lockable castors and full-length piano hinges fitted to each panel
- Individual panel size W600 x H1800mm

Y820540	W1800 x H1940mm (3 panel system)	£784.00
Y820542	W3000 x H1940mm (5 panel system)	£957.00
Y820544	W4200 x H1940mm (7 panel system)	£1223.00

Available colours



Best Seller



Also available in wipeable anti-bacterial material. Please ask for prices

Please note: for safety reasons the room dividers cannot be used flat and must be angled for stability purposes. Using zig-zag configuration, it is recommended that 2 panels = 1 metre

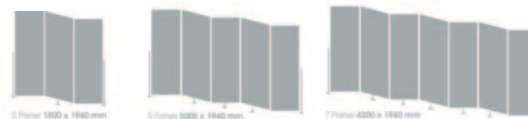



Premium glazed display cases

A stylish range of display cases manufactured to the highest standard. Heavy duty yet contemporary aluminium framing, and toughened safety glass are used to create this range of wall and freestanding showcases.

- Delivered fully assembled
- Choice of 2 frame finishes - anodised satin silver or powder coated blue
- 6mm toughened safety glass
- Adjustable shelves
- Lockable castors
- Optional header and/or bottom cupboards - price on request
- Illuminated version comes complete with 4 halogen lights

A



A. Wall cabinet with sliding doors

Size H1000 x W1000 x D250mm

Y801800	Satin Silver	£1040.00
Y801805	Blue	£1130.00

Illuminated

Y801810	Satin Silver	£1250.00
Y801815	Blue	£1340.00

B



B. Tower unit with hinged door

Size H1932 x W500 x D500mm

Y801820	Satin Silver	£1185.00
Y801225	Blue	£1345.00

Illuminated

Y801830	Satin Silver	£1395.00
Y801835	Blue	£1555.00

C



C. Wide tower unit with sliding doors

Size H1932 x W1000 x D450mm

Y801840	Satin Silver	£1705.00
Y801845	Blue	£1899.00

Illuminated

Y801850	Satin Silver	£1915.00
Y801855	Blue	£2100.00

Please note: these items are made to order

Premium plus glazed display cases

The Premium Plus range of glass display cases offers a contemporary modern styling to the aluminium frame.

- Delivered fully assembled
- Anodised satin silver aluminium construction
- 6mm toughened safety glass
- Lockable doors
- Adjustable shelves
- Lockable castors
- Three top-fitted halogen lights as standard
- Button feet available on request
- Optional side strip light - price on request



A. Tower display case with hinged door

- H1932 x W735 x D317mm

Y801860

£1430.00



B. Tower display case with sliding door

- H1932 x W1135 x D317mm

Y801865

£3275.00

Page Link - see pages
For
Reception
Desks

294-304



Page Link - see pages
For
Reception
Seating

224-251



Page Link - see pages
For
Artificial
Plants

305



Lecterns

A. Panel front lectern

Practical mobile lectern

- Popular mobile lectern finished in beech look panelling and grey steel framework
- Upper shelf angled with book rest to aid presentation, together with lower accessory shelf
- Lectern mounted on four castors two of which are locking



A

	(H)	(W)	(D)		
YPFLECT	1200	x 600	x 450mm	each	£225.00

Please note: these items are made to order



B

B. Coloured panel front lecterns

- A colourful addition to the popular beech version
- New contemporary range of 7 colours
- Dark grey steel framework
- Dimensions: H1200 x W600 x D450mm

Y31019	Orange	each	£235.50
Y31021	Blue	each	£235.50
Y31023	Lime Green	each	£235.50
Y31030	Grey	each	£235.50
Y31027	Black	each	£235.50
Y31029	Red	each	£235.50
Y31031	White	each	£235.50

C. Static lectern

- Stylish lectern for a perfect fit in all environments
- Small shelf provides space for notes and drinks
- Space for routing microphone wires internally
- W600 x D400 x H1170mm
- Available in 11 different wood finishes with 4 metal trim colours

Y800910	Static Lectern	each	£525.00
---------	----------------	------	---------

Metal finishes



Black Grey Silver White



Wood finishes



Beech Classic Ash Light Oak Modern Oak Maple Plain Grey Portofino Cherry Swiss Elm Verade Oak Walnut White

AV Cabinets

A. Premium multi-media projector cabinet

- Premier mobile multi-media cabinet
- Market leading cabinet with extra security and features
- Designed to house all multi-media projection equipment.
- Three point lock for added security.
- Contoured rounded edging to top and base panels
- Rear hinged panel for easy access to cabling.
- Additional cable ports and cable tidy
- Accessory storage tray to inside of door
- Size: H930 x W524 x D570mm

YSCMPBH Premium Multi-Media Projector Cabinet, Beech £348.15

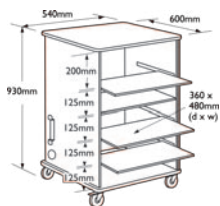

A

B. Premium coloured mobile multi-media cabinets

- The premium cabinet has now been developed in a range of 7 striking colours
- Premier coloured secure projector cabinets designed to house all multi-media projection equipment
- Rear lockable access door
- 4 shelves, 3 of which slide
- Ready assembled in 7 colours
- Size H930 x W524 x D570mm

Y31033	Red	£410.00
Y31036	Grey	£410.00
Y31037	Orange	£410.00
Y31039	Blue	£410.00
Y31041	Lime Green	£410.00
Y31043	Black	£410.00
Y31045	White	£410.00



B



Please note: these items are made to order



Creating sustainable learning environments for pupils & teachers
Effective acoustic solutions for a wide range of education environments.
Combine aesthetics and design with acoustic performance, for all education environments.

Acoustic Surfaces

HushBoard	406-407
HushPanel	408-409

Acoustic Surfaces

Background noise can be a significant problem in halls, corridors, open-plan areas, breakout zones and larger rooms.

Noise nuisance is a distraction to staff and pupils alike, hindering concentration and communication levels and reducing the effectiveness of teaching and co-operative working.

HushBoards and **HushPanels** might be the answer to your noise pollution problems. Talk to us about your needs and ask for a no obligation quotation.



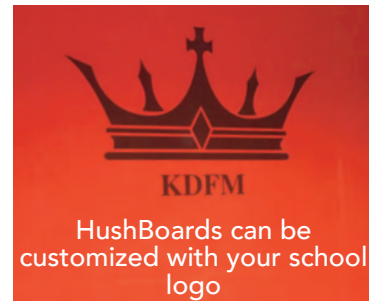

Page Link - see pages
For
acoustic
noticeboards

386-392



Pin, staple & Velcro friendly

Other products from the Hush range



HushBlox

Stackable acoustic blocks allowing you to configure your learning space any way you want



Colours
may vary



HushTree

Large room divider providing acoustic properties with a fun and aesthetically pleasing design

HushBoard Acoustic Surface

Transform your environment and comply with acoustic directives.

Statistics have shown that 25% of children cannot hear properly in the classroom which can result in learning difficulties. Install *HushBoard* and boost their learning performance.

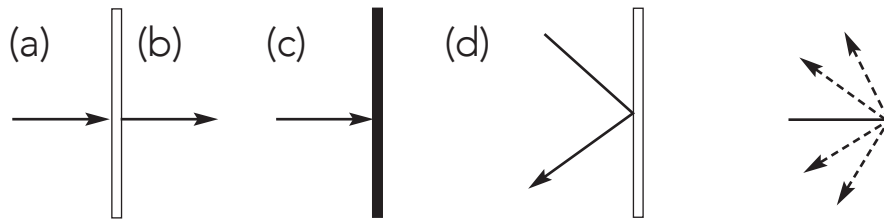

- (a) Sound transmission - the sound passes through the surface into the space beyond
- (b) Absorption - the surface absorbs the sound like a sponge absorbs water
- (c) Reflection - the sound hits the surface and changes direction like a ball bouncing off a wall. This creates reverberated noise.
- (d) Sound Diffusion - the sound strikes the surface and is scattered in many directions, like pins being hit by a bowling ball

Hushboard Acoustic Surface

HushBoard is a superb decorative wall covering, specifically developed to enhance the educational environment. Its felt surface transforms noisy interiors as well as creating a colourful, highly durable and exciting surrounding.

- Perfect for use in schools, colleges and nurseries
- Improves teaching and learning by absorbing excess classroom noise
- Acoustic rating of NRC 0.40 is proven to reduce noise levels by 40%
- Pin, staple and velcro friendly, perfect for displays!
- Highly durable, resistant to staining and easily cleaned
- Saves the time and expense of recovering traditional wall boards
- Large range of 35 eyecatching, non fade colours
- Professional fitting service available for your own imaginative designs
- Recommended for a minimum 8 year cycle
- Fire retardant
- Call today for a sound survey and free quotation



Due to the limitations of print, colours will vary from those shown above. Call for a FREE sample swatch for accurate colour selection



Avocado Spearmint Sage Jade Lime Wasabi Granny Smith Azure Octane Stately Ink Stonewash Atlantis Electric Blue Calypso Blush Phantom Raspberry Theatre



Chilli Red Blazing Red Lightsout Cinder Citrus Clay Simba Vintage Brilliant Orange Bark Porcelain Myst Fawn Sanz Koala Silver Civic Charcoal Noir



Page Link - see page
 Statik
 seating
 range shown

200



HushPanel

HushPanel is an innovative 25mm or 50mm thick acoustic panel, that is engineered to provide superior sound absorption with balanced acoustic design. Ideal for wall and ceiling applications, HushPanel is unique in it's availability to be supplied as either a pre-finished panel covered with HushTex acoustic fabric, plain format or custom printed with any image, colour or pattern giving you the flexibility and freedom to create your own designs.

HushPanel Acoustic Surface



HushPanel 'eats up echo'

- Perfect for classrooms, corridors, theatres, communal areas and gymnasiums
- HushPanel transforms noisy interiors to quieter working areas whilst creating colourful and exciting surroundings
- HushPanels are flame retardant, semi rigid, impact resistant, and incredibly durable
- The panels are supplied in sheet form that can be cut and framed onsite, allowing for variations in wall size and shape
- They can also be supplied as custom cut and shaped for increased design flexibility
- This quality product fully answers to the criteria needed for BB93 Noise Level Compliance
- Frames and edge finishing kits are available allowing greater flexibility for constructing large wall areas or unique modular panels



A wide range of standard colours are available as well as bespoke colours and designs. Please enquire for details.

Please contact us for further details and a full technical specification.



Is your playground the Great Outdoors?

Our outside equipment, canopies and seating add that special combination of practicality and fun for all ages.

Outdoor Furniture

A-Frame Benches	412-413
Circular Tables	413,414
Cotswold Range	415
Multicoloured Seat & Bench	416
Stone Effect Furniture	417
Learning Curve	418
Bins	419-421
Bike Racks	421

Outdoor Furniture

We can help you to create fun and pleasant outdoor areas for children and adults alike.

Whether you are looking for some outdoor benching for the teachers to enjoy or a climbing frame for the children, we would love to hear from you.

Take some time to peruse the products and pictures in this Outdoor section and don't hesitate to contact us to discuss your requirements and find out what we can do for you.





A. Outback a-frame table

Made of recycled plastic, and fully recyclable, these environmentally friendly A-Frames are totally weather proof and virtually maintenance free. To prevent "sag" in the seats - as is common with some plastic furniture - they have galvanised steel re-inforcing which we fit as an integral component during manufacture. Also available in other colours to order at extra cost (black, green, grey, light brown).

- Recycled Plastic – and fully recyclable
- Virtually maintenance free and very environmentally friendly
- Totally weather proof with galvanized steel reinforcing
- Built to seat 6 persons
- Size: Overall base L1800 x W1300mm; seat height 450mm, table height 755mm; table width 620mm

YW0032	Outback A-Frame Table	£1249.00
--------	-----------------------	----------



B. Outback bench

Made of recycled plastic, and fully recyclable, these environmentally friendly benches are totally weather proof and virtually maintenance free. To prevent "sag" in the seats - as is common with some plastic furniture - they have galvanised steel re-inforcing fitted as an integral component during manufacture. Also available in other colours to order at extra cost (black, green, grey, light brown).

- Recycled Plastic – and fully recyclable
- Virtually maintenance free & very environmentally friendly
- Totally weather proof
- Galvanized Steel Reinforcing
- Built to seat 4 persons
- Size: L1800 x D670 x Seat Height 450mm, back height 770mm

YW9964	Outback Bench	£1150.00
--------	---------------	----------

A. Standard 6 seater a-frame table

These tables stand the rigorous demands of outdoor use. This traditional design has strength and quality as standard. The table is 1500mm long, and is manufactured using 34mm x 121mm timbers. They are immersed in white spirit based treatment for 3 minutes, which gives them their brown colour.

- Extremely strong design with a substantial construction
- Full immersion spirit treatment
- Timber from managed forestry resources
- Provision for optional parasol & base (extra)
- Re-treatment kits available
- Size: Overall base L1500 x W1270mm; seat height 450mm, table height 760mm; table width 625mm

YW0501	Standard 6 Seater A-Frame Table	£346.80
--------	---------------------------------	---------



B. Circular 8 seater table

Designed for commercial use and built to last; from the double thickness tops to the 46mm x 196mm thick leg the durability is well balanced with user friendliness. These versatile heavy duty outdoor round picnic tables stand up to the rigors and heavy demands that you would expect.

- Built to take 8 persons – a real workhorse
- Free, clear leg room
- Most popular model in the circular tables range
- 1.2m diameter table top (approx)
- Full spirit immersion treatment throughout
- Provision for optional parasol and base (extra)
- FSC® Certified
- Table diameter 1200 x H740mm
- Seats W850 x H440mm
- Overall outer dimensions 1200 x 1935mm

YC8ST	Circular 8 Seater Table	£998.00
-------	-------------------------	---------





A. Softwood picnic bench

- Seats up to eight people
- Sturdy construction
- Table top and bench seats pre-assembled
- Pressure treated to protect against rot
- Natural timber finish
- Can be painted or stained if desired

 YPTSE18

 £349.95



B. Circular 6 seater table

Designed for commercial use and built to last; from the double thickness tops to the 46mm x 196mm thick leg the durability is well balanced with user friendliness. These versatile heavy duty outdoor round picnic tables stand up to the rigors and heavy demands that you would expect. The circular 6 seater is ideal for anyone less able, with access for 3 wheelchairs.

- Easy access / egress seating
- Room for up to 3 wheelchairs
- Could help with your DDA programme
- Built to take 6 or 9 persons
- Table diameter 1200 x H740mm
- Seats W850 x W440mm
- Overall outer dimensions 2050 x 1820mm
- Optional parasol and base available at extra cost - POA

 YC6ST Circular 6 Seater Table

 £949.00

Cotswold Concrete & Wood Range

- Cast steel-reinforced concrete ends provide excellent stability
- Sturdy and robust; these benches offer an ideal solution for playgrounds and public areas
- All prices include delivery

A. Bench (no back)

YS00033	L1830 x W610 x H500mm	£570.00
---------	-----------------------	---------



A

B. Park bench - with back

YS00020	L1830 x W835 x 430mm Seat Height	£682.80
---------	----------------------------------	---------



B



C

C. Rectangle picnic table wheelchair access

- Extended table top L2430 x W710mm

YS00014	Rectangle Wheelchair Access	£946.80
---------	-----------------------------	---------

D. Rectangle picnic table 8 seater

- Table: 1825 x 710mm, Seat height 450mm

YS00001	Rectangle 8 Seater	£886.80
---------	--------------------	---------



D

E. Round picnic table

- 1310mm diameter, 2000mm overall width
- Seats 8 adults comfortably

YS00021	Round Table	£1199.00
---------	-------------	----------



E



A. Multicoloured seat

- Ready assembled
- Ground-fixing bolts
- Vandal-resistant
- Hygienic - easy-to-clean
- Environmentally friendly, made from recyclable plastic

YCPS2	2 Seater	H840 x L1350 x D620mm	£570.00
YCPS3	3 Seater	H840 x L1850 x D620mm	£634.80
YCPS4	4 Seater	H840 x L2050 x D620mm	£670.80



A

B. Wellington outdoor bench

- Hardwood construction
- Shaped seat and back rest for comfort
- Seats up to two people
- Easy assembly
- Factory stain finish

YWL12	Width 1200mm	£298.00
YWL15	Width 1500mm	£349.00



B

C. Clarendon teak bench

- High quality solid Teak finished to a high specification
- Engraving available - please ask for details

YCB12	1200mm	£654.00
YCB15	1500mm	£746.80
YCB18	1800mm	£778.80



C

Page Link - see page

For
round
bins...

419



Stone Effect Tables And Seating

- Highly popular maintenance free
- Ready assembled
- Available in stone colours only
- Vandal resistant
- Made from recycled and recyclable plastic

A. Premier bench without backs

YPB3	3 Seater	H410 x L1850 x D560mm	£543.60
YPB4	4 Seater	H410 x L2050 x D560mm	£594.00



A

B. Table set

- Table and 2 benches

YPTB6	6 Seater	L1850mm	£1626.00
YPTB8	8 Seater	L2050mm	£1750.80



B

C. Premier seats with backs

YPS3	3 Seater	H840 x L1850 x D620mm	£622.80
YPS4	4 Seater	H840 x L2050 x D620mm	£634.80



C

Plain colours

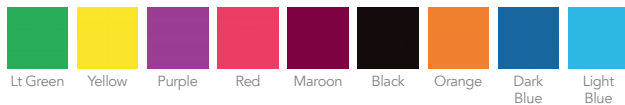

Stone effect colours

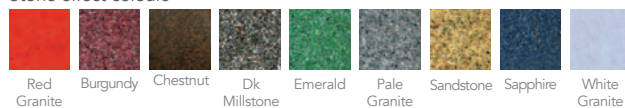

Page Link - see page

For
round
bins...

419



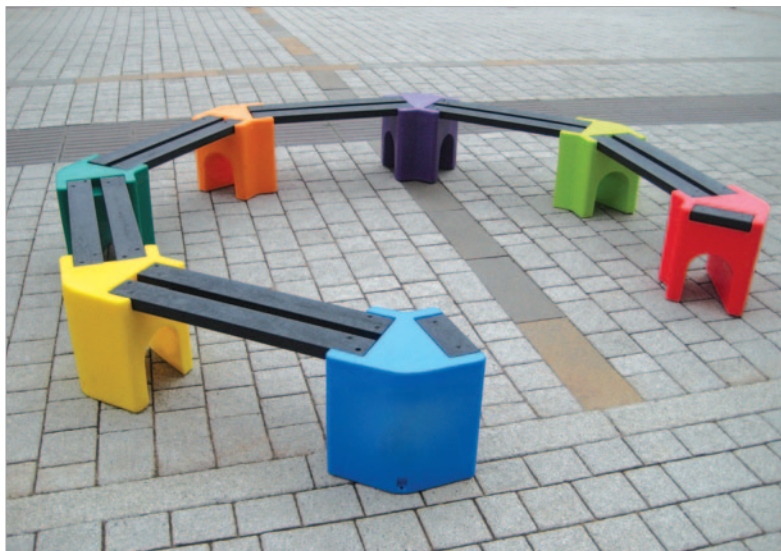

Item shown YLC1. Please ask for details of other options in this range.

A. Learning curve

- Seat Height: 380mm
- Length of each seat: 800mm
- Overall diameter: 2600mm
- Maintenance free and easy to clean
- Ground fixing supplied
- Recycled and recyclable plastic
- Simple self assembly is required

YLC1 2600mm Diameter POA

Page Link - see pages

For Plastic
Lockers

159



Call now
for a free
quotation

*Your imagination!
Your creation!
Flexible seating, with flat
tops or planter boxes.*

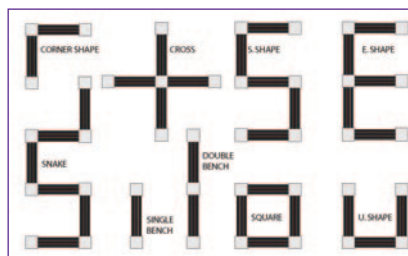

Other configurations available - please ask for details

A. Classic bins

- Can be printed - please ask for details
- Polyethylene outer shell
- Galvanised steel liner
- Lock and Key
- Weighted base
- Easy to clean
- Size: H1130 x 520mm diameter
- 90 litre capacity
- Available in all colours, stone colours shown in picture

YCLB	Classic Bin Standard Design	£358.80
------	-----------------------------	---------



A

Plain colours

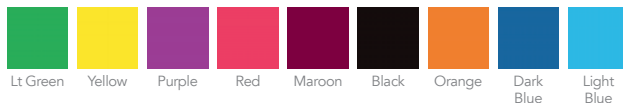

Lt Green Yellow Purple Red Maroon Black Orange Dark Blue Light Blue

Stone effect colours

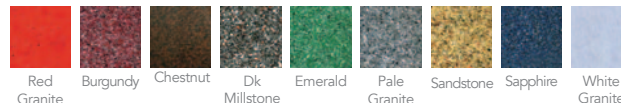

Red Granite Burgundy Chestnut Dk Millstone Emerald Pale Granite Sandstone Sapphire White Granite

B. Grove litter bin

- A litter bin made from FSC® Certified wood
- Robust and hard wearing
- Removable lid for ease of emptying
- Unique Woodberry spirit immersion wood treatment
- 40L Galvanised steel bin liner inside
- Easy to empty
- Can be ground fixed for security
- 427mm x 427mm x 855mm tall

YWGR100BN	Grove Litter Bin	POA
-----------	------------------	-----



B

C. Grit bins

Our roadside standard grit bins are perfect for helping you to keep your paths and driveways ice free.

- **Standard Grit Bin:** H710mm x W840mm x D500mm, capacity: 200 litres
- **Large Grit Bin:** H920mm x W1050mm x D670mm, capacity: 400 litres

YBBGBS	Standard	each	£322.80
YBBGBL	Large	each	£382.80



C

D Proline outdoor table tennis table

- A static & very sturdy outdoor table; ideal for playgrounds
- A hard, dense playing surface meets ITTF bounce standards and patented MATTOP® finish provides an antiglare finish and proper ball adherence
- 60mm structural galvanised steel frame
- 7mm resin laminate top
- Complete with a permanent tamperproof steel net
- 4 side slots storing table tennis bats
- Available with a Blue or Grey top

YTT1050OD	£1194.00
-----------	----------

Table Top Colours

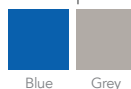

Blue Grey



D

A



A. Wall/post mounted bin

- Lock and key
- Wall or post mounting
- Polyethylene bodyshell
- Internal galvanised steel liner
- Environmentally friendly - made from recyclable plastic
- Wall fixing bolts supplied
- Hygienic, easy to clean
- Size H675 x W440 x D310mm
- Capacity 26L



YMPW

£238.80



Red Dark Green Light Green Dark Blue Black

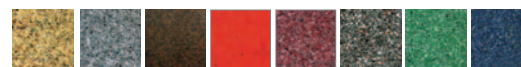

Sandstone Pale Granite Chestnut Red Granite Burgundy Dark Millstone Emerald Sapphire

B



B. Strongbox recycling bin system - set of 4

- Polyethylene bodyshell
- Galvanised steel liner
- Pivoting bin for ease of emptying
- Hygienic - easy to clean
- Environmentally friendly - recyclable plastic
- Can be wall mounted
- Size: H920 x D400 x W510mm
- Capacity 39 litres

YRVP

£1626.00



Light Blue Purple Dark Green Light Green Maroon



Red Orange Dark Blue Black Grey

C



C. Tuftec litter bin

- Outdoor Heavy Duty 100L Tub Bin
- Contoured design with a wide base which allows for maximum capacity and stability
- 2 Piece design – lift off cover with an inner metal liner
- Concrete or soil fixings also available – POA
- Black finish
- Dimensions: H1030 x D540mm

YTTB100

£198.00

A. Mushroom litter bins

- 90L capacity mushroom shaped bin
- Polyethylene bodyshell
- Galvanised steel liner
- Hygienic, easy to clean
- Made from recyclable plastic
- Supplied with a lock & key (use key to unlock and access liner bin)
- Available with or without printed spots
- Comes in 9 bright colours: Light Green, Yellow, Purple, Dark Blue, Light Blue, Orange, Maroon, Black and Red
- Size: H900 x D720mm

YMUL01	Without Spots	£418.80
YMULS01	With Spots	£430.80

Colours

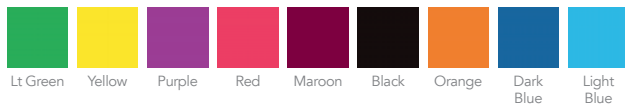

B. Pencil bins

- Polyethylene outer shell
- Galvanised steel liner
- Lock and Key
- Available in all plain colours

YPMIC	Micro; H1040, 390 dia. 42 Litre	£318.00
YPMID	Midi; H1200, 390 dia. 52 Litre	£330.00
YPMICL	Pencil Bin with 'Litter' Letters, 42 Litre	£322.80
YPMIDL	Pencil Bin with 'Litter' Letters 52 Litre	£342.00

Colours

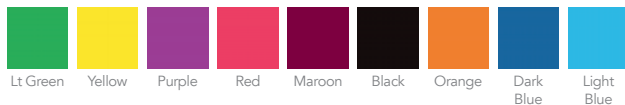

C. Wall mounted cycle holders

- Made from Heavy Duty Galvanised Steel
- Available with 90° or 45° angle to the wall

YSPR11	Cycle Holder	POA
--------	--------------	-----

D. Cycle toast rack

- 4m wide
- Made from heavy duty galvanised steel, comes flanged for bolting down only

YSPTR05	Galvanised For 10 Cycles	POA
---------	--------------------------	-----



A



B



C



D



Planning a school refurbishment over the holidays?

Or refreshing a 'tired' interior? We have the design experience and project 'know-how' to create and deliver the perfect result you're looking for without the hassle!

Design & Refurbishment

Eco Classrooms	424-425
Washrooms	426-427
Libraries & Learning Zones	428
Staffrooms & Tea Points	429
IT Suites	430
Cloakrooms & Changing Rooms	431
Reception Areas	432
Offices & Meeting Rooms	433
Science Laboratories	434-435
Home Economics	436
Classroom Refurbishment	437
Staging & Auditorium Seating	438-439
Outdoor Spaces	440-441
Shelter & Shade	442-443

Design & Refurbishment

Your new-build, extension or total refurbishment can safely be left entirely in our care. If you wish, we will undertake the whole process from initial consultation and plans right through to furniture, fittings and final sign off.

Or, if you prefer, we are happy to work with your architect or designer to bring your plans to life. Our aim is to relieve you of as much of the hassle as possible – leaving you to focus on what you are best at.





Eco Classrooms

- **Timber Frame Eco Classroom Buildings** offer many advantages over both Conventional Builds, and Temporary Portable Buildings, making them a sustainable and practical choice for educational spaces.
- **Reducing the Environmental Footprint:** At the core of the eco classroom concept is sustainability. By using environmentally friendly timber products, sourced from sustainable forests, these classrooms demonstrate responsible construction and teach students about reducing carbon footprints.
- **Cost-Effective:** Unlike traditional extensions that can be time-consuming and expensive, eco classrooms offer a cost-effective, yet durable solution. They quickly add the much-needed extra space without compromising quality. Over time, they work out far more cost effective than Temporary Portable Buildings, as they have 4-6 times the lifespan of a typical portable cabin.
- **Flexibility in Design and Use:** Eco classrooms can be tailored to meet specific requirements. Whether used as classroom space, dining rooms, or for after school clubs, their versatility ensures they adapt to various needs.
- **Seamless Integration with Nature:** These classrooms blend harmoniously with outdoor surroundings, fostering a connection to the natural world. Learning in such an environment enhances critical social and emotional skills.
- **Speedy Construction:** Eco classrooms SIP Panels can be built off-site and installed conveniently during the summer holidays, minimising disruption.
- **Scalability for Growing Institutions:** As schools expand, eco classrooms can be easily added to accommodate increasing student numbers.

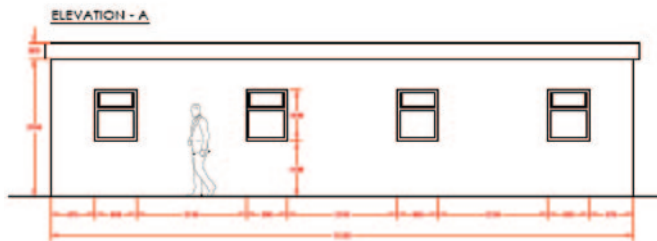
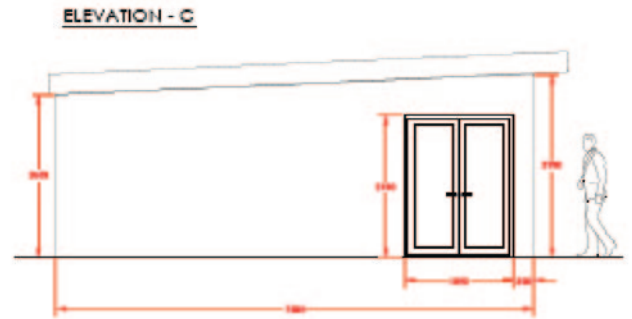
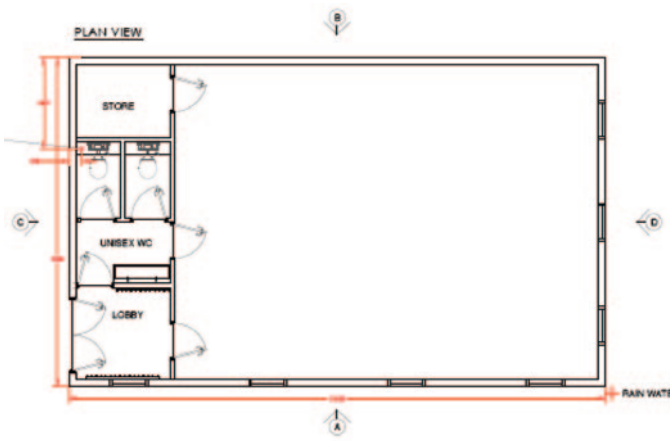



Washrooms

You might be surprised to know how many pupils (and parents) judge a school by its washrooms! A bright, colourful, hygienic and welcoming washroom environment can make a difference throughout the whole school.

Please contact us for details of the full range and for more advice.

Features & Options

- Fantastic selection of colour choices available
- Postformed vanity tops for fully-recessed or semi-recessed options
- Solid aluminium locks, hinges, headrail and adjustable feet
- Real high-pressure laminate face with impact resistant edging
- Ultimate durability
- Totally impervious to water
- Black profiled panel edges
- Low door and division height
- Option of print design doors
- Option of SGL or HPL core material



Washroom Accessories



Options & Accessories

We have a huge range of fixture and fitting options as well as our extensive range of colours, and materials.

- Heavy duty non slip vinyl provides a neat and cost effective flooring solution to wet areas
- Wall cladding uses matching material to the cubicles. It provides a cleanable robust surface with panels that can be removed if required
- Resin flooring uses a 3 layer system with metallic or mineral chips for durability & will not shrink or crack and is guaranteed for 25 years
- Ceramic tiles are ideal for washroom areas. There are a wide range of colours and sizes available, together with matching trims



Libraries & Learning Zones

Your new library or learning zone must provide efficient, practical and accessible storage of your learning resources. But if it is to fulfil its purpose it must also be attractive and welcoming for the pupils.

Please contact us for details of the full range and for more advice.

Page Link - see pages

For
Library
Furniture

210



- Huge range of shelving configurations, colours and finishes
- Choice of standard module sizes or bespoke
- Reading dens, benches and tables
- Flooring and décor design and installation



Staffrooms & Tea Points

Every school needs a quiet space for its staff. Offering a wide range of materials and finishes and backed up by our experience and expertise we ascertain exactly what you need – and build it for you.

- Large range of comfortable and relaxing seating units
- Armchairs, coffee tables
- Flooring and décor design and installation
- Worktops, sinks and storage

Please contact us for details of the full range and for more advice.



IT Suites

Thoughtfully planned and carefully executed, a good IT suite will give many years of service. We can design and build the complete suite, including fixtures, fittings and cabling for each station.

Please contact us for details of the full range and for more advice.

Page Link - see page

For IT
Furniture

162-177



- Flooring and décor design and installation
- Stylish and durable benching frames and tops
- Wide range of benching colours and finishes
- Range of chair designs and colours

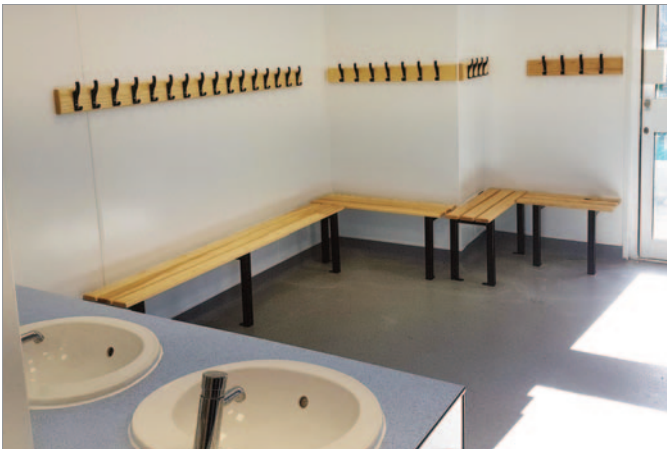

Cloakrooms & Changing Rooms

An area where intelligent design and robust construction are essential. We are able to design, plan and construct your cloakroom or changing room and complete it with all necessary fittings and storage lockers.

Page Link - see pages

For
Cloakroom
Furniture

148-161



- Flooring and décor design and installation
- Benching, racking and lockers
- Coat hooks

Please contact us for details of the full range and for more advice.



Reception Areas

With years of experience designing and fitting bespoke reception areas we can offer advice on every aspect of the process.

Even in the smallest and most awkward spaces we can deliver practical and beautiful solutions to suit your needs!

Please contact us for details of the full range and for more advice.

- Flooring and décor design and installation
- Wide range of reception desk styles, colour and finishes
- Fully bespoke design option available



Offices & Meeting Rooms

As well as our extensive ranges of office furniture featured in this catalogue, we can help you design, and build or refurbish your offices.

Our experienced designers use 2D and 3D CAD drawings to optimise your office space. Our skilled installation teams include electricians, joiners, plumbers and flooring fitters.

- Flooring and décor design and installation
- Range of desk styles, colours and finishes
- Range of chair designs and colours

Please contact us for details of the full range and for more advice.



Science Laboratories

- 16mm Trespa Toplab solid grade laminate worksurfaces
- Units come with MDF carcasses and laminate faced doors
- Turrets built and fitted to bespoke sizes for services including gas, water and electrics
- Removable back panels in base units allow access to pipework
- Full length steel drawer runners
- Vulcathene acid resistant waste pipework

- Grohe gas taps and water spouts
- Belfast sinks – range of sizes
- Large choice of surface colours and storage trays
- Matching furniture for Prep rooms
- Mobile steel tray storage
- Acid, poison and toxic chemical cabinets

Please contact us for details of the full range and for more advice.



Science

Laboratory Options

- Powerbars
- USB ports
- Laptop trays
- Cable trays
- PC shelves
- Learning walls
- 270 degree hinges to the doors
- Corian worksurface option
- Draining grooves for the sinks
- Fume cupboards, built in or mobile
- Blackout blinds for light experiments

Please contact us for details of the full range and for more advice.

Trespa Top Colours Options



Speckled
White



Speckled
Pastel Grey



Speckled
Powder Blue



Speckled
Aquamarine

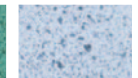

Speckled
Icy Blue



Home Economics

We offer a wide range of materials and finishes in all its configurations, whether you want wood finish, laminate or even Trespa, we can do it all.

- Optional bag stores
- 40mm Plexi-Form tops with D wrap laminate edging
- Ingredients storage units
- Fully integrated appliances if required
- Gas safe approved installation

- Warming drawers
- Corner carousels
- Extraction for adequate ventilation to regulation requirements
- Large range of colours of worksurfaces and finish options; units, floors, walls, stools
- Ask one of our Design Team to draw up a plan for your consideration

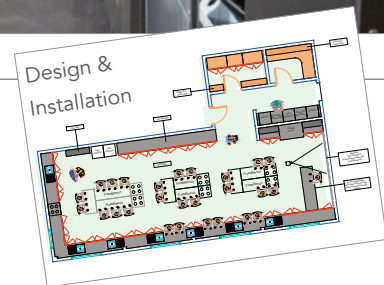



Classroom

Refurbishment

Classroom getting tired? Needing a new layout? Short of storage space? Staff and children getting depressed? The answer is to call us in to refit your classroom. We will strip it out, redecorate, give it new flooring, new storage equipment, new furniture, new ceiling and lighting. In short – a bright and enthusiastic atmosphere for the start of term.

- Flooring
- Ceiling and lighting
- Decorating
- Tables and chairs
- Built-in storage furniture
- Boards and interactive whiteboards
- Windows and blinds

Please contact us for details of the full range and for more advice.

LIFETIME
Warranty



Rapid-Build studio stage

The 'little' stage for your 'big' event.

No Obligation Free
Site Visit & Design

Assembly as simple as 1, 2, 3



Staging

& Auditorium Seating

All children love being 'on stage' at some point in their life, whether it be for a school performance, a presentation, or just to receive a reward. It can give them a real sense of achievement and a boost to their morale, but being in an audience that can't see the action, can be very frustrating.

Is your staging adequate enough to give both performers and audience the satisfaction they deserve? Our range of staging and auditorium seating can help you achieve this by elevating the pupils or having tiered seating for the audience. Please contact us for the best solution for you.

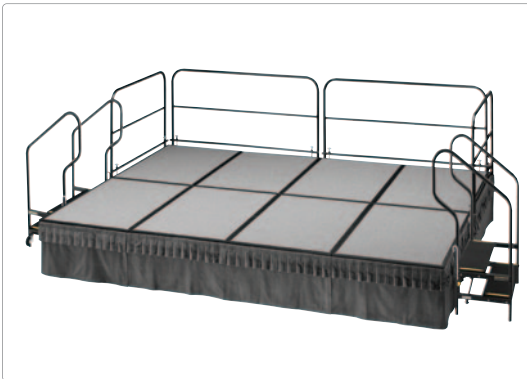
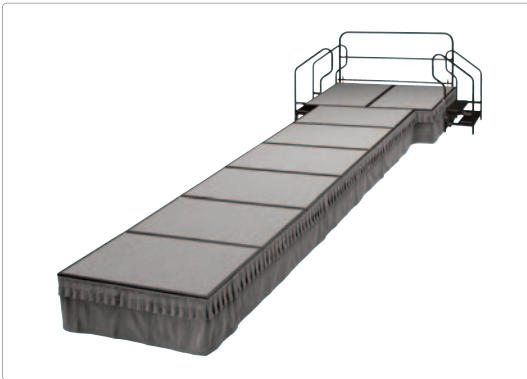

Easi-Fold Staging



Rapid Staging

Staging Options



Alu-Lite Staging



Outdoor Spaces

Let us transform your outdoor space into an interesting and engaging play and relaxation area. We can undertake all aspects of design and installation.

See pages 410-421 for outdoor furniture

Please contact us for details of the full range and for more advice.

- New hard and soft surfacing
- Fencing/walling
- Canopies
- Pergolas
- Gazebos
- Shade sails
- Play equipment
- Sheds and huts



Shelter & Shade

Outdoor Canopies & Shelters designed to suit your space

Adding a covered area to a school's outdoor space is a cost effective way to quickly optimise the efficiency of that space. It's now possible to learn and play outside in all weathers, while creating a focal point for the playground. Opt for natural, tactile timber or sturdy, low maintenance aluminium to enhance the school. A comfortable outdoor space also encourages more outdoor learning, which is proven to positively impact a child's social, emotional and physical wellbeing.

These products have been trusted by schools for years for safety, quality, durability, and great aesthetics. On offer is a comprehensive range of outdoor shelters to suit every budget and environment – whether you're looking for bike storage, a cost effective playground shelter or an all weather outdoor learning area, there is something to suit your budget and available space.



A. Timber cycle shelter and store

Includes Installation – POA

A sustainable shelter that also makes a serious statement. Not only bikes, but waiting parents can shelter here. Constructed with high quality, sustainably sourced timber anchored by steel posts, this shelter will fit in anywhere while adding a natural and multifunctional dimension to your outdoor space.

Velo Cycle Shelter

The Velo Cycle Shelters are timeless, durable, cost-effective, unobtrusive and quick to install. Available in a standard galvanised finish or galvanised and powder coated in the colour of your choice.

The Velo shelters can be designed and made to fit your exact space so that your bikes and scooters stay dry and protected.

Lux

Combining minimal, uncluttered aesthetics with an enviable array of child safety features, the Lux is the canopy of choice for many primary schools. With the gutters and downpipes hidden inside sturdy aluminium profiles the canopy is football-proof, looks great and is also inherently anti-climb. A certified non-fragile roof gives you peace of mind, while the hidden fixings and rounded finish reduce the possibility of injury in the case of a potential impact. Available with clear and coloured roof options, the canopy carries a 10 year guarantee. Standard finishes are RAL 7016 (dark grey) and RAL 9010 (white) – for other colours POA.

A – Standard lux shelters

Includes Installation - POA



B. Lux shelter with post protectors

Includes Installation - POA



C. Lux shelter with blinds

With enclosing blinds (weatherproof option)
Includes Installation - POA



Sailshade:

A simple and cost-effective way of introducing both colour and shade into an outdoor area. Use as single units or in combination to create a shade or delimit the playground into different areas. The playground isn't the only option – they also work well on a school field.



Timber playground shelter:

Perfect for outdoor learning, this high quality shelter with built in benches is constructed from sustainably sourced softwood. Its tactile and sheltered feel creates a refuge and favourite place for children and adults alike. Generous seating promotes inclusion and space for all.



We offer a complete bespoke service to meet your specific requirements.

Please ask for details

Prices are subject to a site survey and quotation.

A

Acoustic Surfaces	132,133,386, 388,389,392,405-409
Activity Rugs	118-119
Adjustable Tables	22,127,128,181,346,347
Alu Lite Staging	439
Art & Paper Storage	73,79,80, 81,95,108,110
Auditorium Seating	183,438
AV Cabinets	403

B

Baby Changing Units	110
Bean Bags	113,114,144,217
Beds, Dormitories	339-341
Benches, Outdoor	412-418

Bespoke Furniture

IT Suites	164-165
Libraries	204-206
Multiwall	91
Receptions	292-305
Storagewall	358-361
Bins	419-421

Boardroom Tables

Alpine	312-313
Barrel Top	313,334
Circular	312,335
Flip-top	311,333
Nova	314-316
Oval	334
Pole Leg Tables	312,313,332
Wilmington	334-335

Bookcases

Alpine X Storage Range	318-321
Arlington	343
Bookshelves	56,58,76,106, 206-212,338
Chalvington	348
Classtore Modular	95
Coloured Edge	58,
Desk High	348
Book Storage	56,58,76,95, 106,206-212,318-321,338,348
Break Out Seating	171-173,212-217, 240-245,250-251
Bubble Lamps	140-142
Bubble Walls	143
Built In Classroom Storage	94-95

C

Cable Management	346,354,355,357
Cafeteria Tables	183,195,198-199

Calstor

Classroom Trolleys	85
Flexible Storage	84
Library Storage	85
Cantilever Shelving	206

Carpets

Early Years	117-119
SEN	138

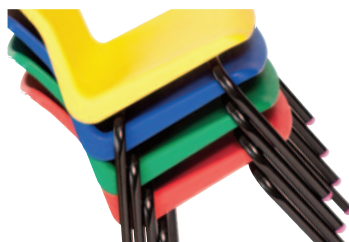
**Chairs**

Alyssa	231
Amaryllis	233
Anti Tilt	34
Aster	231
Atlas	29
Azalea	230
Breeze	254
Cantilever	30,38,192,255,259, 263,266,272,273,281,282,283
Cathedral	276
Chair Trolley	28,34,37,276, 277,278,279,281
Chevron	34,194
Chiltern	27
Classic Poly	28
Classroom	5,26-42
Dining	189-197
Eaton	169
Ergo	35
Ermington	197
Event	37
Flex	5,172-173
Flow	31,41,191
Folding	37
Forum	29
Geneva	193

Gorgio	264
Harlen	197
High Chairs	34,40,41,190,191,196,197
Highway	190
IT Chairs	166-173
Ivy	230
Juliette	229
La Rocca	193
Merlin	255
Metallique	196
Mobile+	171
Mono Posture	32,33,168
Oslo	195
Pagholtz	189
Pennine	36,40,168
Poly	26,27,28
Posture	5,29,32-36,167,168,172-173
Roma	33,192,278
Ruckus	171
Skagen	197
Skidbase	26,29,30,31,192, 22,237,245,276,279
Spar	196
Stacking	5,26,27,28,29,30, 31,33,34,35,38,127,171,190,192, 193,194,195,197,268,269,270,271, 272,273,274,276,278,279
Standfast	27
Stanza	195
Tamperproof	166,170
The Profile	30
Tuscany	190
Vivid	195
Vogue	166
Charge Lockers	174

Classroom Storage

Candy Colours	73-75
Classroom Step	72
Calstor	84-85
Cubes	72
Metal Tray Units	84-90
Tray Units	52-55,59-71,73, 77,79-80,81,84-90, 103,105,107,108,126
White Range	70-71
Classtore Modular Storage	94-95

Cloakroom & Washroom

Benching	150-151
Coat & Bag Racks	152-153
Early Years	152-153
Lockers	154-161
Cloakroom Trolleys	82,83,85

Coat Hooks & Rails	110,152,153
Coffee Tables	
Alpine	253
Metal Frame	232,237,242,252,253
Modular Units	112,226,227,231,252
Wilmington	252
Wooden	232,237
Computer Accessories	174-177,354-357
Conference Seating	268-283
Conference Tables	
Alpine	312-313
Nova	314-316
Wilmington	334-335
Coloured Edge Storage	
Bookcase & Cupboards	58,205,207
Tray Units	59
Coloured Filing Cabinet	363
COSSH Cupboards	368
Creative! Early Years Range	
Art Storage	110
Baby Changing Units	110
Bookcases	106
Dens	98
Kitchen Units	102
Role Play Panels	100-101
Storage Units	99,103-108
Tables & Chairs	109
Tray Units	103,105,106,107,108
Cupboards	
Alpine X Storage Range	319-321
Arlington	343
Chalvington	348
Classroom	55,57,58,68-69,73,75,80
Coloured Edge Storage	58
COSSH	368
Desk High	337,348
Open Bookcases	56,58,76,207,208, 209,318,319,320,321
Premium Range	68-69
Pigeon Hole	95,349,358,360
Steel Storage	362-373
Storage Wall	358-361
Tambour Cupboard	318,320,321,337, 338,348,358,365
Wooden Cupboards	55,57, 58,68-69,73,75,80,95, 105,318-321,337-338,340,343,348
Cushions	113,114,116
Cycle Racks	421
Cycle Shelters	442

D

Data Leads	355
Data & Power Modules	354,355
Design & Refurb	422-443
Desks	
Alpine	25,308
Arlington	342,343
Bench Desking	315-316
Cantilever Leg	25,165,310,322-325
Chalvington	346
Exam	44-45
Height Adjustable	22,346-347
Locker	23
Panel Leg	25,164,308-309,326-329,343
Reception	294-304
Sit-Stand	346
Teacher	24-25
Trolley	44
Vermont	347
Wilmington	25,294,322-331
Wooden	23-25,44-45, 164-165,308-310,315, 322-331,342-343,346-347

Dining Furniture

Benches	186,187
Bench Tables	186,187
Chairs	189-197



Fixed Seat Solutions	181-183
Folding Tables	181-183
Stools	189,190,196,197
Tables	180,186-188,198-199
Tilt Top	180
Trolley	188
Wall Pocket System	184-185

Display Panels

Folding	396,398
Heavy Duty	397
Lightweight	396
Mobile Room Dividers	399
Panel Bags	396
Pole and Panel	398
Tabletop	396,397
Dormitories	339-341
DuraStore Lockers	159

E

Early Years

Activity Rugs	118-119
Art Storage	73,79,80,81,110
Bean Bags	113,114,144
Book Storage	73,80,106,208-212
Carpets	117-119
Cloakroom	152-153
Cloakroom Trolleys	83,85
Creative! Range	98-109
Cushions	113,114,116
Height Adjustable Tables	127,128
Kinderbox Units	73,79,80,212
Mats	117-119
Nursery Chairs	109,112,127
Nursery Tables	109,127,128
Outdoor Learning	129
Paper Storage	80,108
Room Scene Kits	123
Role Play Panels	100-101
Rugs	117-119
Sand & Water Play	120-121
Sofas	112
Soft Seating	112-116
Stacking Storage	63,67,75
Storage Solutions	72-75,79, 99,103-108,110,125-126
Themed Cushions	113
Themed Nursery Seating	113,116
Themed Rugs	117-119
Tray Storage	73,103-109
Trolleys	83,85,116,126
Easels	98,110,122,125,382-383
Easi-Fold Staging	439
Eco Classrooms	424-425
Exam Desks	44-45
Executive Seating	264-265,282-283

F

Fabric Swatches	288-291
-----------------	---------

Filing Cabinets

Double Secure	373
Steel	362,363
Fire Resistant	373
Wooden	218,338,342

Filing Cupboards

Alpine X-Range	319-321
Double Secure	373
Fire Resistant	373
Steel	364-369,373
Wilmington	337-338,340
Flipchart Easels	382-383
Flip Top Desks	180,311,333
Floor Cushions	113,114,116
Folding Chairs	37

Folding Tables

Boardroom	311
Dining	181-183,186,187,188
Exam	44-45
Meeting	311,333
Training	311,333

G

Glass Magnetic Whiteboard	379
Glass Showcases	400,401
Gratnell's Trays	50
Grit Bin	419

H

HandiStor Storage	86-87
-------------------	-------

Height Adjustable Tables

Early Years	127,128
Classroom	22
Office	346-347
Hushboard Acoustic Tiles	404-409

I

IT Charge Lockers	174
-------------------	-----

IT Desking & Benching

Design & Fit-out	164-165,430
IT Desks	164-165
Laptop Unit	176-177
Nova Bench Desking	315-316
Wilmington Bench Desking	330-331
Workstations	164-165

IT Seating

Eaton	169
Flex	172-173

Flow IT Chair	166
IT Stool	167
IT Tamperproof	170
Mobile+ Chair	171
Mono Posture	168
Pennine	168
Positive Posture IT Chair	167
Profile Chair	166
Ruckus	171
Student Tamperproof	170
Vogue IT	166
IT Storage, Lapcabby	176-177
IT Suites	162-177

K

Kinderbox Units	73,79,80,212
Kitchen Play Sets	102
KomfiTub Children's Seating	112

L

Laptop Charging	174-175,177
Laptop Storage	174-177
Lecterns	402

Leather Chairs

Conference	282-283
Managers	264-265
Reception Seating	234,239
Tub	234

Library Furniture

Cantilever Shelving	206
Coloured Storage	205,207,208,209,211,212
Coniston Shelving	207
Dynamix Library Shelving	205
Grasmere Curved Storage	207
Kandi	208
Library Seating	212-219
Light Box	98,99
Light & Sound (SEN)	134-137

Lockers

Cube	158
Dangerous Substance	369
Durastore	159
Janitorial	158
Laptop Charging	174-175,177
Mylockers	160-161
Phone	158
Plastic	159
Steel	154-158,160-161
Lunchbox Trolleys	82-83

M

Magnetic Boards	104,122,376,378-379,381,382,383
Mats	117-119
Meeting Tables	312-314,334-335,350-351
Mesh Back Chairs	257,258,259,267,270,273,281
Metal Cupboards	364-369,373
Metal Pedestals	370
Metal Tray Storage	81,84-90
Modular Seating	112,212,213,215-217,224-227,240-245,250,251
Monitor Arms	353,356
Multi Drawer Cabinets	362
Multi Sensory Environments	132-133
Multiwall	91
Music Trolley	81

N**Noticeboards**

Aluminium Frame Cork	387,395
Aluminium Frame Felt	387
Exterior	394-395
Felt Boards	386,387,389
Fire Retardant	386,388,389,392,393
Tamperproof Lockable	389-390
Unframed	386
Nursery Chairs	109,127,
Nursery Furniture	103-115,125-128
Nursery Tables	109,127,128

O

Office Chairs	254-283
---------------	---------

Office Desking

Alpine	308-310
Executive Desking	324-325,328-329
Nova Desking	315-316
Wilmington	322-331
Operator Chairs	254-259

Outdoor Furniture

Bins	419-421
Canopies	442-443
Cotswold Concrete & Wood Range	415
Cycle Racks	421
Grit Bin	419
Lockers	159
Outdoor Seating	412-418
Picnic Benches	412-414,415,417

Recycled Benches	416,417
Shelters/Canopies	442-443
Wooden Benches	412-415,416
Outdoor Play	129

P

Paper Storage	80,95
Pedestals	
Metal	370
Wooden	317,336,342
Picnic Benches	
Stone Effect	417
Wooden	412-416
Pigeon Hole Units	95,349
Storage Wall	358
Plan Chests	80,108
Plants	305
Plastic Storage Trays	48-50
Play Corners	123
Power Modules	354
Premium Storage Range	68-69
Presentation & Display	
Display Cases	400-401
Display Panels	396-399
Flipchart Easels	122,382-383
Hushboard	406-407
Mobile Room Dividers	399
Noticeboards	379,386-395
Whiteboards	376-378,380-381
Projection Screens	91,384

R

Rapid-Build Staging	438
Reception Furniture	292-304
Reception Seating	224-251
Refurbishment	422-443
Retreat Booths	218,219,246-249

S

Safes	
Electronic Safe	371,372
Fire Resistant Media Safe	372
Key	371
Sand & Water Play	120-121
Screens	
Desk Mounted	304,352,353
Floor Standing	352
Interactive	385

Projection	384
Seating	
Backcare Chairs	266-267
Café Seating	193,195-197
Conference Seating	268-283
Early Years Seating	112-115
Fabric Swatches	288-291
High Back Sofas	240-241,243-245
Library Seating	212-219
Managers/Executive Chairs	264-265
Meeting/Conference Chairs	268-283
Mesh Back	257,258,259,267,270,273,281
Modular Seating	112,212,213,215-217,224-227,240-245,250,251
Operator Seating	254-259
Pouffes	113,114,115
Reception Seating	292-304
Reception Steel Frame	228-232,236-237
Seating Dimensions	284-287
Seating Index	222-223
Staffroom Seating	224-247
Sofas	112,224-228,232-235,238-239
Task Chairs	260-263
Tubs	234-235
Secure Storage	
Cupboards	373
Fire Resistant Safe	372
Safes	371-372



SEN	130-147
Bubble Lamps	140-142
Bubble Walls	143
Light & Sound	134-137,138,139
Multi-Sensory Environments	132-133
Sensory Toys	146-147
Soft Play	144-145
Sensory Toys	146-147
Shelving	344-345

Showcases

External	394-395
Fire Resistant	392,393
Glass Display Cases	400-401
Interior	391
Side Opening Tambours	318,320,321,337,338,348,358,365
Sink Unit	95
Sofas	112,224-228,232-235,238-239
Soft Seating	112-116,213-217,224-251
Staging & Auditorium	438-439
Staffroom Seating	224-247

Steel Storage

Dangerous Substances	369
Filing Cabinets	362,363,373
Lockers	154-158,160-161
Multidrawer Units	362
Pedestals	370
Safes	371-372
Storage Cupboards	364-369,373
Tambour Cupboard	365
TecniStor Tray Storage	88-90

Stools

Active Balance	42
Beech	39
Chevron	34
Dining	182-183,189,190,191,196,197
Eaton	169
Expression	196
Fusion	279
Graduate Cantilever	38
Harlen	197
IT	167
Metallic	196
Molde	280
Mono	41
Mono Posture	168
Narvik	280
Olympic	38
Pennine Posture	40
Readingzone	215
Rectangular	40
Skagen	197
Skid Base	39
Society	275
Spar	196
Stacking	34,38,40,41
Student Lipped	39
Upholstered	42
Wooden	39

Storage

Alpine Office	317-318,319-321
Arlington	342,343
Bag Storage	77,153
Calstor Classroom Trolleys	85
Calstor Flexible Storage	84
Calstor Library Storage	85
Candy Colours Units	73-75
Chalvington	348-349
Charging Lockers	174-175
Classtor Modular Storage	94-95
Colorstore	78
Coloured Edge Storage	58,59,205
Early Years Storage	72-75,79, 99,103-108,110,125-126
Fire Resistant Filing Cabinets	373
Grasmere Book Storage	207
HandiStor	86-87
Kinderbox	73,79,80,212
Lapcabby	176-177
Laptop Charging Locker	174-175,177
Locking Secure Filing Cabinets	373
Metal Storage	363-373
Multidrawer	362
Paper Storage Unit	80,95,
Pedestals	317,336,342,370
Pigeon Hole Units	95,349,358
Premium Range	68-69
Safes	371-372
Sports Trolley	81
Steel Storage	363-373
Storage Cupboards	55,57,58,68-69, 73,75,80,105,318-321, 337-338,340,343,348
Storage Trays	48-50
Storage Trolleys	81-86,90
Storage Wall	358-361
Tambour Cupboards	318,320,321, 337,338,348,358,365



TecniStor	88-90
Tray Storage Units	52-55,59-73, 77,79-80,84-90,99,103-108,125-126

Trays	48-50
Wooden Filing Cabinets	318,338,342
Storage Trolley	
Art Trolley	81,125
Cloakroom Trolley	83,85
Exam Chair Trolley	37
Exam Desk Trolley	44
Lunchbox Trolley	82,83,85
Music Trolley	81
Sports Trolley	81
Transporting	81
Study Booths	43

T**Tables**

Arundel	351
Cantilever	25
Classroom	6-19
Clover	7,127,128
Conference Tables	312-316,334-335
Coffee Tables	112,226,231,232, 237,242,252-253
Craft	20
Creative Cluster	6-7
Crushbent	9,14-16
Diamond	6
Exam	44-45
Fully Welded	8,10-13,17-19
Heavy Duty	8
Height Adjustable Tables	22,127, 128,346-347
Meeting	312-314,334-335,350-351
Nursery	109,127,128
Outdoor	412-414,415,417
Premium	10-11
Primary	10
Project	20-21
Stacking	5,7,9,12-17
Stax	5
Table Height Guidance	4
Tilt Top	180,311,333
Tray	18-19
Tambour Cupboards	318,320,321,337, 338,348,358,365
Task Chairs	260-263
Teacher Cupboards	367
Teaching Wall	92-93
TecniStor Storage	88-90
Transporting Trolley	81
Tray Storage Units	52-55,59-73,77, 79-80,84-90,99,103-108,125-126

Tray Tables	18-19
-------------	-------

Trolley

Chair Trolley	28,34,37
Cloakroom Trolley	83,85
Continuous Provision	99
Exam Desk Trolley	44
Lunchbox Trolley	82,83,85
Sports Trolley	81
Transporting	81

Tilt Top Tables

Dining	180
Tilt-Top	311,333

W**Wall Storage**

Multiwall	91
Teaching Wall	92-93

Washrooms

Accessories	426-427
Coat & Bag Racks	77,82,83,85,152,153

Whiteboards

Coloured Edge	377
Gridded Boards	376
Mobile Whiteboards	380
Magnetic	376
Magnetic Glass	379
Non-Magnetic	376
Revolving Whiteboards	381
Table Tops	11

Wilmington Furniture Range

Bench Desking	330-331
Boardroom Tables	334
Coffee Tables	252
Desks	322-329
Meeting & Poseur Tables	332,335,350
Pigeon Hole Units	349
Residential	339-341
Storage	336-338
Tilt Top Tables	333

Work Benches	20-21
--------------	-------

Prices and product availability may vary during the lifetime of this catalogue. Please contact us to confirm at time of order.

We come to you...

At Parkmere we offer a free planning service. Let us help prepare room designs for **you** to create the **perfect** solution for your space.

Ask for a **free consultation**...

Terms & Conditions

Terms of Payment

Within 30 days from date of invoice, unless we have agreed otherwise in writing.

Retention of Title

All goods supplied remain the property of Parkmere, until all payment of these goods has been made in full.

Products

We reserve the right to alter any details of prices or products illustrated without notice.

Samples

Because most products are manufactured specially for the customer, samples are not normally available.

Delivery

Whilst we make every effort to meet the quoted approximate delivery date we cannot be held responsible for the manufacturer's failure to meet their estimated delivery date. Also, once delivered, these goods are then deemed to be non-returnable.

Carriage

Orders worth less than £300 (ex VAT) may incur a carriage charge.

Claims

Claims for damage or loss of goods must be made in writing within 48 hours of delivery.

Cancellation

Because most furniture is manufactured specially on behalf of the customer, cancellation of an order is only acceptable within 48 hours of the order being placed. Where an order includes the cutting of fabrics this cancellation period is reduced to 24 hours. After this period a cancellation charge may apply.

Prices

All prices shown are subject to VAT at the current rate. We will do everything we possibly can to hold prices listed for the duration of the catalogue, but we reserve the right to change prices if circumstances arise beyond our control.

Step 1

Free site visit and space planning.



Step 2

A personalised quotation and design.



Step 3

Delivery and installation of your furniture.



Step 4

Your inspiring environment created.



parkmere

educational & office furniture

Inspiring Solutions

T: 024 7710 3777

E: sales@parkmere.com

W: www.parkmere.com



Helping you achieve
inspiring environments